



fordowner.com



ford.ca

2015 **F-150** Owner's Manual



August 2015
Fourth Printing
Owner's Manual
F-150
Litho in U.S.A.



PMFL3J 19A321 AA



The information contained in this publication was correct at the time of going to print. In the interest of continuous development, we reserve the right to change specifications, design or equipment at any time without notice or obligation. No part of this publication may be reproduced, transmitted, stored in a retrieval system or translated into any language in any form by any means without our written permission. Errors and omissions excepted.

© Ford Motor Company 2015

All rights reserved.

Part Number: 20150724195722

Table of Contents

Introduction

About This Manual.....	7
Symbols Glossary.....	7
Data Recording.....	9
California Proposition 65.....	11
Perchlorate.....	11
Ford Credit.....	11
Replacement Parts Recommendation.....	11
Special Notices.....	12
Mobile Communications Equipment.....	13
Export Unique Options.....	13

Environment

Protecting the Environment.....	14
---------------------------------	----

Child Safety

General Information.....	15
Installing Child Restraints.....	16
Booster Seats.....	28
Child Restraint Positioning.....	30
Child Safety Locks.....	31

Seatbelts

Principle of Operation.....	33
Fastening the Seatbelts.....	34
Seatbelt Height Adjustment.....	38
Seatbelt Warning Lamp and Indicator Chime.....	39
Seatbelt Reminder.....	39
Child Restraint and Seatbelt Maintenance.....	41

Personal Safety System™

Personal Safety System™.....	42
------------------------------	----

Supplementary Restraints System

Principle of Operation.....	43
-----------------------------	----

Driver and Passenger Airbags.....	44
Front Passenger Sensing System.....	45
Side Airbags.....	47
Safety Canopy™.....	48
Crash Sensors and Airbag Indicator.....	49
Airbag Disposal.....	50

Keys and Remote Controls

General Information on Radio Frequencies.....	51
Remote Control.....	51
Replacing a Lost Key or Remote Control.....	56

MyKey™

Principle of Operation.....	57
Creating a MyKey.....	58
Clearing All MyKeys.....	58
Checking MyKey System Status.....	59
Using MyKey With Remote Start Systems.....	60
MyKey Troubleshooting.....	60

Locks

Locking and Unlocking.....	62
Keyless Entry.....	64

Security

Passive Anti-Theft System.....	67
Anti-Theft Alarm.....	69

Power Running Boards

Using Power Running Boards.....	71
---------------------------------	----

Steering Wheel

Adjusting the Steering Wheel.....	73
Audio Control.....	74
Voice Control.....	75
Cruise Control.....	75
Information Display Control.....	76

Table of Contents

Pedals

Adjusting the Pedals.....	77
---------------------------	----

Wipers and Washers

Windshield Wipers.....	78
Autowipers.....	78
Windshield Washers.....	79

Lighting

Lighting Control.....	80
Autolamps.....	80
Instrument Lighting Dimmer.....	81
Daytime Running Lamps.....	82
Automatic High Beam Control.....	82
Front Fog Lamps.....	84
Direction Indicators.....	84
Spot Lamps.....	84
Interior Lamps.....	85
Ambient Lighting.....	87

Windows and Mirrors

Power Windows.....	88
Exterior Mirrors.....	89
Interior Mirror.....	93
Sun Visors.....	93
Moonroof.....	93

Instrument Cluster

Gauges.....	95
Warning Lamps and Indicators.....	98
Audible Warnings and Indicators.....	102

Information Displays

General Information.....	103
Information Messages.....	118

Climate Control

Manual Climate Control.....	131
Automatic Climate Control.....	133

Hints on Controlling the Interior

Climate.....	134
Heated Windows and Mirrors.....	137
Cabin Air Filter.....	137
Remote Start.....	138

Seats

Sitting in the Correct Position.....	139
Head Restraints.....	139
Manual Seats.....	141
Power Seats.....	142
Memory Function.....	144
Rear Seats.....	146
Heated Seats.....	146
Climate Controlled Seats.....	147
Front Seat Armrest.....	149
Rear Seat Armrest.....	149

Universal Garage Door Opener

Universal Garage Door Opener.....	150
-----------------------------------	-----

Auxiliary Power Points

Auxiliary Power Points.....	154
-----------------------------	-----

Storage Compartments

Center Console.....	156
Overhead Console.....	157

Starting and Stopping the Engine

General Information.....	158
Ignition Switch.....	158
Keyless Starting.....	158
Starting a Gasoline Engine.....	159
Engine Block Heater.....	162

Unique Driving Characteristics

Auto-Start-Stop.....	164
----------------------	-----

Table of Contents

Fuel and Refueling

Safety Precautions.....	166
Fuel Quality.....	167
Running Out of Fuel.....	168
Refueling.....	169
Fuel Consumption.....	170
Emission Control System.....	171

Transmission

Automatic Transmission.....	174
-----------------------------	-----

Four-Wheel Drive

Using Four-Wheel Drive.....	180
-----------------------------	-----

Rear Axle

Electronic Locking Differential.....	188
--------------------------------------	-----

Brakes

General Information.....	190
Hints on Driving With Anti-Lock Brakes.....	190
Parking Brake.....	190
Electric Parking Brake.....	191
Hill Start Assist.....	193

Traction Control

Principle of Operation.....	195
Using Traction Control.....	195

Stability Control

Principle of Operation.....	196
Using Stability Control.....	197

Terrain Response

Principle of Operation.....	199
Using Hill Descent Control.....	199

Parking Aids

Parking Aid.....	201
------------------	-----

Active Park Assist.....	202
Rear View Camera.....	206
360 Degree Camera.....	209

Cruise Control

Principle of Operation.....	212
Using Cruise Control.....	212
Using Adaptive Cruise Control.....	213

Driving Aids

Driver Alert.....	220
Lane Keeping System.....	220
Blind Spot Information System.....	224
Cross Traffic Alert.....	226
Steering.....	229
Collision Warning System.....	230

Load Carrying

Load Limit.....	233
Tailgate.....	239

Towing

Towing a Trailer.....	249
Trailer Sway Control.....	250
Recommended Towing Weights.....	250
Essential Towing Checks.....	261
Towing Points.....	268
Transporting the Vehicle.....	269
Towing the Vehicle on Four Wheels.....	269

Driving Hints

Breaking-In.....	272
Economical Driving.....	272
Driving Through Water.....	273
Floor Mats.....	273
Snowplowing.....	274

Roadside Emergencies

Roadside Assistance.....	277
--------------------------	-----

Table of Contents

Hazard Warning Flashers.....	278
Fuel Shutoff.....	278
Jump Starting the Vehicle.....	279
Post-Crash Alert System.....	281

Customer Assistance

Getting the Services You Need.....	282
In California (U.S. Only).....	283
The Better Business Bureau (BBB) Auto Line Program (U.S. Only).....	284
Utilizing the Mediation/Arbitration Program (Canada Only).....	285
Getting Assistance Outside the U.S. and Canada.....	285
Ordering Additional Owner's Literature.....	286
Reporting Safety Defects (U.S. Only).....	287
Reporting Safety Defects (Canada Only).....	287

Fuses

Fuse Specification Chart.....	289
Changing a Fuse.....	297

Maintenance

General Information.....	298
Opening and Closing the Hood.....	298
Under Hood Overview - 2.7L EcoBoost™.....	299
Under Hood Overview - 3.5L EcoBoost™.....	300
Under Hood Overview - 3.5L.....	301
Under Hood Overview - 5.0L.....	302
Engine Oil Dipstick.....	303
Engine Oil Check.....	303
Engine Coolant Check.....	304
Automatic Transmission Fluid Check.....	308
Transfer Case Fluid Check.....	308
Brake Fluid Check.....	309

Power Steering Fluid Check.....	309
Washer Fluid Check.....	309
Fuel Filter.....	309
Changing the 12V Battery.....	309
Checking the Wiper Blades.....	311
Changing the Wiper Blades.....	311
Adjusting the Headlamps.....	312
Changing a Bulb.....	313
Bulb Specification Chart.....	318
Changing the Engine Air Filter.....	320

Vehicle Care

General Information.....	321
Cleaning Products.....	321
Cleaning the Exterior.....	321
Waxing.....	322
Cleaning the Engine.....	323
Cleaning the Windows and Wiper Blades.....	323
Cleaning the Interior.....	324
Cleaning the Instrument Panel and Instrument Cluster Lens.....	324
Cleaning Leather Seats.....	325
Repairing Minor Paint Damage.....	326
Cleaning the Alloy Wheels.....	326
Vehicle Storage.....	327

Wheels and Tires

General Information.....	329
Tire Care.....	331
Using Snow Chains.....	346
Tire Pressure Monitoring System.....	347
Changing a Road Wheel.....	352
Technical Specifications.....	360

Capacities and Specifications

Engine Specifications.....	361
Motorcraft Parts.....	362
Vehicle Identification Number.....	362

Table of Contents

Vehicle Certification Label.....	363	Information.....	476
Transmission Code Designation.....	364	Climate.....	485
Capacities and Specifications - 2.7L EcoBoost™.....	365	Navigation.....	488
Capacities and Specifications - 3.5L EcoBoost™.....	369	Accessories	
Capacities and Specifications - 3.5L.....	373	Accessories.....	497
Capacities and Specifications - 5.0L.....	378	Extended Service Plan (ESP)	
Audio System		Extended Service Plan (ESP).....	499
General Information.....	383	Scheduled Maintenance	
Audio Unit - Vehicles With: AM/FM.....	384	General Maintenance Information.....	501
Audio Unit - Vehicles With: AM/FM/ CD.....	386	Normal Scheduled Maintenance.....	504
Audio Unit - Vehicles With: AM/FM/ SYNC.....	389	Special Operating Conditions Scheduled Maintenance.....	507
Audio Unit - Vehicles With: AM/FM/CD/ SYNC/Satellite Radio.....	391	Scheduled Maintenance Record.....	510
Audio Unit - Vehicles With: Sony AM/FM/ CD.....	393	Appendices	
Digital Radio.....	395	End User License Agreement.....	520
Satellite Radio.....	397	Type Approvals.....	535
Audio Input Jack.....	400		
USB Port.....	400		
Media Hub.....	401		
SYNC™			
General Information.....	402		
Using Voice Recognition.....	404		
Using SYNC™ With Your Phone.....	406		
SYNC™ Applications and Services.....	416		
Using SYNC™ With Your Media Player.....	420		
SYNC™ Troubleshooting.....	427		
MyFord Touch™			
General Information.....	436		
Settings.....	443		
Entertainment.....	453		
Phone.....	470		

Introduction

ABOUT THIS MANUAL

Thank you for choosing Ford. We recommend that you take some time to get to know your vehicle by reading this manual. The more that you know about your vehicle, the greater the safety and pleasure you will get from driving it.

WARNING



Driving while distracted can result in loss of vehicle control, crash and injury. We strongly recommend that you use extreme caution when using any device that may take your focus off the road. Your primary responsibility is the safe operation of your vehicle. We recommend against the use of any hand-held device while driving and encourage the use of voice-operated systems when possible. Make sure you are aware of all applicable local laws that may affect the use of electronic devices while driving.

Note: This manual describes product features and options available throughout the range of available models, sometimes even before they are generally available. It may describe options not fitted to the vehicle you have purchased.

Note: Some of the illustrations in this manual may show features as used in different models, so they may appear different to you on your vehicle.

Note: Always use and operate your vehicle in line with all applicable laws and regulations.

Note: Pass on this manual when selling your vehicle. It is an integral part of your vehicle.

This manual may qualify the location of a component as left-hand side or right-hand side. The side is determined when facing forward in the seat.

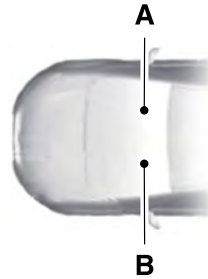

E154903

A Right-hand side.

B Left-hand side.

SYMBOLS GLOSSARY

These are some of the symbols you may see on your vehicle.



Safety alert



See Owner's Manual



Air conditioning system



Anti-lock braking system



Avoid smoking, flames or sparks



Battery



Battery acid



Brake fluid - non petroleum based

Introduction



Brake system



Cabin air filter



Check fuel cap



Child safety door lock or unlock



Child seat lower anchor



Child seat tether anchor



Cruise control



Do not open when hot



Engine air filter



Engine coolant



Engine coolant temperature



Engine oil



Explosive gas



Fan warning



Fasten seatbelt



Front airbag



Front fog lamps



Fuel pump reset



Fuse compartment



Hazard warning flashers



Heated rear window



Heated windshield



Interior luggage compartment release



Jack



Keep out of reach of children



Lighting control



Low tire pressure warning



Maintain correct fluid level



Note operating instructions



Panic alarm

Introduction



Parking aid



Parking brake



Power steering fluid



Power windows front/rear



Power window lockout



Service engine soon



Side airbag



Shield the eyes



Stability control



Windshield wash and wipe

DATA RECORDING

Service Data Recording

Service data recorders in your vehicle are capable of collecting and storing diagnostic information about your vehicle. This potentially includes information about the performance or status of various systems and modules in the vehicle, such as engine, throttle, steering or brake systems. In order to properly diagnose and service your vehicle, Ford Motor Company, Ford of Canada, and service and repair

facilities may access or share among them vehicle diagnostic information received through a direct connection to your vehicle when diagnosing or servicing your vehicle. Additionally, when your vehicle is in for service or repair, Ford Motor Company, Ford of Canada, and service and repair facilities may access or share among them data for vehicle improvement purposes. For U.S. only (if equipped), if you choose to use the SYNC Vehicle Health Report, you consent that certain diagnostic information may also be accessed electronically by Ford Motor Company and Ford authorized service facilities, and that the diagnostic information may be used for any purpose. See **SYNC™** (page 402).

Event Data Recording

This vehicle is equipped with an event data recorder. The main purpose of an event data recorder is to record, in certain crash or near crash-like situations, such as an airbag deployment or hitting a road obstacle; this data will assist in understanding how a vehicle's systems performed. The event data recorder is designed to record data related to vehicle dynamics and safety systems for a short period of time, typically 30 seconds or less.

The event data recorder in this vehicle is designed to record such data as:

- **How various systems in your vehicle were operating;**
- **Whether or not the driver and passenger safety belts were buckled/fastened;**
- **How far (if at all) the driver was depressing the accelerator and/or the brake pedal; and**
- **How fast the vehicle was traveling; and**
- **Where the driver was positioning the steering wheel.**

Introduction

This data can help provide a better understanding of the circumstances in which crashes and injuries occur.

Note: *Event data recorder data is recorded by your vehicle only if a non-trivial crash situation occurs; no data is recorded by the event data recorder under normal driving conditions and no personal data or information (e.g., name, gender, age, and crash location) is recorded (see limitations regarding 911 Assist and Traffic, directions and Information privacy below). However, parties, such as law enforcement, could combine the event data recorder data with the type of personally identifying data routinely acquired during a crash investigation.*

To read data recorded by an event data recorder, special equipment is required, and access to the vehicle or the event data recorder is needed. In addition to the vehicle manufacturer, other parties, such as law enforcement, that have such special equipment, can read the information if they have access to the vehicle or the event data recorder. Ford Motor Company and Ford of Canada do not access event data recorder information without obtaining consent, unless pursuant to court order or where required by law enforcement, other government authorities or other third parties acting with lawful authority. Other parties may seek to access the information independently of Ford Motor Company and Ford of Canada.

Note: *Including to the extent that any law pertaining to Event Data Recorders applies to SYNC or its features, please note the following: Once 911 Assist (if equipped) is enabled (set ON), 911 Assist may, through any paired and connected cell phone, disclose to emergency services that the vehicle has been in a crash involving the deployment of an airbag or, in certain vehicles, the activation of the fuel pump shut-off. Certain versions or updates to 911 Assist may also be capable of being used to electronically or verbally provide to 911 operators the vehicle location (such as latitude and longitude), and/or other details about the vehicle or crash or personal information about the occupants to assist 911 operators to provide the most appropriate emergency services. If you do not want to disclose this information, do not activate the 911 Assist feature. See SYNC™ (page 402).*

Additionally, when you connect to Traffic, Directions and Information (if equipped, U.S. only), the service uses GPS technology and advanced vehicle sensors to collect the vehicle's current location, travel direction, and speed ("vehicle travel information"), only to help provide you with the directions, traffic reports, or business searches that you request. If you do not want Ford or its vendors to receive this information, do not activate the service. For more information, see Traffic, Directions and Information, Terms and Conditions. See SYNC™ (page 402).

Introduction

CALIFORNIA PROPOSITION 65

WARNINGS



Some constituents of engine exhaust, certain vehicle components, certain fluids contained in vehicles and certain products of component wear contain or emit chemicals known to the State of California to cause cancer and birth defects or other reproductive harm.



Battery posts, terminals and related accessories contain lead and lead compounds, chemicals known to the State of California to cause cancer and reproductive harm. Batteries also contain other chemicals known to the State of California to cause cancer. Wash your hands after handling.

PERCHLORATE

Certain components in your vehicle such as airbag modules, safety belt pretensioners and remote control batteries may contain perchlorate material. Special handling may apply for service or vehicle end of life disposal.

For more information visit:

Web Address
www.dtsc.ca.gov/hazardouswaste/perchlorate

FORD CREDIT

(U.S. Only)

Ford Credit offers a full range of financing and lease plans to help you acquire your vehicle. If you have financed or leased your vehicle through Ford Credit, thank you for your business.

For your convenience we offer a number of ways to contact us, as well as to help manage your account.

Phone: 1-800-727-7000

For more information regarding Ford Credit, as well as to access Account Manager, please go to www.fordcredit.com.

REPLACEMENT PARTS RECOMMENDATION

Your vehicle has been built to the highest standards using quality parts. We recommend that you demand the use of genuine Ford and Motorcraft parts whenever your vehicle requires scheduled maintenance or repair. You can clearly identify genuine Ford and Motorcraft parts by looking for the Ford, FoMoCo or Motorcraft branding on the parts or their packaging.

Scheduled Maintenance and Mechanical Repairs

One of the best ways for you to make sure that your vehicle provides years of service is to have it maintained in line with our recommendations using parts that conform to the specifications detailed in this Owner's Manual. Genuine Ford and Motorcraft parts meet or exceed these specifications.

Collision Repairs

We hope that you never experience a collision, but accidents do happen. Genuine Ford replacement collision parts meet our stringent requirements for fit, finish, structural integrity, corrosion protection and dent resistance. During vehicle

Introduction

development we validate these parts deliver the intended level of protection as a whole system. A great way to know for sure you are getting this level of protection is to use genuine Ford replacement collision parts.

Warranty on Replacement Parts

Genuine Ford and Motorcraft replacement parts are the only replacement parts that benefit from a Ford Warranty. Damage caused to your vehicle as a result of the failure of non-Ford parts may not be covered by the Ford Warranty. For additional information, refer to the terms and conditions of the Ford Warranty.

SPECIAL NOTICES

New Vehicle Limited Warranty

For a detailed description of what is covered and what is not covered by your vehicle's New Vehicle Limited Warranty, refer to the Warranty Manual that is provided to you along with your Owner's Manual.

Special Instructions

For your added safety, your vehicle is fitted with sophisticated electronic controls.

WARNINGS



Failure to follow the specific warnings and instructions could result in personal injury. See

Supplementary Restraints System (page 43).



Front seat mounted rear-facing child or infant seats should **NEVER** be placed in front of an active passenger airbag.

On-board Diagnostics (OBD-II)

Your vehicle's On-board Diagnostics (OBD-II) system has a data port for diagnostics, repair and reprogramming services with diagnostic scan tools. Installing a non-Ford-approved aftermarket OBD plug-in device that uses the port during normal driving, for example remote insurance company monitoring, remote vehicle diagnostics, telematics or engine reprogramming, may cause interference or damage to vehicle systems. We do not recommend or endorse the use of any non-Ford-approved aftermarket OBD plug-in devices. The vehicle Warranty may not cover damage caused by any non-Ford-approved aftermarket OBD plug-in device.

Notice to owners of pickup trucks and utility type vehicles

WARNING



Utility vehicles have a significantly higher rollover rate than other types of vehicles.

Before you drive your vehicle, please read this Owner's Manual carefully. Your vehicle is not a passenger car. As with other vehicles of this type, failure to operate your vehicle correctly may result in loss of vehicle control, vehicle rollover, personal injury or death.

Using your vehicle with a snowplow

See **Snowplowing** (page 274).

Using your vehicle as an ambulance

Do not use this vehicle as an ambulance. Your vehicle is not equipped with the Ford Ambulance Preparation Package.

Introduction

MOBILE COMMUNICATIONS EQUIPMENT

Using mobile communications equipment is becoming increasingly important in the conduct of business and personal affairs. However, you must not compromise your own or others' safety when using such equipment. Mobile communications can enhance personal safety and security when appropriately used, particularly in emergency situations. Safety must be paramount when using mobile communications equipment to avoid negating these benefits. Mobile communication equipment includes, but is not limited to, cellular phones, pagers, portable email devices, text messaging devices and portable two-way radios.

WARNING



Driving while distracted can result in loss of vehicle control, crash and injury. We strongly recommend that you use extreme caution when using any device that may take your focus off the road. Your primary responsibility is the safe operation of your vehicle. We recommend against the use of any hand-held device while driving and encourage the use of voice-operated systems when possible. Make sure you are aware of all applicable local laws that may affect the use of electronic devices while driving.

EXPORT UNIQUE OPTIONS

For your particular global region, your vehicle may be equipped with features and options that are different from the features and options that are described in this Owner's Manual. A market unique supplement may be supplied that complements this book. By referring to the market unique supplement, if provided, you can properly identify those features, recommendations and specifications that

are unique to your vehicle. This Owner's Manual is written primarily for the U.S. and Canadian Markets. Features or equipment listed as standard may be different on units built for Export. **Refer to this Owner's Manual for all other required information and warnings.**

Environment

PROTECTING THE ENVIRONMENT

You must play your part in protecting the environment. Correct vehicle usage and the authorized disposal of waste, cleaning and lubrication materials are significant steps toward this aim.

Child Safety

GENERAL INFORMATION

See the following sections for directions on how to properly use safety restraints for children.

WARNINGS



Always make sure your child is secured properly in a device that is appropriate for their height, age and weight. Child safety restraints must be bought separately from your vehicle. Failure to follow these instructions and guidelines may result in an increased risk of serious injury or death to your child.



All children are shaped differently. The recommendations for safety restraints are based on probable child height, age and weight thresholds from National Highway Traffic Safety Administration and other safety organizations, or are the minimum requirements of law. Ford recommends checking with a NHTSA Certified Child Passenger Safety Technician (CPST) and consult your pediatrician to make sure your child seat is appropriate for your child, and

WARNINGS

is compatible with and properly installed in your vehicle. To locate a child seat fitting station and CPST, contact the NHTSA toll free at 1-888-327-4236 or go to <http://www.nhtsa.dot.gov>. In Canada, check with your local St. John Ambulance office for referral to a CPST or for further information, contact your provincial ministry of transportation, locate your local St. John Ambulance office by searching for St. John Ambulance on the internet, or Transport Canada at 1-800-333-0371 (<http://www.tc.gc.ca>). Failure to properly restrain children in safety seats made especially for their height, age, and weight may result in an increased risk of serious injury or death to your child.



Do not leave children or animals unattended in the vehicle. On hot days, the temperature in the trunk or vehicle interior can rise very quickly. Exposure of people or animals to these high temperatures for even a short time can cause death or serious heat-related injuries, including brain damage. Small children are particularly at risk.

Child Safety

Recommendations for Safety Restraints for Children

Child	Child size, height, weight, or age	Recommended restraint type
Infants or toddlers	Children weighing 40 lb (18 kg) or less (generally age four or younger).	Use a child safety seat (sometimes called an infant carrier, convertible seat, or toddler seat).
Small children	Children who have outgrown or no longer properly fit in a child safety seat (generally children who are less than 4 ft. 9 in. (1.45 m) tall, are greater than age four and less than age 12, and between 40 lb (18 kg) and 80 lb (36 kg) and upward to 100 lb (45 kg) if recommended by your child restraint manufacturer).	Use a belt-positioning booster seat.
Larger children	Children who have outgrown or no longer properly fit in a belt-positioning booster seat (generally children who are at least 4 ft. 9 in. (1.45 m) tall or greater than 80 lb (36 kg) or 100 lb (45 kg) if recommended by child restraint manufacturer).	Use a vehicle safety belt having the lap belt snug and low across the hips, shoulder belt centered across the shoulder and chest, and seat back upright.

- You are required by law to properly use safety seats for infants and toddlers in the United States and Canada.
- Many states and provinces require that small children use approved booster seats until they reach age eight, a height of 4 feet 9 inches (1.45 meters) tall, or 80 pounds (36 kilograms). Check your local and state or provincial laws for specific requirements about the safety of children in your vehicle.
- When possible, always properly restrain children 12 years of age and under in a rear seating position of your vehicle. Accident statistics suggest that children are safer when properly restrained in the rear seating positions than in a front seating position. See **Front Passenger Sensing System** (page 45).

INSTALLING CHILD RESTRAINTS

Child Seats



E142594

Child Safety

Use a child safety seat (sometimes called an infant carrier, convertible seat, or toddler seat) for infants, toddlers, or children weighing 40 pounds (18 kilograms) or less (generally age four or younger).

Using Lap and Shoulder Belts (Except Front Center Position of Super Cab and Crew Cab)

WARNINGS



Airbags can kill or injure a child in a child seat. Never place a rear-facing child seat in front of an active airbag.

If you must use a forward-facing child seat in the front seat, move the vehicle seat upon which the seat is installed all the way back.



Airbags can kill or injure a child in a child seat. Children 12 and under should be properly restrained in the rear seat whenever possible.



Depending on where you secure a child restraint, and depending on the child restraint design, you may block access to certain safety belt buckle assemblies and LATCH lower anchors, rendering those features potentially unusable. To avoid risk of injury, occupants should only use seating positions where they are able to be properly restrained.

When installing a child safety seat with combination lap and shoulder belts:

- Use the correct safety belt buckle for that seating position.
- Insert the belt tongue into the proper buckle until you hear a snap and feel it latch. Make sure the tongue is securely fastened in the buckle.
- Keep the buckle release button pointing up and away from the safety seat, with the tongue between the child seat and the release button, to prevent accidental unbuckling.

- Place the vehicle seat upon which the child seat will be installed in the upright position.
- Put the safety belt in the automatic locking mode. This vehicle does not require the use of a locking clip.

Perform the following steps when installing the child seat with combination lap and shoulder belts:

Note: Although the child seat illustrated is a forward facing child seat, the steps are the same for installing a rear facing child seat.



E142528

1. Position the child safety seat in a seat with a combination lap and shoulder belt.



E142529

2. Pull down on the shoulder belt and then grasp the shoulder belt and lap belt together.

Child Safety



E142530

3. While holding the shoulder and lap belt portions together, route the tongue through the child seat according to the child seat manufacturer's instructions. Be sure the belt webbing is not twisted.



E142875

5. To put the retractor in the automatic locking mode, grasp the shoulder portion of the belt and pull downward until all of the belt is pulled out.

Note: *The automatic locking mode is available on the front passenger and rear seats. This vehicle does not require the use of a locking clip.*

6. Allow the belt to retract to remove slack. The belt will click as it retracts to indicate it is in the automatic locking mode.
7. Try to pull the belt out of the retractor to make sure the retractor is in the automatic locking mode (you should not be able to pull more belt out). If the retractor is not locked, unbuckle the belt and repeat Steps 5 and 6.

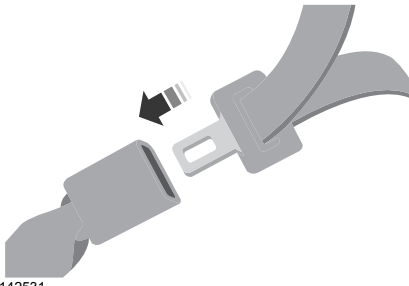

E142531

4. Insert the belt tongue into the proper buckle (the buckle closest to the direction the tongue is coming from) for that seating position until you hear a snap and feel the latch engage. Make sure the tongue is latched securely by pulling on it.



E142533

Child Safety

- Remove remaining slack from the belt. Force the seat down with extra weight, for example, by pressing down or kneeling on the child restraint while pulling up on the shoulder belt in order to force slack from the belt. This is necessary to remove the remaining slack that will exist once the extra weight of the child is added to the child restraint. It also helps to achieve the proper snugness of the child seat to your vehicle. Sometimes, a slight lean toward the buckle will help to remove remaining slack from the belt.
- Attach the tether strap (if the child seat is equipped).

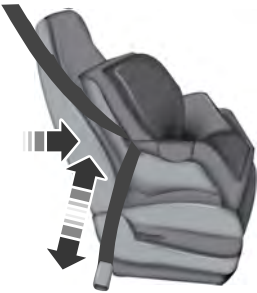

E142534



- Before placing the child in the seat, forcibly move the seat forward and back to make sure the seat is securely held in place.

To check this, grab the seat at the belt path and attempt to move it side to side and forward and back. There should be no more than 1 inch (2.5 centimeters) of movement for proper installation.

Ford recommends checking with a NHTSA Certified Child Passenger Safety Technician to make certain the child restraint is properly installed. In Canada, check with your local St. John Ambulance office for referral to a Certified Passenger Seat Technician.

Using Lap and Shoulder Belts (Front Center Position of Super Cab and Crew Cab)

WARNINGS

-  Airbags can kill or injure a child in a child seat. If you must use a forward-facing child seat in the front seat, move the vehicle seat upon which the seat is installed all the way back.
-  Rear facing child seats should never be placed in front of an active airbag.
-  Always use both lap and shoulder safety belt in the center seating position.

The belt webbing below the tongue is the lap portion of the combination lap and shoulder belt, and the belt webbing above the tongue is the shoulder belt portion of the combination lap and shoulder belt.



E142528

- Position the child safety seat in the front center seat.

Child Safety



E162708

2. Slide the tongue up the webbing.



E142530

3. While holding both shoulder and lap portions next to the tongue, route the tongue and webbing through the child seat according to the child seat manufacturer's instructions. Be sure that the belt webbing is not twisted.

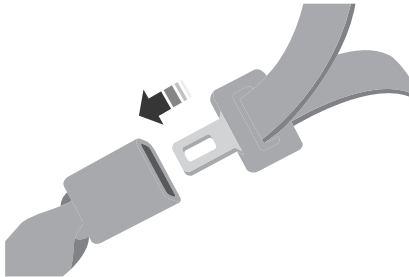

E142531

4. Insert the belt tongue into the proper buckle (the buckle closest to the direction the tongue is coming from) for that seating position until you hear a snap and feel the latch engage. Make sure the tongue is latched securely by pulling on it.



E142533

5. While pushing down with your knee on the child seat pull up on the shoulder belt portion to tighten the lap belt portion of the combination lap and shoulder belt.
6. Allow the safety belt to retract and remove any slack in the belt to securely tighten the child safety seat in the vehicle.
7. Attach the tether strap (if the child seat is equipped).



E142534

Child Safety

- Before placing the child in the seat, forcibly move the seat forward and back to make sure the seat is securely held in place. To check this, grab the seat at the belt path and attempt to move it side to side and forward and back. There should be no more than 1 inch (2.5 centimeters) of movement for proper installation.
- Check from time to time to be sure that there is no slack in the lap and shoulder belt. The shoulder belt must be snug to keep the lap belt tight during a crash.

Ford recommends checking with a NHTSA Certified Child Passenger Safety Technician to make certain the child restraint is properly installed. In Canada, check with your local St. John Ambulance office for referral to a Child Passenger Safety Technician.

Using Inflatable Safety Belts (Rear Seat Outboard Positions) (If

Equipped)



E142528

- Position the child safety seat in a seat with a combination lap and shoulder belt.



E146522

- After positioning the child safety seat in the proper seating position, grasp the shoulder belt and lap belt together behind the belt tongue.



E142530

- While holding the shoulder and lap belt portions together, route the tongue through the child seat according to the child seat manufacturer's instructions. Be sure the belt webbing is not twisted.

Child Safety

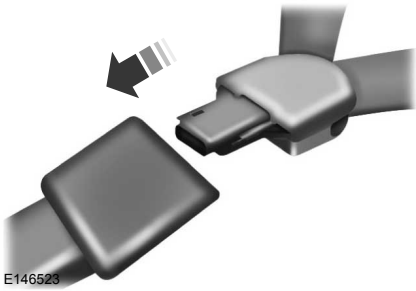

4. Insert the belt tongue into the proper buckle (the buckle closest to the direction the tongue is coming from) for that seating position until you hear a snap and feel the latch engage. Make sure the tongue is latched securely by pulling on it.

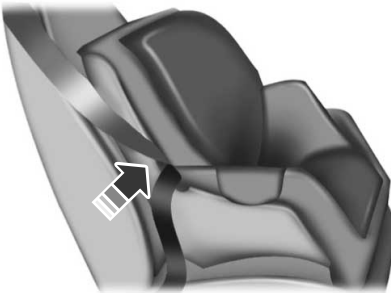

5. To put the retractor in the automatic locking mode, grasp the lap portion of the inflatable safety belt and pull upward until all of the belt is pulled out.

Note: The automatic locking mode is available on the front passenger and rear seats.

Note: Unlike the standard safety belt, the inflatable safety belt's unique lap portion locks the child seat for installation. The ability for the shoulder portion of the belt to move freely is normal, even after the lap belt has been put into the automatic locking mode.

Note: The lock-off device on some child restraints may not accommodate the shoulder portion of the inflatable safety belt. Follow all instructions provided by the manufacturer of the child restraint regarding the necessary and proper use of the lock-off device. In some instances, these devices have been provided only for use in vehicles with safety belt systems that would otherwise require a locking clip.

6. Allow the belt to retract to remove slack. The belt will click as it retracts to indicate it is in the automatic locking mode.
7. Try to pull the belt out of the retractor to make sure the retractor is in the automatic locking mode (you should not be able to pull more belt out). If the retractor is not locked, unbuckle the belt and repeat Steps 5 and 6.

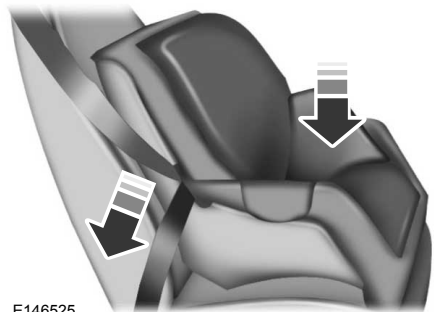

Child Safety

- Remove remaining slack from the belt. Force the seat down with extra weight, for example, by pressing down or kneeling on the child restraint while pulling down on the lap belt in order to force slack from the belt. This is necessary to remove the remaining slack that will exist once the extra weight of the child is added to the child restraint. It also helps to achieve the proper snugness of the child seat to your vehicle. Sometimes, a slight lean toward the buckle will additionally help to remove remaining slack from the belt.
- Attach the tether strap (if the child seat is equipped).

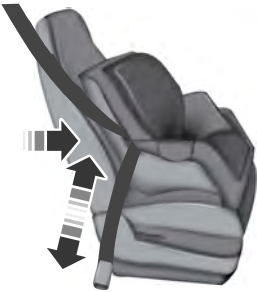

E142534

- Before placing the child in the seat, forcibly move the seat forward and back to make sure the seat is securely held in place. To check this, grab the seat at the belt path and attempt to move it side to side and forward and back. There should be no more than 1 inch (2.5 centimeters) of movement for proper installation.

Ford recommends checking with a NHTSA Certified Child Passenger Safety Technician to make certain the child restraint is properly installed. In Canada, check with your local St. John Ambulance office for referral to a Certified Passenger Seat Technician.

Using Lower Anchors and Tethers for Children (LATCH)

WARNINGS



Never attach two child safety seats to the same anchor. In a crash, one anchor may not be strong enough to hold two child safety seat attachments and may break, causing serious injury or death.



Depending on where you secure a child restraint, and depending on the child restraint design, you may block access to certain safety belt buckle assemblies or LATCH lower anchors, rendering those features potentially unusable. To avoid risk of injury, occupants should only use seating positions where they are able to be properly restrained.

The LATCH system is composed of three vehicle anchor points: two lower anchors located where the vehicle seat back and seat cushion meet (called the seat bight) and one top tether anchor located behind that seating position.

LATCH compatible child safety seats have two rigid or webbing mounted attachments that connect to the two lower anchors at the LATCH equipped seating positions in your vehicle. This type of attachment method eliminates the need to use safety belts to attach the child seat, however the safety belt can still be used to attach the child seat if the lower anchors are not used. For forward-facing child seats, the top tether strap must also be attached to the proper top tether anchor, if a top tether strap has been provided with your child seat.

Your vehicle is equipped with LATCH lower anchors for child seat installation at the following seating positions (LATCH is not available on Regular Cab):

Child Safety

Crew Cab and Super Cab

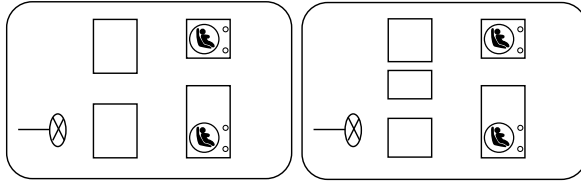

E166694



E166695

The lower LATCH anchors are located at the rear section of the rear seat between the cushion and seatback. Follow the child seat manufacturer's instructions to properly install a child seat with LATCH attachments.

Follow the instructions later in this chapter on attaching child safety seats with tether straps.

Attach LATCH lower attachments of the child seat only to the anchors shown.

Use of Inboard Lower Anchors from the Outboard Seating Positions (Center Seating Use)

WARNING



The standardized spacing for LATCH lower anchors is 11 inches (280 millimeters) center to center. Do not use LATCH lower anchors for the center seating position unless the child seat manufacturer's instructions permit and specify using anchors spaced at least as far apart as those in this vehicle.

The lower anchors at the center of the second row rear seat are spaced 25.7 inches (652 millimeters) apart. The standardized spacing for LATCH lower anchors is 11 inches (280 millimeters) center to center. A child seat with rigid LATCH attachments cannot be installed at the center seating position. LATCH compatible child seats (with attachments on belt webbing) can only be used at this seating position provided that the child seat manufacturer's instructions permit use with the anchor spacing stated. Do not attach a child seat to any lower anchor if an adjacent child seat is attached to that anchor.

Child Safety

Each time you use the safety seat, check that the seat is properly attached to the lower anchors and tether anchor, if applicable. Tug the child seat from side to side and forward and back where it is secured to the vehicle. The seat should move less than one inch when you do this for a proper installation.

If the safety seat is not anchored properly, the risk of a child being injured in a crash greatly increases.

Combining Safety Belt and LATCH Lower Anchors for Attaching Child Safety Seats

When used in combination, either the safety belt or the LATCH lower anchors may be attached first, provided a proper installation is achieved. Attach the tether strap afterward, if included with the child seat.

Using Tether Straps

Many forward-facing child safety seats include a tether strap which extends from the back of the child safety seat and hooks to an anchoring point called the top tether anchor. Tether straps are available as an accessory for many older safety seats.

Contact the manufacturer of your child seat for information about ordering a tether strap, or to obtain a longer tether strap if the tether strap on your safety seat does not reach the appropriate top tether anchor in the vehicle.

The passenger seats of your vehicle may be equipped with built-in tether strap anchors located behind the seats as described below.

The tether anchors in your vehicle may be loops of webbing above the seatback or an anchor bracket behind the seat on the rear edge of the seat cushion.

The rear seat in the Crew Cab and Super Cab has three straps along the top of the seat back that function as both routing loops for the tether straps and anchor loops.

The tether strap anchors in your vehicle are in the following positions (shown from top view):

Regular Cab

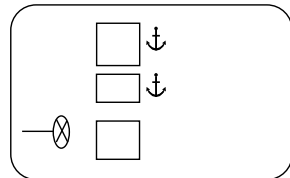

E166696

Child Safety

Crew Cab and Super Cab

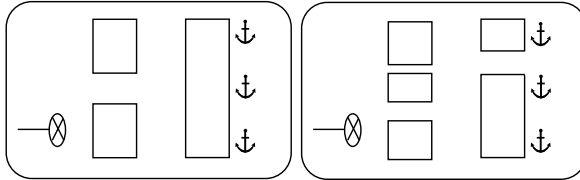

E166697

Attach the tether strap only to the appropriate tether anchor as shown. The tether strap may not work properly if attached somewhere other than the correct tether anchor.

If you install a child seat with rigid LATCH attachments, do not tighten the tether strap enough to lift the child seat off the vehicle seat cushion when the child is seated in it. Keep the tether strap just snug without lifting the front of the child seat. Keeping the child seat just touching the vehicle seat gives the best protection in a severe crash.

Once the child safety seat has been installed using either the safety belt, the lower anchors of the LATCH system, or both, you can attach the top tether strap.

Front Seat Tether Strap Attachment (Regular Cab)

1. Route the child safety seat tether strap over the back of the seat and under the head restraint.

Note: For vehicles with adjustable head restraints, route the tether strap under the head restraint and between the head restraint posts, otherwise route the tether strap over the top of the seat back.

2. Locate the correct anchor for the selected seating position. You may need to pull the seat back forward to access the tether anchors. Make sure the seat is locked in the upright position before installing the child seat.
3. Clip the tether strap to the anchor as shown.

Regular Cab passenger and center seats (located on back panel)



E175295

If the tether strap is clipped incorrectly, the child safety seat may not be retained properly in the event of a crash.

4. Tighten the child safety seat tether strap according to the manufacturer's instructions.

Child Safety

If the safety seat is not anchored properly, the risk of a child being injured in a crash greatly increases.

If your child restraint system is equipped with a tether strap, and the child restraint manufacturer recommends its use, Ford also recommends its use.

Rear Seat Tether Strap Attachment (Crew Cab and Super Cab)



E167009

There are three loops of webbing just above the back of the rear seat (along the bottom edge of the rear window). Use these loops as both routing loops and anchor loops for up to three child safety seat tether straps.

For example, the center loop can be used as a routing loop for a child safety seat in the center rear seat and as an anchoring loop for child seats installed in the outboard rear seats.

Many tether straps cannot be tightened if the tether strap is hooked to the loop directly behind the child seat. To provide a tight tether strap:

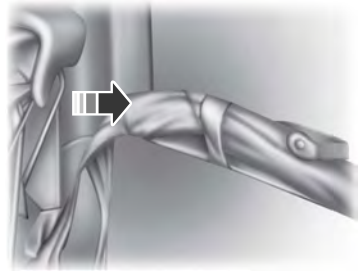

E162714

1. Route the tether strap under the head restraint and through the loop directly behind the child seat.

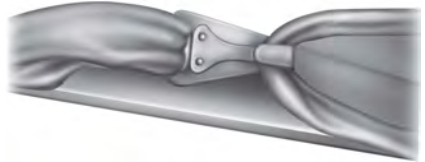

E162715

2. Route the tether strap behind the head restraint supports to a loop behind an adjacent seating position, and hook the strap onto the loop. If using the driver side, pass the strap behind the shoulder belt for the center seat. Always put the tether strap through the routing loop. The head restraint support post will hold the child seat tightly, but the head restraint post is not strong enough to hold the child seat during a crash.
3. Tighten the tether strap according to the child seat manufacturer's instructions.

Child Safety

If the safety seat is not anchored properly, the risk of a child being injured in a crash greatly increases.

If your child restraint system is equipped with a tether strap, and the child restraint manufacturer recommends its use, Ford also recommends its use.

BOOSTER SEATS

WARNING



Never place, or allow a child to place, the shoulder belt under a child's arm or behind the back because it reduces the protection for the upper part of the body and may increase the risk of injury or death in a crash.

Note: Some booster seat safety belt guides may not accommodate the shoulder portion of the inflatable safety belt.

Use a belt-positioning booster seat for children who have outgrown or no longer properly fit in a child safety seat (generally children who are less than 4 feet 9 inches (1.45 meters) tall, are greater than age four (4) and less than age twelve (12), and between 40 pounds (18 kilograms) and 80 pounds (36 kilograms) and upward to 100 pounds (45 kilograms) if recommended by your child restraint manufacturer). Many state and provincial laws require that children use approved booster seats until they reach age eight, a height of 4 feet 9 inches (1.45 meters) tall, or 80 pounds (36 kilograms).

Booster seats should be used until you can answer YES to ALL of these questions when seated without a booster seat:

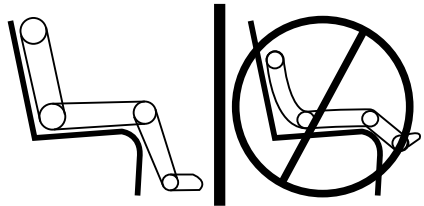

E142595

- Can the child sit all the way back against their vehicle seat back with knees bent comfortably at the edge of the seat cushion?
- Can the child sit without slouching?
- Does the lap belt rest low across the hips?
- Is the shoulder belt centered on the shoulder and chest?
- Can the child stay seated like this for the whole trip?

Always use booster seats in conjunction with your vehicle lap and shoulder belt.

Types of Booster Seats



E68924

- Backless booster seats

Child Safety

If your backless booster seat has a removable shield, remove the shield. If a vehicle seating position has a low seat back or no head restraint, a backless booster seat may place your child's head (as measured at the tops of the ears) above the top of the seat. In this case, move the backless booster to another seating position with a higher seat back or head restraint and lap and shoulder belts, or consider using a high back booster seat.



E70710

- High back booster seats

If, with a backless booster seat, you cannot find a seating position that adequately supports your child's head, a high back booster seat would be a better choice.

Children and booster seats vary in size and shape. Choose a booster that keeps the lap belt low and snug across the hips, never up across the stomach, and lets you adjust the shoulder belt to cross the chest and rest snugly near the center of the shoulder. The following drawings compare the ideal fit (center) to a shoulder belt uncomfortably close to the neck and a shoulder belt that could slip off the shoulder. The drawings also show how the lap belt should be low and snug across the child's hips.



E142596

Child Safety





E142597

If the booster seat slides on the vehicle seat upon which it is being used, placing a rubberized mesh sold as shelf or carpet liner under the booster seat may improve this condition. Do not introduce any item thicker than this under the booster seat. Check with the booster seat manufacturer's instructions.

CHILD RESTRAINT POSITIONING

WARNINGS

 Airbags can kill or injure a child in a child seat. Never place a rear-facing child seat in front of an active airbag. If you must use a forward-facing child seat in the front seat, move the vehicle seat upon which the child seat is installed all the way back. When possible, all children age 12 and under should be properly restrained in a rear seating position. If all children cannot be seated and restrained properly in a rear seating position, properly restrain the largest child in the front seat.

 Always carefully follow the instructions and warnings provided by the manufacturer of any child restraint to determine if the restraint device is appropriate for your child's size, height, weight, or age. Follow the child restraint manufacturer's instructions and warnings

WARNINGS

provided for installation and use in conjunction with the instructions and warnings provided by your vehicle manufacturer. A safety seat that is improperly installed or utilized, is inappropriate for your child's height, age, or weight or does not properly fit the child may increase the risk of serious injury or death.

 Never let a passenger hold a child on his or her lap while your vehicle is moving. The passenger cannot protect the child from injury in a crash, which may result in serious injury or death.

 Never use pillows, books, or towels to boost a child. They can slide around and increase the likelihood of injury or death in a crash.

 Always restrain an unoccupied child seat or booster seat. These objects may become projectiles in a crash or sudden stop, which may increase the risk of serious injury.

 Never place, or allow a child to place, the shoulder belt under a child's arm or behind the back because it reduces the protection for the upper part of the body and may increase the risk of injury or death in a crash.

Child Safety

WARNINGS



To avoid risk of injury, do not leave

WARNINGS

children or pets unattended in your vehicle.

Recommendations for attaching child safety restraints for children

Restraint Type	Combined weight of child and child seat	Use any attachment method as indicated below by X				
		LATCH (lower anchors and top tether anchor)	LATCH (lower anchors only)	Safety belt and top tether anchor	Safety belt and LATCH (lower anchors and top tether anchor)	Safety belt only
Rear facing child seat	Up to 65 lb (29.5 kg)		X			X
Rear facing child seat	Over 65 lb (29.5 kg)					X
Forward facing child seat	Up to 65 lb (29.5 kg)	X		X	X	
Forward facing child seat	Over 65 lb (29.5 kg)			X	X	

Note: *The child seat must rest tightly against the vehicle seat upon which it is installed. It may be necessary to lift or remove the head restraint. See **Seats** (page 139).*

CHILD SAFETY LOCKS (If Equipped)

When these locks are set, the rear doors cannot be opened from the inside.

Child Safety

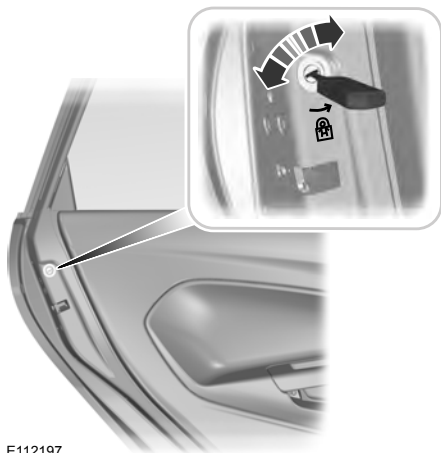

E112197

The childproof locks are located on the rear edge of each rear door and must be set separately for each door.

Left-Hand Side

Turn counterclockwise to lock and clockwise to unlock.

Right-Hand Side

Turn clockwise to lock and counterclockwise to unlock.

Seatbelts

PRINCIPLE OF OPERATION

WARNINGS



Always drive and ride with your seatback upright and the lap belt snug and low across the hips.



To reduce the risk of injury, make sure children sit where they can be properly restrained.



Never let a passenger hold a child on his or her lap while the vehicle is moving. The passenger cannot protect the child from injury in a crash, which may result in serious injury or death.



All occupants of the vehicle, including the driver, should always properly wear their safety belts, even when an airbag supplemental restraint system is provided. Failure to properly wear your safety belt could seriously increase the risk of injury or death.



It is extremely dangerous to ride in a cargo area, inside or outside of a vehicle. In a crash, people riding in these areas are more likely to be seriously injured or killed. Do not allow people to ride in any area of your vehicle that is not equipped with seats and safety belts. Be sure everyone in your vehicle is in a seat and using a safety belt properly.



In a rollover crash, an unbelted person is significantly more likely to die than a person wearing a safety belt.



Each seating position in your vehicle has a specific safety belt assembly which is made up of one buckle and one tongue that are designed to be used as a pair. 1) Use the shoulder belt on the outside shoulder only. Never wear the shoulder belt under the arm. 2) Never swing the safety belt around your neck over the inside shoulder. 3) Never use a single belt for more than one person.

WARNINGS



When possible, all children 12 years old and under should be properly restrained in a rear seating position. Failure to follow this could seriously increase the risk of injury or death.



Safety belts and seats can become hot in a vehicle that has been closed up in sunny weather; they could burn a small child. Check seat covers and buckles before you place a child anywhere near them.



Front and rear seat occupants, including pregnant women, should wear safety belts for optimum protection in an accident.

All seating positions in this vehicle have lap and shoulder safety belts. All occupants of the vehicle should always properly wear their safety belts, even when an airbag supplemental restraint system is provided.

The safety belt system consists of:

- Lap and shoulder safety belts.
- Shoulder safety belt with automatic locking mode, (except driver safety belt).
- Height adjuster at the front outboard seating positions.
- Safety belt pretensioner at the front outboard seating positions.



- Safety belt warning light and chime.



- Crash sensors and monitoring system with readiness indicator.

Seatbelts

The safety belt pretensioners at the front seating positions are designed to tighten the safety belts when activated. In frontal and near-frontal crashes, the safety belt pretensioners may be activated alone or, if the crash is of sufficient severity, together with the front airbags. In side crashes and rollovers, the pretensioners will be activated when the Safety Canopy is activated.

FASTENING THE SEATBELTS

Standard belts shown, inflatable belts similar

The front outboard and rear safety restraints in the vehicle are combination lap and shoulder belts.



E142587

1. Insert the belt tongue into the proper buckle (the buckle closest to the direction the tongue is coming from) until you hear a snap and feel it latch. Make sure you securely fasten the tongue in the buckle.

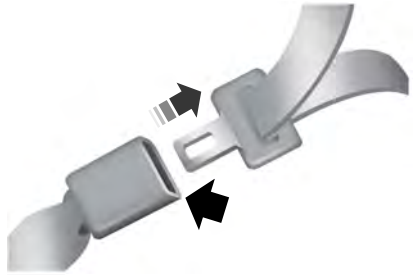

E142588

2. To unfasten, press the release button and remove the tongue from the buckle.

Using the Safety Belt with Cinch Tongue (Front Center Seat)

The cinch tongue will slide up and down the belt webbing when the belt is stowed or while putting safety belts on. When you buckle the lap and shoulder safety belt, the cinch tongue will allow you to shorten the lap portion, but pinches the webbing to keep the lap portion from getting longer. The cinch tongue is designed to slip during a crash, so always wear the shoulder belt properly and do not allow any slack in either the lap or shoulder portions.

Before you can reach and latch a lap and shoulder belt having a cinch tongue into the buckle, you may have to lengthen the lap belt portion of it.

Seatbelts



E162708

1. To lengthen the lap belt, pull some webbing out of the shoulder belt retractor.
2. While holding the webbing below the tongue, grasp the tip (metal portion) of the tongue so that it is parallel to the webbing and slide the tongue upward.
3. Provide enough lap belt length so that the tongue can reach the buckle.

Fastening the Cinch Tongue

WARNING



The lap belt should fit snugly and as low as possible around the hips, not across the waist.

1. Pull the lap and shoulder belt from the retractor so that the shoulder belt portion of the safety belt crosses your shoulder and chest.
2. Be sure the belt is not twisted. If the belt is twisted, remove the twist.
3. Insert the belt tongue into the proper buckle for your seating position until you hear a snap and feel it latch.
4. Make sure you securely fasten the tongue to the buckle by pulling on the tongue.

While you are fastened in the safety belt, the lap and shoulder belt with a cinch tongue adjusts to your movement. However, if you brake hard, turn hard, or if your vehicle receives an impact of 5 mph (8 km/h) or more, the safety belt will become locked and help reduce your forward movement.

Using Safety Belts During Pregnancy

WARNING



Always ride and drive with your seatback upright and the safety belt properly fastened. The lap portion of the safety belt should fit snug and be positioned low across the hips. The shoulder portion of the safety belt should be positioned across the chest. Pregnant women should also follow this practice.

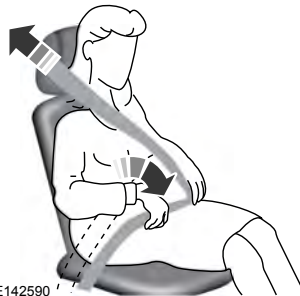

E142590

Pregnant women should always wear their safety belt. Position the lap belt portion of a combination lap and shoulder belt low across the hips below the belly and worn as tight as comfort will allow. Position the shoulder belt to cross the middle of the shoulder and the center of the chest.

Seatbelts

Safety Belt Locking Modes

WARNINGS



After any vehicle crash, the safety belt system at all passenger seating positions must be checked by an authorized dealer to verify that the automatic locking retractor feature for child seats is still functioning properly. In addition, all safety belts should be checked for proper function.



The belt and retractor must be replaced if the safety belt assembly automatic locking retractor feature or any other safety belt function is not operating properly when checked by an authorized dealer. Failure to replace the belt and retractor assembly could increase the risk of injury in crashes.

All safety restraints in the vehicle are combination lap and shoulder belts. The driver safety belt has the first type of locking mode, and the front outboard passenger and rear seat safety belts have both types of locking modes described as follows:

Vehicle Sensitive Mode

This is the normal retractor mode, which allows free shoulder belt length adjustment to your movements and locking in response to vehicle movement. For example, if the driver brakes suddenly, turns a corner sharply, or the vehicle receives an impact of about 5 mph (8 km/h) or more, the combination safety belts will lock to help reduce forward movement of the driver and passengers.

In addition, the retractor is designed to lock if the webbing is pulled out too quickly. If this occurs, let the belt retract slightly and pull webbing out again in a slow and controlled manner.

Automatic Locking Mode

In this mode, the shoulder belt is automatically pre-locked. The belt will still retract to remove any slack in the shoulder belt. The automatic locking mode is not available on the driver safety belt.

When to Use the Automatic Locking Mode

Use this mode any time you install a child safety seat in a front outboard passenger seating position in a Regular Cab, SuperCab, SuperCrew or any rear seating position of a SuperCab or SuperCrew. The optional front seat's center safety belt has a cinch mechanism. Children 12 years old and under should be properly restrained in a rear seat whenever possible. See **Child Safety** (page 15).

How to Use the Automatic Locking Mode

Non-inflatable safety belts



E142591

1. Buckle the combination lap and shoulder belt.
2. Grasp the shoulder portion and pull downward until you pull the entire belt out.
3. Allow the belt to retract. As the belt retracts, you will hear a clicking sound. This indicates the safety belt is now in the automatic locking mode.

Seatbelts

Rear outboard inflatable safety belts (second row only— if equipped)



E146363

1. Buckle the combination lap and shoulder belt.
2. Grasp the lap portion of the belt and pull upward until the entire belt is pulled out.
3. Allow the belt to retract. As the belt retracts, you will hear a clicking sound. This indicates the safety belt is now in the automatic locking mode.

How to Disengage the Automatic Locking Mode

Unbuckle the combination lap and shoulder belt and allow it to retract completely to disengage the automatic locking mode and activate the vehicle sensitive (emergency) locking mode.

Rear Inflatable Safety Belt (if Equipped)

WARNING



Do not attempt to service, repair, or modify the rear inflatable safety belt.

The rear inflatable safety belts are fitted in the shoulder portion of the safety belts of the second-row outboard seating positions.

Note: *The rear inflatable safety belts are compatible with most infant and child safety car seats and belt positioning booster seats when properly installed. This is because they are designed to fill with a cooled gas at a lower pressure and at a slower rate than traditional airbags. After inflation, the shoulder portion of the safety belt remains cool to the touch.*

The rear inflatable safety belt consists of the following:

- An inflatable bag located in the shoulder safety belt webbing.
- Lap safety belt webbing with automatic locking mode.
- The same warning light, electronic control and diagnostic unit as used for the front safety belts.
- Impact sensors located in various parts of the vehicle.

How does the rear inflatable safety belt system work?

The rear inflatable safety belts will function like standard restraints in everyday usage.



E146364

During a crash of sufficient force, the inflatable belt will inflate from inside the webbing.

Seatbelts



E146365

The fully inflated belt's increased diameter more effectively holds the occupant in the appropriate seating position, and spreads crash forces over more area of the body than regular safety belts. This helps reduce pressure on the chest and helps control head and neck motion for passengers.

WARNING



If the rear inflatable safety belt has deployed, it will not function again. The rear inflatable safety belt system must be replaced by an authorized dealer.

The rear inflatable safety belts are designed to inflate in frontal or near-frontal crashes, rollovers and some side impact crashes. The fact that the rear inflatable safety belt did not inflate in a crash does not mean that something is wrong with the system. Rather, it means the forces were not of the type sufficient to cause activation.

Safety Belt Extension Assembly

WARNINGS



Do not use extensions to change the fit of the shoulder belt across the torso.



Do not use extensions with an inflatable safety belt.

If the safety belt is too short when fully extended, you can obtain a safety belt extension assembly from an authorized dealer.

Use only extensions manufactured by the same supplier as the safety belt. Manufacturer identification is located at the end of the webbing on the label or on the retractor behind the trim. Also, use the safety belt extension only if the safety belt is too short for you when fully extended.

SEATBELT HEIGHT ADJUSTMENT

WARNING



Position the safety belt height adjuster so that the belt rests across the middle of your shoulder. Failure to adjust the safety belt properly could reduce the effectiveness of the safety belt and increase the risk of injury in a crash.

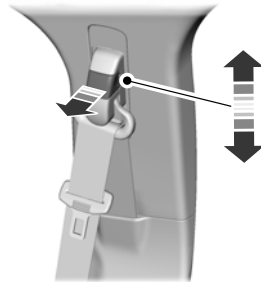

E145664

Adjust the height of the shoulder belt so the belt rests across the middle of your shoulder.

To adjust the shoulder belt height:

1. Pull the button and slide the height adjuster up or down.

Seatbelts

2. Release the button and pull down on the height adjuster to make sure it is locked in place.

SEATBELT WARNING LAMP AND INDICATOR CHIME



This lamp illuminates and an audible warning will sound if the driver's safety belt has not been fastened when the vehicle's ignition is turned on.

Conditions of operation

If...	Then...
The driver's safety belt is not buckled before the ignition switch is turned to the on position...	The safety belt warning light illuminates 1-2 minutes and the warning chime sounds 4-8 seconds.
The driver's safety belt is buckled while the indicator light is illuminated and the warning chime is sounding...	The safety belt warning light and warning chime turn off.
The driver's safety belt is buckled before the ignition switch is turned to the on position...	The safety belt warning light and indicator chime remain off.

SEATBELT REMINDER

Belt-Minder™

This feature supplements the safety belt warning function by providing additional reminders that intermittently sound a tone and illuminate the safety belt warning light when you are in the driver seat or you have a front seat passenger and a safety belt is unbuckled.

The system uses information from the front passenger sensing system to determine if a front seat passenger is present and therefore potentially in need of a warning. To avoid activating the Belt-Minder feature for objects you place in the front passenger seat, only the front seat passengers receive warnings as determined by the front passenger sensing system.

If the Belt-Minder warnings expire (warnings for about five minutes) for one passenger (driver or front passenger), the other passenger can still cause the Belt-Minder feature to turn on.

Seatbelts

If...	Then...
You and the front seat passenger buckle your safety belts before you switch the ignition on or less than 1-2 minutes elapse after you switch the ignition on...	The Belt-Minder feature will not activate.
You or the front seat passenger do not buckle your safety belts before your vehicle reaches at least 6 mph (9.7 km/h) and 1-2 minutes elapse after you switch the ignition on...	The Belt-Minder feature activates, the safety belt warning light illuminates and a warning tone sounds for 6 seconds every 25 seconds, repeating for about 5 minutes or until you and the front seat passenger buckle your safety belts.
The safety belt for the driver or front passenger is unbuckled for about 1 minute while the vehicle is traveling at least 6 mph (9.7 km/h) and more than 1-2 minutes elapse after you switch the ignition on...	The Belt-Minder feature activates, the safety belt warning light illuminates and a warning tone sounds for 6 seconds every 25 seconds, repeating for about 5 minutes or until you and the front seat passenger buckle your safety belts.

Deactivating and Activating the Belt-Minder Feature

WARNING



While the system allows you to deactivate it, this system is designed to improve your chances of being safely belted and surviving an accident. We recommend you leave the system activated for yourself and others who may use the vehicle.

Note: *The driver and front passenger warnings switch on and off independently. When you perform this procedure for one seating position, do not buckle the other position as this will terminate the process.*

Note: *If you are using MyKey, you cannot disable the Belt-Minder. Also, if the Belt-Minder has been previously disabled, it will be re-enabled during the use of MyKey. See **MyKey™** (page 57).*

Read Steps 1 - 4 thoroughly before proceeding with the programming procedure.

Before following the procedure, make sure that:

- The parking brake is set.
 - The transmission is in park (P).
 - The ignition is off.
 - The driver and front passenger safety belt is unbuckled.
1. Switch the ignition on. Do not start the engine.
 2. Wait until the safety belt warning light turns off (about one minute). After Step 2, wait an additional 5 seconds before proceeding with Step 3. Once you start Step 3, you must complete the procedure within 30 seconds.

Seatbelts

3. For the seating position you are switching off, buckle then unbuckle the safety belt three times at a moderate speed, ending in the unbuckled state. After Step 3, the safety belt warning light turns on.
4. While the safety belt warning light is on, buckle then unbuckle the safety belt. After Step 4, the safety belt warning light flashes for confirmation.
 - This will switch the feature off for that seating position if it is currently on.
 - This will switch the feature on for that seating position if it is currently off.

Ford Motor Company recommends that all safety belt assemblies in use in vehicles involved in a crash be replaced. However, if the crash was minor and an authorized dealer finds that the belts do not show damage and continue to operate properly, they do not need to be replaced. Safety belt assemblies not in use during a crash should also be inspected and replaced if either damage or improper operation is noted.

Properly care for safety belts. See **Vehicle Care** (page 321).

CHILD RESTRAINT AND SEATBELT MAINTENANCE

Inspect the vehicle safety belts and child safety seat systems periodically to make sure they work properly and are not damaged. Inspect the vehicle and child seat safety belts to make sure there are no nicks, tears or cuts. Replace if necessary. All vehicle safety belt assemblies, including retractors, buckles, front safety belt buckle assemblies, buckle support assemblies (slide bar-if equipped), shoulder belt height adjusters (if equipped), shoulder belt guide on seat back (if equipped), child safety seat LATCH and tether anchors, and attaching hardware, should be inspected after a crash. Read the child restraint manufacturer's instructions for additional inspection and maintenance information specific to the child restraint.

Personal Safety System™

The Personal Safety System provides an improved overall level of frontal crash protection to front seat occupants and is designed to help further reduce the risk of airbag-related injuries. The system is able to analyze different occupant conditions and crash severity before activating the appropriate safety devices to help better protect a range of occupants in a variety of frontal crash situations.

The Vehicle Personal Safety System consists of:

- Driver and passenger dual-stage airbag supplemental restraints.
- Front seat outboard safety belts with pretensioners, energy management retractors and safety belt usage sensors.
- Driver seat position sensor.
- Front passenger sensing system.
- Passenger airbag off and on indicator lamp.
- Front crash severity sensors.
- Restraints control module with impact and safing sensors.
- Restraint system warning light and backup tone.
- The electrical wiring for the airbags, crash sensors, safety belt pretensioners, front safety belt usage sensors, driver seat position sensor, front passenger sensing system and indicator lights.

How Does the Personal Safety System Work?

The Personal Safety System can adapt the deployment strategy of the safety devices according to crash severity and occupant conditions. A collection of crash and occupant sensors provides information to the restraints control module. During a crash, the restraints control module may deploy the safety belt pretensioners, one or both stages of the dual-stage airbags based on crash severity and occupant conditions.

Supplementary Restraints System

PRINCIPLE OF OPERATION

WARNINGS

 Airbags do not inflate slowly or gently, and the risk of injury from a deploying airbag is the greatest close to the trim covering the airbag module.

 All occupants of your vehicle, including the driver, should always properly wear their safety belts, even when an airbag supplemental restraint system is provided. Failure to properly wear your safety belt could seriously increase the risk of injury or death.

 Always transport children 12 years old and under in the back seat and always properly use appropriate child restraints. Failure to follow this could seriously increase the risk of injury or death.

 Never place your arm over the airbag module as a deploying airbag can result in serious arm fractures or other injuries.

 Airbags can kill or injure a child in a child seat. Never place a rear-facing child seat in front of an active airbag. If you must use a forward-facing child seat in the front seat, move the seat upon which the child seat is installed all the way back.

 Do not attempt to service, repair, or modify the airbag supplemental restraint systems or its fuses as you could be seriously injured or killed. Contact your authorized dealer as soon as possible.

 Several airbag system components get hot after inflation. To avoid risk of injury, do not touch them after inflation.

 If the airbag has deployed, the airbag will not function again and must be replaced immediately. If the airbag is not replaced, the unrepaired area will increase the risk of injury in a crash.

The airbags are a supplemental restraint system and are designed to work with the safety belts to help protect the driver and right front passenger from certain upper body injuries. Airbags do not inflate slowly; there is a risk of injury from a deploying airbag.

Note: *You will hear a loud bang and see a cloud of harmless powdery residue if an airbag deploys. This is normal.*

The airbags inflate and deflate rapidly upon activation. After airbag deployment, it is normal to notice a smoke-like, powdery residue or smell the burnt propellant. This may consist of cornstarch, talcum powder (to lubricate the bag) or sodium compounds (for example, baking soda) that result from the combustion process that inflates the airbag. Small amounts of sodium hydroxide may be present which may irritate the skin and eyes, but none of the residue is toxic.

While the system is designed to help reduce serious injuries, contact with a deploying airbag may also cause abrasions or swelling. Temporary hearing loss is also a possibility as a result of the noise associated with a deploying airbag. Because airbags must inflate rapidly and with considerable force, there is the risk of death or serious injuries such as fractures, facial and eye injuries or internal injuries, particularly to occupants who are not properly restrained or are otherwise out of position at the time of airbag deployment. Thus, it is extremely important that occupants be properly restrained as far away from the airbag module as possible while maintaining vehicle control.

Routine maintenance of the airbags is not required.

Supplementary Restraints System

DRIVER AND PASSENGER AIRBAGS

WARNINGS



Never place your arm or any objects over an airbag module. Placing your arm over a deploying airbag can result in serious arm fractures or other injuries. Objects placed on or over the airbag inflation area may cause those objects to be propelled by the airbag into your face and torso causing serious injury.



Airbags can kill or injure a child in a child seat. Never place a rear-facing child seat in front of an active airbag. If you must use a forward-facing child seat in the front seat, move the vehicle seat upon which the child seat is installed all the way back.

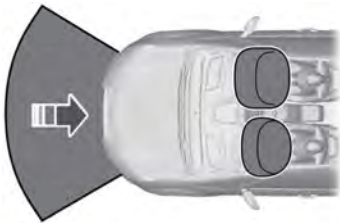

E151127

The driver and front passenger airbags will deploy during significant frontal and near frontal crashes.

The driver and passenger front airbag system consists of:

- driver and passenger airbag modules.
- front passenger sensing system.



• crash sensors and monitoring system with readiness indicator. See **Crash Sensors and Airbag Indicator** (page 49).

Indicator (page 49).

Proper Driver and Front Passenger Seating Adjustment

WARNING



The National Highway Traffic Safety Administration recommends a minimum distance of at least 10 inches (25 centimeters) between an occupant's chest and the driver airbag module.

To properly position yourself away from the airbag:

- Move your seat to the rear as far as you can while still reaching the pedals comfortably.
- Recline the seat slightly (one or two degrees) from the upright position.

After all occupants have adjusted their seats and put on safety belts, it is very important that they continue to sit properly. Properly seated occupants sit upright, lean against the seat back, and center themselves on the seat cushion, with their feet comfortably extended on the floor. Sitting improperly can increase the chance of injury in a crash event. For example, if an occupant slouches, lies down, turns sideways, sits forward, leans forward or sideways, or puts one or both feet up, the chance of injury during a crash is greatly increased.

Children and Airbags

WARNING



Airbags can kill or injure a child in a child seat. Never place a rear-facing child seat in front of an active airbag. If you must use a forward-facing child seat in the front seat, move the seat all the way back.

Supplementary Restraints System



E142846

Children must always be properly restrained. Accident statistics suggest that children are safer when properly restrained in the rear seating positions than in the front seating position. Failure to follow these instructions may increase the risk of injury in a crash.

If two adults and a child occupy a Regular Cab, properly restrain the child in the center front unless doing so would interfere with driving your vehicle. This provides lap and shoulder belt protection for all occupants, and airbag protection for the adults. A child or infant properly restrained in the center front seat should not incur risk of serious injury from the airbags.

FRONT PASSENGER SENSING SYSTEM

WARNINGS



Even with Advanced Restraints Systems, children 12 and under should be properly restrained in a rear seating position. Failure to follow this could seriously increase the risk of injury or death.

WARNINGS



Sitting improperly out of position or with the seatback reclined too far can take off weight from the seat cushion and affect the decision of the front passenger sensing system, resulting in serious injury or death in a crash. Always sit upright against your seatback, with your feet on the floor.



Any alteration or modification to the front passenger seat may affect the performance of the front passenger sensing system which could seriously increase the risk of injury or death.

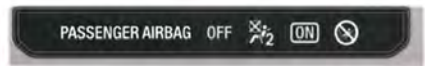

E181984

The front passenger sensing system uses a passenger airbag status indicator which will illuminate indicating that the front passenger frontal airbag is either ON (enabled) or OFF (disabled). The indicator lamp is located in the center stack of the instrument panel.

Note: *When the ignition is first turned on, the passenger airbag status indicator OFF and ON lamps will illuminate for a short period to confirm it is functional.*

The front passenger sensing system is designed to disable (will not inflate) the front passenger frontal airbag under certain conditions:

- The front passenger seat is unoccupied.
- The system determines an infant is present in a child restraint.

Supplementary Restraints System

- A passenger takes their weight off of the seat for a period of time.
- If there is a problem with the airbag system or the passenger sensing system.

Even with this technology, parents are **strongly** encouraged to always properly restrain children in the rear seat.

- When the front passenger sensing system disables (will not inflate) the front passenger frontal airbag, the passenger airbag status indicator will illuminate the OFF lamp and stay lit to remind you that the front passenger frontal airbag is disabled.
- If the child restraint has been installed and the passenger airbag status indicator illuminates the ON lamp, then turn your vehicle off, remove the child restraint from your vehicle and reinstall the restraint following the child restraint manufacturer's instructions.

The front passenger sensing system works with sensors that are part of the front passenger seat and safety belt. The sensors are designed to detect the presence of a properly seated occupant and determine if the front passenger frontal airbag should be enabled.

- When the front passenger sensing system enables the front passenger frontal airbag (may inflate), the passenger airbag status indicator will illuminate the ON lamp and remain illuminated.

If a person of adult size is sitting in the front passenger seat, but the passenger airbag status indicator OFF lamp is lit, it is possible that the person is not sitting properly in the seat. If this happens:

- Turn your vehicle off and ask the person to place the seatback in the full upright position.
- Have the person sit upright in the seat, centered on the seat cushion, with the person's legs comfortably extended.
- Restart your vehicle and have the person remain in this position for about two minutes. This will allow the system to detect that person and enable the passenger's frontal airbag.
- If the indicator OFF lamp remains lit even after this, you should advise the person to ride in the rear seat.

Note: *When the passenger airbag status indicator OFF lamp is illuminated, the passenger side airbag (seat mounted) may be disabled to avoid the risk of airbag deployment issues.*

After all occupants have adjusted their seats and put on safety belts, it is very important that they continue to sit properly. A properly seated occupant sits upright, leaning against the seatback, and centered on the seat cushion, with their feet comfortably extended on the floor. Sitting improperly can increase the chance of injury in a crash event. For example, if an occupant slouches, lies down, turns sideways, sits forward, leans forward or sideways, or puts one or both feet up, the chance of injury during a crash is greatly increased.

If you think that the state of the passenger airbag status indicator lamp is incorrect, check for the following:

- Objects lodged underneath the seat.
- Objects between the seat cushion and the center console.

Supplementary Restraints System

- Objects hanging off the seatback.
- Objects stowed in the seatback map pocket.
- Objects placed on the occupant's lap.
- Cargo interference with the seat
- Other passengers pushing or pulling on the seat.
- Rear passenger feet and knees resting or pushing on the seat.

The conditions listed above may cause the weight of a properly seated occupant to be incorrectly interpreted by the front passenger sensing system. The person in the front passenger seat may appear heavier or lighter due to the conditions described in the previous list.



Make sure the front passenger sensing system is operating properly. See **Crash Sensors and Airbag Indicator** (page 49).

If the airbag readiness light is lit, do the following:

The driver and adult passengers should check for objects lodged underneath the front passenger seat or cargo interfering with the seat.

If objects are lodged or cargo is interfering with the seat, please take the following steps to remove the obstruction:

- Pull your vehicle over.
- Turn your vehicle off.
- Driver or adult passengers should check for any objects lodged underneath the front passenger seat or cargo interfering with the seat.
- Remove the obstruction(s) (if found).
- Restart your vehicle.

- Wait at least two minutes and verify that the airbag readiness light in the instrument cluster is no longer illuminated.
- If the airbag readiness light in the instrument cluster remains illuminated, this may or may not be a problem due to the front passenger sensing system.

Do not attempt to repair or service the system. Take your vehicle immediately to an authorized dealer.

If it is necessary to modify an advanced front airbag system to accommodate a person with disabilities, contact the Ford Customer Relationship Center.

SIDE AIRBAGS

WARNINGS



Do not place objects or mount equipment on or near the airbag cover, on the side of the seatbacks (of the front seats), or in front seat areas that may come into contact with a deploying airbag. Failure to follow these instructions may increase the risk of personal injury in the event of a crash.



Do not use accessory seat covers. The use of accessory seat covers may prevent the deployment of the side airbags and increase the risk of injury in an accident.



Do not lean your head on the door. The side airbag could injure you as it deploys from the side of the seatback.



Do not attempt to service, repair, or modify the airbag, its fuses or the seat cover on a seat containing an airbag as you could be seriously injured or killed. Contact your authorized dealer as soon as possible.

Supplementary Restraints System

WARNINGS



If the side airbag has deployed, the airbag will not function again. The side airbag system (including the seat) must be inspected and serviced by an authorized dealer. If the airbag is not replaced, the unrepaired area will increase the risk of injury in a crash.

The side airbags are located on the outboard side of the seatbacks of the front seats. In certain sideways crashes, the airbag must be inspected and serviced by an authorized dealer. If the airbag is not replaced, the unrepaired area will increase the risk of injury in a crash.



E152533

The system consists of the following:

- A label or embossed side panel indicating that side airbags are fitted to your vehicle.
- Side airbags located inside the driver and front passenger seatbacks.
- Front passenger sensing system.



- Crash sensors and monitoring system with readiness indicator. See **Crash Sensors and Airbag Indicator** (page 49).

Note: *The passenger sensing system will deactivate the passenger seat-mounted side airbag if it detects an empty passenger seat.*

The design and development of the side airbag system included recommended testing procedures that were developed by a group of automotive safety experts known as the Side Airbag Technical Working Group. These recommended testing procedures help reduce the risk of injuries related to the deployment of side airbags.

SAFETY CANOPY™

WARNINGS



Do not place objects or mount equipment on or near the headliner at the siderail that may come into contact with a deploying curtain airbag. Failure to follow these instructions may increase the risk of personal injury in the event of a crash.



Do not lean your head on the door. The curtain airbag could injure you as it deploys from the headliner.



Do not attempt to service, repair, or modify the curtain airbags, its fuses, the A, B, or C pillar trim, or the headliner on a vehicle containing curtain airbags as you could be seriously injured or killed. Contact your authorized dealer as soon as possible.



All occupants of your vehicle including the driver should always wear their safety belts even when an airbag supplemental restraint system and curtain airbag is provided. Failure to properly wear your safety belt could seriously increase the risk of injury or death.



To reduce risk of injury, do not obstruct or place objects in the deployment path of the curtain airbag.

Supplementary Restraints System

WARNINGS



If the curtain airbags have deployed, the curtain airbags will not function again. The curtain airbags (including the A, B and C pillar trim and headliner) must be inspected and serviced by an authorized dealer. If the curtain airbag is not replaced, the unrepaired area will increase the risk of injury in a crash.

The Safety Canopy will deploy during significant side crashes or when a certain likelihood of a rollover event is detected by the rollover sensor. The Safety Canopy is mounted to the roof side-rail sheet metal, behind the headliner, above each row of seats. In certain sideways crashes or rollover events, the Safety Canopy will be activated, regardless of which seats are occupied. The Safety Canopy is designed to inflate between the side window area and occupants to further enhance protection provided in side impact crashes and rollover events.

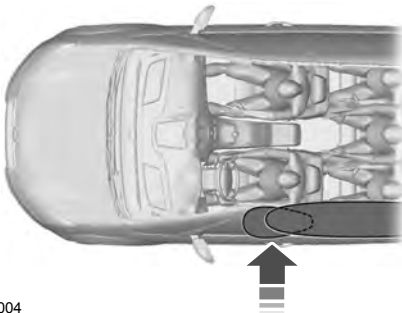

E75004

The system consists of the following:

- Safety canopy curtain airbags located above the trim panels over the front and rear side windows identified by a label or wording on the headliner or roof-pillar trim.
- A flexible headliner which opens above the side doors to allow air curtain deployment



• Crash sensors and monitoring system with a readiness indicator. See **Crash Sensors and Airbag Indicator** (page 49).

Children 12 years old and under should always be properly restrained in the rear seats. The Safety Canopy will not interfere with children restrained using a properly installed child or booster seat because it is designed to inflate downward from the headliner above the doors along the side window opening.

The design and development of the Safety Canopy included recommended testing procedures that were developed by a group of automotive safety experts known as the Side Airbag Technical Working Group. These recommended testing procedures help reduce the risk of injuries related to the deployment of side airbags (including the Safety Canopy).

CRASH SENSORS AND AIRBAG INDICATOR

WARNING



Modifying or adding equipment to the front end of the vehicle (including frame, bumper, front end body structure and tow hooks) may affect the performance of the airbag system, increasing the risk of injury. Do not modify the front end of the vehicle.

Supplementary Restraints System

Your vehicle has a collection of crash and occupant sensors which provide information to the restraints control module which deploys (activates) the front safety belt pretensioners, optional rear inflatable safety belts, driver airbag, passenger airbag, seat mounted side airbags, and the Safety Canopy®. Based on the type of crash (frontal impact, side impact or rollover), the restraints control module will deploy the appropriate safety devices.

The restraints control module also monitors the readiness of the above safety devices plus the crash and occupant sensors. The readiness of the safety system is indicated by a warning indicator light in the instrument cluster or by a backup tone if the warning light is not working. See **Instrument Cluster** (page 95). Routine maintenance of the airbag is not required.

A difficulty with the system is indicated by one or more of the following:



The readiness light will not illuminate immediately after the ignition is turned on.

- The readiness light will either flash or stay lit.
- A series of five beeps will be heard. The tone pattern will repeat periodically until the problem, the light or both are repaired.

If any of these things happen, even intermittently, have the supplemental restraint system serviced at an authorized dealer immediately. Unless serviced, the system may not function properly in the event of a crash.

The fact that the safety belt pretensioners or front airbags did not activate for both front seat occupants in a crash does not mean that something is wrong with the system. Rather, it means the restraints control module determined the accident conditions (crash severity, belt usage) were not appropriate to activate these safety devices.

- The design of the front airbags is to activate only in frontal and near-frontal crashes (not rollovers, side impacts or rear impacts unless the crash causes sufficient frontal deceleration).
- The design of the safety belt pretensioners and optional rear inflatable safety belts is to activate in frontal, near-frontal and side crashes, and in rollovers.
- The design of the side airbags is to inflate in certain side impact crashes. Side airbags may activate in other types of crashes if the vehicle experiences sufficient sideways motion or deformation.
- The design of the Safety Canopy is to inflate in certain side impact crashes or rollover events. The Safety Canopy may activate in other types of crashes if the vehicle experiences sufficient sideways motion or deformation, or a certain likelihood of rollover.

AIRBAG DISPOSAL

Contact your authorized dealer as soon as possible. Airbags must be disposed of by qualified personnel.

Keys and Remote Controls

GENERAL INFORMATION ON RADIO FREQUENCIES

This device complies with Part 15 of the FCC Rules and with Industry Canada license-exempt RSS standard(s). Operation is subject to the following two conditions: (1) This device may not cause harmful interference, and (2) This device must accept any interference received, including interference that may cause undesired operation.

Note: *Changes or modifications not expressly approved by the party responsible for compliance could void the user's authority to operate the equipment. The term **IC** before the radio certification number only signifies that Industry Canada technical specifications were met.*

The typical operating range for your transmitter is approximately 33 feet (10 meters). Vehicles with the remote start feature will have a greater range. One of the following could cause a decrease in operating range:

- weather conditions
- nearby radio towers
- structures around the vehicle
- other vehicles parked next to your vehicle

Other short-distance radio transmitters, such as amateur radios, medical equipment, wireless headphones, remote controls and alarm systems may operate on the same frequency as your remote control. If other transmitters are operating on those frequencies, you may not be able to use your remote control. Using your remote control near some types of electronic equipment, such as USB devices,

computers or cell phones can interfere with remote operation. Operating your remote control near metal or metallic-finished purses, bags or clothing can interfere with remote operation. You can lock and unlock the doors with the key.

Note: *Make sure to lock your vehicle before leaving it unattended.*

Note: *If you are in range, the remote control will operate if you press any button unintentionally.*

Intelligent Access

The system uses a radio frequency signal to communicate with your vehicle and authorize your vehicle to unlock when one of the following conditions are met:

- You touch the inside of the front exterior door handle.
- You press the tailgate release button.
- You press a button on the transmitter.

If excessive radio frequency interference is present in the area or if the transmitter battery is low, you may need to mechanically unlock your door. You can use the mechanical key blade in your intelligent access key to open the driver door in this situation. See **Remote Control** (page 51).

REMOTE CONTROL

Integrated Keyhead Transmitters (If Equipped)

Use the key blade to start your vehicle and unlock or lock the driver door from outside your vehicle. The transmitter portion functions as the remote control.

Keys and Remote Controls



E191532

Press the button to release the key. Press and hold the button to fold the key back in when not in use.



E151795

Note: Your vehicle's keys came with a security tag that provides important vehicle key cut information. Keep the tag in a safe place for future reference.

Intelligent Access Key (If Equipped)



E191531

Your intelligent access keys operate the power locks and the remote start system. The key must be in your vehicle to activate the push-button start system.

Removable Key Blade

The intelligent access key also contains a removable mechanical key blade that you can use to unlock the driver door.

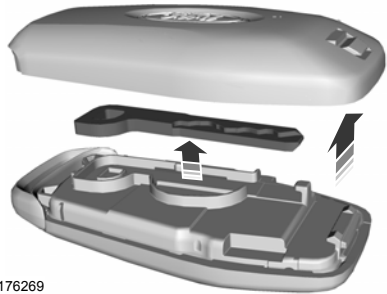

E176269

Slide the release on the back of the remote control and pivot the cover off to access the key blade.



E151795

Note: Your vehicle's backup keys came with a security tag that provides important vehicle key cut information. Keep the tag in a safe place for future reference.

Replacing the Battery

Note: Refer to local regulations when disposing of transmitter batteries.

Keys and Remote Controls

Note: Do not wipe off any grease on the battery terminals or on the back surface of the circuit board.

Note: Replacing the battery does not delete the transmitter from the vehicle. The transmitter should operate normally.

A message appears in the information display when the remote control battery is low. See **General Information** (page 103).

Integrated Keyhead Transmitter

The remote control uses one coin-type three-volt lithium battery CR2032 or equivalent.

Press the button to release the key before beginning the procedure.



1. Insert a screwdriver in the position shown and gently push the clip.
2. Press the clip down to release the battery cover.

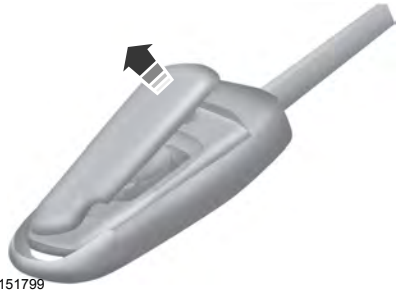

3. Carefully remove the cover.



Note: Do not touch the battery contacts or the printed circuit board with the screwdriver.

4. Insert a screwdriver as shown to release the battery.

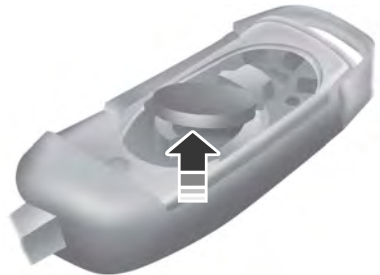

5. Remove the battery.

Keys and Remote Controls

6. Install a new battery with the + facing up.
7. Replace the battery cover.

Intelligent Access Transmitter

The remote control uses two coin-type three-volt lithium batteries CR2025 or equivalent.



E151796

1. Slide the release on the back of the remote control and pivot the cover off.



E153890

2. Insert a coin into the slot and twist to separate the housing.

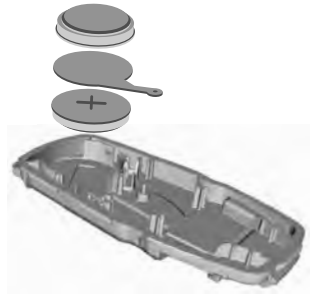

E176226

3. Remove the batteries.
4. Install new batteries with the + facing each other.

Note: Make sure to replace the label between the two batteries.

5. Reinstall the housing and cover.

Memory Feature (If Equipped)

You can use the remote control to recall memory settings for the driver seat, power mirrors, steering column and power foot pedals.

Press the unlock button on a linked remote control to recall the memory positions. If you enable the easy-entry-and-exit feature, the seat moves to the easy-entry position. The seat moves to the driver memory position when you put the key in the ignition.

Linking a Preset Position to your Remote Control or Intelligent Access Key Fob

See **Memory Function** (page 144).

Keys and Remote Controls

Car Finder



Press the button twice within three seconds. The horn sounds and the direction indicators flash. We recommend you use this method to locate your vehicle, rather than using the panic alarm.

Sounding a Panic Alarm

Note: *The panic alarm only operates when the ignition is off.*



Press the button to activate the alarm. Press the button again or switch the ignition on to deactivate.

Remote Start (If Equipped)

WARNING



To avoid exhaust fumes, do not use remote start if your vehicle is parked indoors or areas that are not well ventilated.

Note: *Do not use remote start if your vehicle is low on fuel.*



The remote start button is on the transmitter.

This feature allows you to start your vehicle from outside the vehicle. The transmitter has an extended operating range.

You can configure vehicles with automatic climate control to turn on the automatic climate control when you remote start your vehicle. See **Automatic Climate Control** (page 133). A manual climate control system runs at the setting you set it to when you switched off the vehicle.

Many states and provinces restrict the use of remote start. Check your local and state or provincial laws for specific requirements regarding remote start systems.

The remote start system does not work if:

- The ignition is on.
- The alarm system triggers.
- You disable the feature.
- The hood is open.
- The transmission is not in **P**.
- The vehicle battery voltage is too low.
- The service engine soon light is on.

Remote Control Feedback

An LED on the remote control provides status feedback of remote start or stop commands.

LED	Status
Solid green	Remote start or extension successful
Solid red	Remote stop successful; vehicle off
Blinking red	Remote start or stop failed
Blinking green	Waiting for status update

Remote Starting the Vehicle

Note: *You must press each button within three seconds of each other. Your vehicle remote starts only if you follow this sequence.*

Keys and Remote Controls

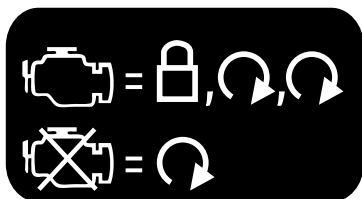

E138626

The tag with your transmitter details the starting procedure.

To remote start your vehicle:

1. Press the lock button.
2. Press the remote start button twice.
The exterior lamps flash twice.

The horn sounds if the system fails to start, unless quiet start is on. Quiet start runs the blower fan at a slower speed to reduce noise. You can switch it on or off in the information display. See **General Information** (page 103).

Note: *If you have remote started your vehicle with an integrated keyhead transmitter, you must switch on the ignition before driving your vehicle. With an intelligent access transmitter, you must press the brake pedal before driving your vehicle.*

The power windows do not work during the remote start and the radio does not turn on automatically.

The parking lamps remain on and the vehicle runs for 5, 10 or 15 minutes depending on the setting.

Extending the Vehicle Run Time

Repeat Steps 1 and 2 with the vehicle still running to extend the run time for another remote start period. If you programmed the periods to last 10 minutes, the second 10 minutes begins after what is left of the first activation time. For example, if the vehicle has run from the first remote start for five minutes, the vehicle continues to run now for a total of 20 minutes. You can extend the remote start up to a maximum of 35 minutes.

Wait at least five seconds before remote starting after a vehicle shutdown.

Turning the Vehicle Off After Remote Starting



Press the button once. The parking lamps turn off.

You may have to be closer to the vehicle than when starting due to ground reflection and the added noise of the running vehicle.

You can disable or enable the remote start system through the information display. See **General Information** (page 103).

REPLACING A LOST KEY OR REMOTE CONTROL

Replacement keys or remote controls can be purchased from an authorized dealer. Authorized dealers can program remote controls for your vehicle. See **Passive Anti-Theft System** (page 67).

PRINCIPLE OF OPERATION

MyKey allows you to program keys with restricted driving modes to promote good driving habits. All but one of the keys programmed to the vehicle can be activated with these restricted modes.

Any keys that have not been programmed are referred to as administrator keys or admin keys. They can be used to:

- Create a MyKey.
- Program configurable MyKey settings.
- Clear all MyKey features.

When you have programmed a MyKey, you can access the following information using the information display:

- How many admin keys and MyKeys are programmed to your vehicle.
- The total distance your vehicle has traveled using a MyKey.

Note: All MyKeys are programmed to the same settings. You cannot program them individually.

Note: For vehicles equipped with a push-button start switch: When both a MyKey and an admin key are present when you start your vehicle, the system recognizes the admin key only.

Non-configurable Settings

The following settings cannot be changed by an admin key user:

- Belt-Minder or safety belt reminder. You cannot disable this feature. The audio system will mute when the front seat occupants' safety belts are not fastened.
- Early low fuel. The low fuel warning is activated earlier, giving the MyKey user more time to refuel.

- Driver assist features, if equipped on your vehicle, are forced on: parking aid, blind spot information system (BLIS), cross traffic alert, lane departure warning and forward collision warning system.
- Satellite radio adult content restrictions (available only in some markets).

Configurable Settings

With an admin key, you can configure certain MyKey settings when you first create a MyKey and before you recycle the key or restart the vehicle. You can also change the settings afterward with an admin key:

- A vehicle speed limit can be set. Warnings will be shown in the display, followed by an audible tone when your vehicle reaches the set speed. You cannot override the set speed by fully depressing the accelerator pedal or by setting cruise control.

WARNING



Do not set MyKey maximum speed limit to a limit that will prevent the driver from maintaining a safe speed considering posted speed limits and prevailing road conditions. The driver is always responsible to drive in accordance with local laws and prevailing conditions. Failure to do so could result in accident or injury.

- Various vehicle speed minders can be set. Once you select a speed, it will be shown in the display, followed by an audible tone when the preselected vehicle speed is exceeded.
- Audio system maximum volume of 45%. A message will be shown in the display when you attempt to exceed the limited volume. Also, the speed-sensitive or compensated automatic volume control will be disabled.
- Always on setting. When this is selected, you will not be able to turn off Advance Trac or traction control, 911 Assist or Emergency Assistance, or Do Not Disturb (if your vehicle is equipped with these features).

CREATING A MYKEY

Use the information display to create a MyKey.

To create a MyKey:

1. Place your key into the ignition or, if your vehicle is equipped with keyless start, place your transmitter into the backup position. Details on the backup position's location are in another chapter. See **Starting a Gasoline Engine** (page 159).
2. Switch the ignition on.
3. Access the main menu using your left-hand-side steering wheel controls.
4. Depending on your display options, select either **Settings** or **Advanced Settings**, then **MyKey** and finally **Create MyKey**.
5. When the menu reads **Hold OK to Create MyKey**, press and hold the **OK** button to program a MyKey.
6. The display then prompts you to program the Configurable settings.

You can program the configurable features now or at any time. You can advance through the settings without programming them by pressing the **OK** button. MyKey then keeps all of the default settings.

When you finish programming your MyKey, the Type 3 information display adds a confirmation screen, **New MyKey Has Been Created**.

Programming/Changing Configurable Settings

Use the information display to program or change your configurable MyKey settings.

1. Place your admin key into the ignition or, if your vehicle is equipped with keyless start, place your admin transmitter into the backup position. Details on the backup position's location are in another chapter. See **Starting a Gasoline Engine** (page 159).
2. Depending on your display options, select either **Settings** or **Advanced Settings**, then **MyKey** and finally to various configurable features.
3. Scroll down through the choices, and then highlight the feature you want to configure.

Note: *You can clear or change your MyKey settings at any time during the same key cycle as you created the MyKey. Once you have switched the engine off, however, you will need an admin key to change or clear your MyKey settings.*

CLEARING ALL MYKEYS

You can clear all MyKeys within the same key cycle as you created the MyKey. If you switch your ignition off, however, you will need to use an admin key to clear your MyKeys.

Note: When you clear your MyKeys, you remove all restrictions and return all MyKeys to their original admin key status at once.

To clear all MyKeys of all MyKey settings, use the information display and the left-hand-side steering wheel controls:

1. Access the main menu and select **Settings**, then **MyKey** and finally **Clear MyKeys**.
2. Press and hold **OK**.
3. When you finish clearing all MyKeys, the Type 3 information display adds a confirmation screen, **MyKey Cleared**.

CHECKING MYKEY SYSTEM STATUS

You can find information on all programmed MyKey(s) using the information display control on the steering wheel. See **Information Displays** (page 103).

To find information on programmed MyKey(s), press the left arrow button to access the main menu and scroll to:

Message	Description
Settings	Press the OK button.
MyKey	Press the OK button.
Select one of the following:	
MyKey Dist.	Tracks the distance when drivers use a MyKey. The only way to delete the accumulated distance is by using an admin key to clear your MyKeys. If the distance does not accumulate as expected, then the intended user is not using the MyKey, or an admin key user recently cleared and then recreated a MyKey.
{0} MyKeys	Indicates the number of MyKeys programmed to your vehicle. Use this feature to detect how many MyKeys you have for your vehicle and determine when a MyKey has been deleted.
{0} Admin Keys	Indicates how many admin keys are programmed to your vehicle. Use this feature to determine how many unrestricted keys you have for your vehicle, and detect if an additional MyKey has been programmed.

USING MYKEY WITH REMOTE START SYSTEMS

MyKey is not compatible with non

Ford-approved, aftermarket remote start systems. If you choose to install a remote start system, see an authorized dealer for a Ford-approved remote start system.

MYKEY TROUBLESHOOTING

Condition	Potential Causes
I cannot create a MyKey.	<ul style="list-style-type: none"> • The key or transmitter used to start the vehicle does not have admin privileges. • The key or transmitter used to start the vehicle is the only admin key (there always has to be at least one admin key). • Vehicles with keyless start: The keyless start transmitter is not placed in the backup position. See Starting a Gasoline Engine (page 159). • SecuriLock passive anti-theft system is disabled or in unlimited mode.
I cannot program the configurable settings.	<ul style="list-style-type: none"> • The key or transmitter used to start your vehicle does not have admin privileges. • No MyKeys are created. See Creating a MyKey (page 58).
I cannot clear the MyKeys.	<ul style="list-style-type: none"> • The key or transmitter used to start your vehicle does not have admin privileges. • No MyKeys are created. See Creating a MyKey (page 58).
I lost the only admin key.	Purchase a new key from an authorized dealer.

MyKey™

Condition	Potential Causes
I lost a key.	Program a spare key. See Passive Anti-Theft System (page 67).
MyKey distances do not accumulate.	<ul style="list-style-type: none">• The MyKey user is not using the MyKey.• An admin key holder cleared the MyKeys and created new MyKeys.• The key system has been reset.
No MyKey functions with the keyless entry transmitter.	<ul style="list-style-type: none">• An admin transmitter is present at vehicle start.• No MyKeys are created. See Creating a MyKey (page 58).

Locks

LOCKING AND UNLOCKING

You can use the power door lock control or the remote control to lock and unlock your vehicle.

See **Tailgate** (page 239).

Power Door Locks (If Equipped)

The power door lock control is on the driver and front passenger door panels.

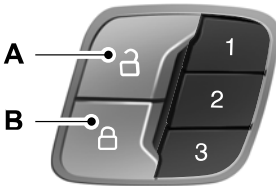

E138628

- A Unlock.
- B Lock.

Remote Control (If Equipped)

You can use the remote control at any time your vehicle is not running.

Unlocking the Vehicle (Two-Stage Unlock)



E187795

Press the button to unlock the driver door.

Press the button again within three seconds to unlock all doors. The direction indicators flash.

Press and hold both the lock and unlock buttons on the remote control for four seconds to disable or enable two-stage unlocking. Disabling two-stage unlocking allows your entire vehicle to unlock with one press of the button. The direction indicators flash twice to indicate a change to the unlocking mode. The unlocking mode applies to the remote control and keyless entry keypad.

Intelligent access at the driver door will unlock your entire vehicle when you disable two-stage unlocking.

Locking the Vehicle



E187796

Press the button to lock all doors. The direction indicators flash.

Press the button again within three seconds to confirm that all the doors are closed. The doors lock again, the horn sounds and the direction indicators flash if all the doors are closed.

Mislock

If any door is open, or if the hood is open on vehicles with an anti-theft alarm or remote start, the horn will sound twice and the direction indicators will not flash.

Locks

Activating Intelligent Access (If Equipped)

The intelligent access key must be within 3 ft (1 m) of your vehicle.

At the Front Doors

Pull a front exterior door handle to unlock and open the door. The unlock sensor is on the back of the handle. Make sure not to touch the lock sensor area on the front of the handle.



E190690

Press and hold the lock sensor area for about a second to lock your vehicle. To avoid unlocking the door inadvertently, make sure you only touch the lock sensor and not other areas of the door handle.

After locking the doors with the lock sensor, there is a brief delay before you can unlock your vehicle. This delay lets you pull the handle to make sure it locked.

Note: Keep the door handle surface clean to avoid issues with operation.

At the Electronic Tailgate



E187693

Press the exterior tailgate release button inside of the tailgate handle. The tailgate will unlock and open. See **Tailgate** (page 239).

Smart Unlock (If Equipped)

This feature helps to prevent you from locking your intelligent access key inside your vehicle's passenger compartment or rear cargo area.

If you leave your key in the ignition, when you open the driver door and lock your vehicle with the power door lock control, the doors lock then unlock.

You can still lock your vehicle with the key in the ignition by:

- Using the manual lock on the inside of the door.
- Locking the driver door with a key.
- Using the keyless entry keypad.
- Using the lock button on the remote control.

Smart Unlocks for Intelligent Access Keys (If Equipped)

This feature helps to prevent you from locking your intelligent access key inside your vehicle's passenger compartment or rear cargo area.

Locks

When you lock your vehicle using the power door lock control (with the door open, vehicle in park and ignition off), your vehicle will search for an intelligent access key in the passenger compartment after you close the door. If your vehicle finds a key, all of the doors will immediately unlock.

In order to override the smart unlock feature and intentionally lock the intelligent access key inside your vehicle, you can lock your vehicle after all doors are closed by using the keyless entry keypad, pressing the lock button on another intelligent access key or touching the locking area on the handle with another intelligent access key in your hand.

When you open one of the front doors and lock your vehicle using the power door lock control, all doors will lock then unlock if the ignition is on.

Autolock and Autounlock (If Equipped)

The autolock feature locks all the doors when your doors are closed, the ignition is on, and your vehicle reaches a speed greater than 12 mph (20 km/h).

When your doors autolock while driving, stopping the vehicle then switching the ignition off or to accessory and opening the driver door unlocks all your doors. This autounlock feature remains active for 10 minutes after stopping.

Note: *The doors do not autounlock if you have electronically locked them before opening the driver door.*

Enabling or Disabling

You can enable or disable these features independently of each other using the information display. An authorized dealer can also help you enable or disable these features. See **General Information** (page 103).

Illuminated Entry

The interior lamps and select exterior lamps illuminate when you unlock the doors with the remote entry system.

The illuminated entry system turns off the lights if:

- The ignition is on.
- You press the remote control lock button.
- After 25 seconds of illumination.

The dome lamp does not turn on if the control is set to the off position.

The lights do not turn off if:

- You switch them on with the dimmer control.
- Any door is open.

Battery Saver

The battery saver turns off the interior lamps 30 minutes after you switch off the ignition if a door is open and the dome lamp switch is on. It turns off the interior lamps after 10 minutes if the dome lamp switch is off.

Accessory Mode Battery Saver for Intelligent Access Keys (If Equipped)

If you leave the ignition on after leaving your vehicle, it turns off 15 minutes after you close all of the doors.

KEYLESS ENTRY (If Equipped)

SECURICODE™ KEYLESS ENTRY KEYPAD

The keypad is located near the driver window. It is invisible until touched and then it illuminates so you can see and touch the appropriate buttons.

Locks

Note: If you enter your entry code too fast on the keypad, the unlock function may not work. Re-enter your entry code more slowly.



E190936

You can use the keypad to:

- Lock or unlock the doors and liftgate.
- Program and erase user codes.
- Arm and disarm the anti-theft alarm.

You can operate the keypad with the factory-set five-digit entry code. The code is located on the owner's wallet card in the glove box and is available from an authorized dealer. You can also create up to five of your own five-digit personal entry codes.

Programming a Personal Entry Code

To create your own personal entry code:

1. Enter the factory-set code.
2. Press **1-2** on the keypad within five seconds.
3. Enter your personal five-digit code. You must enter each number within five seconds of each other.
4. Press **1-2** on the keypad to save personal code one.

The doors will lock then unlock to confirm that programming was successful.

To program additional personal entry codes, repeat Steps 1-3, then for Step 4:

- Press **3-4** to save personal code two.
- Press **5-6** to save personal code three.
- Press **7-8** to save personal code four.
- Press **9-0** to save personal code five.

Tips:

- Do not set a code that uses five of the same number.
- Do not use five numbers in sequential order.
- The factory-set code will work even if you have set your own personal code.

Erasing a Personal Code

1. Enter the factory-set five-digit code.
2. Press and release **1-2** on the keypad within five seconds.
3. Press and hold **1-2** for two seconds. This must be done within five seconds of completing Step 2.

All personal codes erase and only the factory-set five-digit code will work.

Recalling Memory Positions (If Equipped)

The programmed entry codes will recall driver memory positions as follows:

- Entry code one will recall driver 1 memory positions.
- Entry code two will recall driver 2 memory positions.
- Entry code three will recall driver 3 memory positions.

Note: Personal entry codes four and five will not recall memory positions

Locks

Anti-Scan Feature

The keypad will go into an anti-scan mode if you enter the wrong code seven times (35 consecutive button presses). This mode disables the keypad for one minute and the keypad lamp will flash.

The anti-scan feature will turn off after:

- One minute of keypad inactivity.
- Pressing the unlock button on the remote control.
- Switching the ignition on.
- Unlocking the vehicle using intelligent access.

Unlocking and Locking the Doors

To Unlock the Driver Door

Enter the factory-set five-digit code or your personal code. You must press each number within five seconds of each other. The interior lamps illuminate.

Note: *All doors unlock if you disable the two-stage unlocking feature. See **General Information** (page 103).*

To Unlock All Doors

Enter the factory-set code or your personal code, then press **3•4** control within five seconds.

To Lock All Doors

Press and hold **7•8** and **9•0** at the same time with the driver door closed. You do not need to enter the keypad code first.

Security

PASSIVE ANTI-THEFT SYSTEM (If Equipped)

Note: *The system is not compatible with non-Ford aftermarket remote start systems. Use of these systems may result in vehicle starting problems and a loss of security protection.*

Note: *Metallic objects, electronic devices or a second coded key on the same key chain may cause vehicle starting problems if they are too close to the key when starting the engine. Prevent these objects from touching the coded key while starting the engine. Switch the ignition off, move all objects on the key chain away from the coded key and restart the engine if a problem occurs.*

Note: *Do not leave a duplicate coded key in the vehicle. Always take your keys and lock all doors when leaving the vehicle.*

SecuriLock™

The system is an engine immobilization system. It helps prevent the engine from starting unless you use a coded key programmed to your vehicle. Using the wrong key may prevent the engine from starting. A message may appear in the information display.

If you are unable to start the engine with a correctly coded key, the system has malfunctioned. A message may appear in the information display.

Automatic Arming

The system arms immediately after you switch the ignition off.

Automatic Disarming

Switching the ignition on with a coded key disarms the system.

Replacement Keys

Note: *Your vehicle may have two integrated keyhead transmitters.*

The integrated keyhead transmitter functions as a programmed ignition key. It operates all the locks, starts the vehicle and acts as a remote control.

If your programmed transmitters or standard SecuriLock coded keys are lost or stolen and you do not have an extra coded key, you need to have your vehicle towed to an authorized dealer. You need to erase the key codes from your vehicle and program new coded keys.

Store an extra programmed key away from your vehicle in a safe place to help prevent any inconveniences. Contact an authorized dealer to purchase additional spare or replacement keys.

Programming a Spare Integrated Keyhead Transmitter

Note: *You can program a maximum of eight coded keys to your vehicle. All eight can be integrated keyhead transmitters.*

You can program your own integrated keyhead transmitter or standard SecuriLock coded keys to your vehicle. This procedure programs both the engine immobilizer keycode and the remote entry portion of the remote control to your vehicle.

Only use integrated keyhead transmitters or standard SecuriLock keys.

You must have two previously programmed coded keys and the new unprogrammed key readily accessible. Contact an authorized dealer to have the spare key programmed if two previously programmed coded keys are not available.

Read and understand the entire procedure before you begin.

Security

1. Insert the first previously programmed coded key into the ignition.
2. Switch the ignition from off to on. Keep the ignition on for at least three seconds, but no more than 10 seconds.
3. Switch the ignition off and remove the first coded key from the ignition.
4. After three seconds but within 10 seconds of switching the ignition off, insert the second previously coded key into the ignition.
5. Switch the ignition from off to on. Keep the ignition on for at least three seconds, but no more than 10 seconds.
6. Switch the ignition off and remove the second previously programmed coded key from the ignition.
7. After three seconds but within 10 seconds of switching the ignition off and removing the previously programmed coded key, insert the new unprogrammed key into the ignition.
8. Switch the ignition from off to on. Keep the ignition on for at least six seconds until you hear the door locks cycle.
9. Remove the newly programmed coded key from the ignition.

The key starts the engine if programming is successful. You can operate the remote entry system if the new key is an integrated keyhead transmitter.

If programming was not successful, wait 20 seconds and repeat Steps 1 through 8. If you are still unsuccessful, take your vehicle to an authorized dealer.

Programming a Spare Intelligent Access Key

Note: You can program a maximum of four intelligent access keys to your vehicle.

Note: If your programmed transmitters are lost or stolen and you do not have an extra coded key, you need to have your vehicle towed to an authorized dealer. You need to erase the key codes from your vehicle and program new coded keys. Store an extra programmed key away from your vehicle in a safe place to help prevent any inconvenience. Contact an authorized dealer to purchase additional spare or replacement keys.

You must have two previously programmed intelligent access keys inside your vehicle and the new unprogrammed intelligent access keys readily accessible. Contact an authorized dealer to have the spare key programmed if two previously programmed keys are not available.

Make sure that your vehicle is off before beginning this procedure. Make sure that you close all the doors before beginning and that they remain closed throughout the procedure. Perform all steps within 30 seconds of starting the sequence. Stop and wait for at least one minute before starting again if you perform any steps out of sequence.

Read and understand the entire procedure before you begin.

Type One

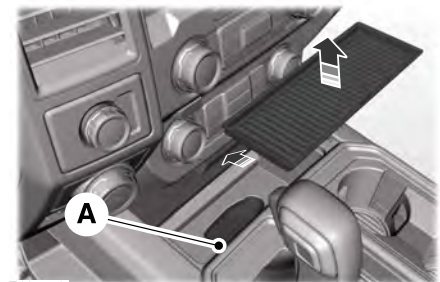

E187576

Security

Type Two



E187577

1. Place the first programmed key in the backup slot (A) in the center console, then press the push button ignition switch. Insert the first previously programmed coded key into the ignition.
2. Wait five seconds and then press the push button ignition switch again. Switch the ignition from off to on. Keep the ignition on for at least three seconds, but no more than 10 seconds.
3. Remove the intelligent access key. Switch the ignition off and remove the first coded key from the ignition.
4. Within 10 seconds, place a second programmed intelligent access key in the backup slot. Press the push button ignition switch. After three seconds but within 10 seconds of switching the ignition off, insert the second previously coded key into the ignition.
5. Wait five seconds and then press the push button ignition switch again. Switch the ignition from off to on. Keep the ignition on for at least three seconds, but no more than 10 seconds.
6. Remove the intelligent access key. Switch the ignition off and remove the second previously programmed coded key from the ignition.
7. Place the unprogrammed intelligent access key in the backup slot and press the push button ignition switch. After three seconds but within 10 seconds of switching the ignition off and removing the previously programmed coded key, insert the new unprogrammed key into the ignition.

Programming is now complete. Verify the remote control functions operate and your vehicle starts with the new intelligent access key.

If programming was not successful, wait 10 seconds and repeat Steps 1 through 7. If you are still unsuccessful, take your vehicle to an authorized dealer.

ANTI-THEFT ALARM (If Equipped)

The active anti-theft system is designed to warn you in the event of unauthorized vehicle entry and is also designed to help prevent unwanted towing of your vehicle. You can choose what is monitored by arming the system in different ways. See **Information Displays** (page 103).

The direction indicators flash and the horn sounds if the system triggers while the alarm is armed.

Take all remote controls to an authorized dealer if there is any potential alarm problem with your vehicle.

Reduced Guard (If Equipped)

To monitor the following:

- Doors.
- Hood.
- Tailgate.

Lock your vehicle using the key in the driver door lock cylinder.

Security

Full Guard (If Equipped)

To monitor the following:

- Doors.
- Hood.
- Tailgate.
- Movement inside your vehicle.
- Change in vehicle inclination, for example, unwanted towing.

Lock your vehicle using the remote control or the power door lock control with the accompanying door open and then close all doors.

Note: Do not choose full monitor mode if movement within the vehicle is likely to occur or when the vehicle is in transport.

Note: For correct operation of the interior motion detection system, make sure all windows are closed prior to arming the system. This helps prevent accidental alarm activation due to external influences and make sure of correct interior motion detection. Additionally, the interior motion sensing system will not arm if any door is ajar.

Arming the Alarm

The alarm is ready to arm when there is not a key in the ignition. Lock your vehicle to arm the alarm.

The direction indicators flash once after you lock your vehicle. This indicates the alarm is in the pre-armed mode. It fully arms after 20 seconds.

Disarming the Alarm

Disarm the alarm by any of the following actions:

- Press the power door unlock button within the 20-second pre-armed mode.
- Unlock the doors with the remote control or keyless entry keypad.

- Switch the ignition on or start your vehicle.
- Use a key in the driver door lock cylinder to unlock your vehicle, then switch the ignition on within 12 seconds.

Note: Pressing the panic button on the remote control stops the horn and direction indicators, but will not disarm the system.

Power Running Boards (If Equipped)

USING POWER RUNNING BOARDS

WARNINGS



In extreme climates, excessive ice buildup may occur, causing the running boards not to deploy. Make sure that the running boards have deployed, and have finished moving before attempting to step on them. The running boards will resume normal function once the blockage is cleared.



Turn off the running boards before jacking or placing any object under your vehicle. Never place your hand between the extended running board and your vehicle. A moving running board may cause injury.

Note: Do not use the running boards, front and rear hinge assemblies, running board motors, or the running board underbody mounts to lift your vehicle when jacking. Always use proper jacking points.

Note: The running boards may operate more slowly in cool temperatures.

Note: The running board mechanism may trap debris such as mud, dirt, snow, ice and salt. This may cause unwanted noise. If this happens, manually set the running boards to the deployed position. Then, wash the system, in particular the front and rear hinge arms, with a high-pressure car wash wand.

Automatic Power Deploy

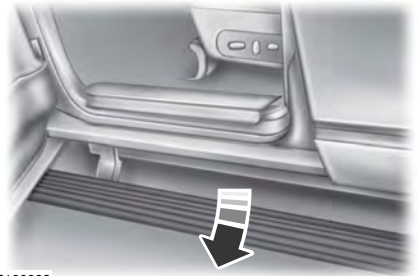

E166682

The running boards automatically extend down and out when you open the door. This can help you enter and exit your vehicle.

Automatic Power Stow

When you close the doors, the running boards return to the stowed position after a two-second delay.

Manual Power Deploy

You can manually operate the running boards in the information display. See **General Information** (page 103).

Set the running boards in the deployed position to access the roof.

The running boards return to the stowed position and enter automatic mode when the vehicle speed exceeds 5 mph (8 km/h).

Enabling and Disabling

You can enable and disable the power running board feature in the information display. See **General Information** (page 103).

Power Running Boards (If Equipped)

- When disabled (**OFF**), the running boards move to the stowed position regardless of the door position.
- When enabled (**AUTO**), the running boards move back to the correct positions based on the door position.

Bounce-back

The running board will reverse direction and move to the end of travel if it encounters an object while moving.

Steering Wheel

ADJUSTING THE STEERING WHEEL

WARNING



Do not adjust the steering wheel when your vehicle is moving.

Note: Make sure that you are sitting in the correct position. See **Sitting in the Correct Position** (page 139).



E180482

1. Unlock the steering column.
2. Adjust the steering wheel to the desired position.



E180534

3. Lock the steering column.

Power Tilt and Telescope Steering Column (If Equipped)

WARNING



Do not adjust the steering wheel when your vehicle is moving.

Note: Make sure that you are sitting in the correct position. See **Sitting in the Correct Position** (page 139).

Steering Wheel

Easy Entry and Exit Feature

The column moves to the full up and in position when you switch the ignition off. It returns to the previous setting when you switch the ignition on. You can enable or disable this feature in the information display.

AUDIO CONTROL (If Equipped)

You can operate the following functions with the control:

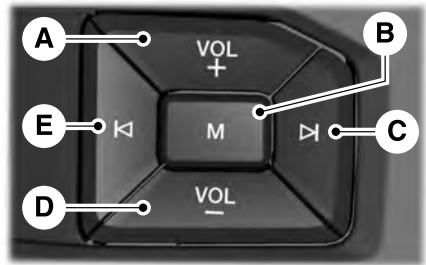

E191327

- A Volume up.
- B Media.
- C Seek up or next.
- D Volume down.
- E Seek down or previous.

Media

Press repeatedly to scroll through available audio modes.

Seek, Next or Previous

Press the seek button to:

- Tune the radio to the next or previous stored preset.
- Play the next or previous track.



E180535

Use the control on the side of the steering column to adjust the position.

To adjust:

- tilt: press the top or bottom of the control
- telescope: press the front or rear of the control.

Memory Feature

You can save and recall the steering column position with the memory function. See **Memory Function** (page 144).

Pressing the adjustment control during memory recall cancels the operation. The column responds to the adjustment control.

Steering Wheel

Press and hold the seek button to:

- Tune the radio to the next station up or down the frequency band.
- Seek through a track.

VOICE CONTROL (If Equipped)

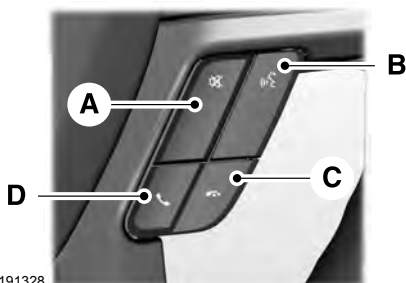

E191328

- A Mute.
- B Voice recognition.
- C End call.
- D Answer call.

See **SYNC™** (page 402). See **MyFord Touch™** (page 436).

CRUISE CONTROL (If Equipped)

Type 1



E191329

Type 2



E191337

See **Cruise Control** (page 212).

Steering Wheel

INFORMATION DISPLAY CONTROL



E191336

See **Information Displays** (page 103).

Pedals

ADJUSTING THE PEDALS (If

Equipped)

Note: Never use the controls when your feet are on the accelerator or brake pedals, especially when the vehicle is moving.

Note: Adjust the pedals only when your vehicle is in park (P).

Depending on your vehicle and equipment level, the shape and location of your power-adjustable pedal control can vary.

- If your control is vertical, then it is to the left of the steering column and on the instrument panel.
- If your control is horizontal, then it is on the left side of the steering column.

The Vertical Control

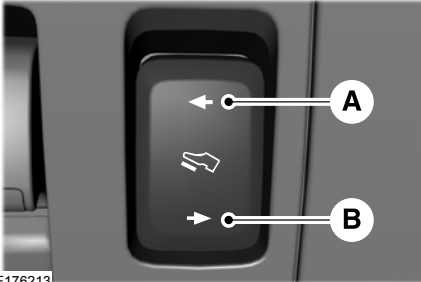

E176213

- A. Farther.
- B. Closer.

The Horizontal Control

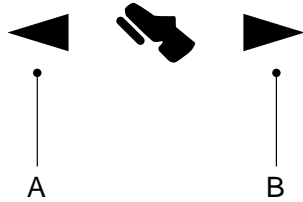

E162916

- A. Farther.
- B. Closer.

Both horizontal and vertical controls operate the same way:

1. Press and hold A to move the pedals away from you.
2. Press and hold B to move the pedals closer to you.

You can save and recall the pedal positions with the memory feature. See **Memory Function** (page 144).

Wipers and Washers

WINDSHIELD WIPERS

Note: Fully defrost the windshield before switching on the windshield wipers.

Note: Make sure you switch off the windshield wipers before entering a car wash.

Note: Clean the windshield and wiper blades if they begin to leave streaks or smears. If that does not resolve the issue, install new wiper blades.

Note: Do not operate the wipers on a dry windshield. This may scratch the glass, damage the wiper blades or cause the wiper motor to burn out. Always use the windshield washers before wiping a dry windshield.

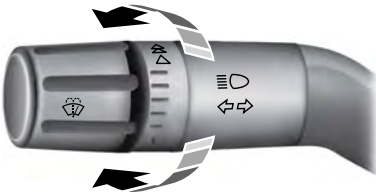

E172816

Rotate the end of the control:

- Away from you to increase the wiper speed.
- Toward you to decrease the wiper speed.

Speed dependent wipers (if equipped)

When your vehicle speed increases, the interval between wipes decreases.

AUTOWIPERS (If Equipped)

Note: Make sure you switch off the wipers before entering a car wash.

Note: Wet or winter driving conditions with ice, snow or salty road mist can cause inconsistent and unexpected wiping or smearing.

In these conditions, you can do the following to help keep your windshield clear:

- Lower the sensitivity of the autowipers.
- Change the wiper speed to normal or high-speed wipe as necessary.
- Switch the autowipers off.

The autowipers feature uses a rain sensor, located in the area around the interior mirror. The rain sensor monitors the amount of moisture on the windshield and automatically turns on the wipers. It will adjust the wiper speed by the amount of moisture that the sensor detects on the windshield. You can switch this feature on or off in the information display. See **Information Displays** (page 103).



E172817

Wipers and Washers

Use the rotary control to adjust the sensitivity of the rain sensor. With low sensitivity, the wipers will operate when the sensor detects a large amount of moisture on the windshield. With high sensitivity, the wipers will operate when the sensor detects a small amount of moisture on the windshield.

Keep the outside of the windshield clean because the rain sensor is very sensitive. If the area around the interior mirror is dirty, then the wipers may turn on, for example, if dirt, mist or insects hit the windshield.

- A brief press causes a single wipe without washer fluid.
- A brief press and hold causes the wipers to swipe three times with washer fluid.
- A long press and hold will turn on the wipers and washer fluid for up to 10 seconds.

A wipe will occur a few seconds after washing to clear any remaining washer fluid. You can switch this feature on or off in the information display. See **Information Displays** (page 103).

WINDSHIELD WASHERS

Note: Do not operate the wipers on a dry windshield. This may scratch the glass, damage the wiper blades or cause the wiper motor to burn out. Always use the windshield washer before wiping a dry windshield.

Note: Do not operate the washers when the washer reservoir is empty. This may cause the washer pump to overheat.



E172818

Lighting

LIGHTING CONTROL



E142449

- A Off.
- B Parking lamps, instrument panel lamps, license plate lamps and rear lamps.
- C Headlamps.

High Beams

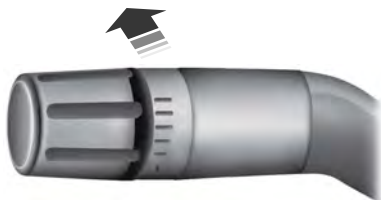

E167827

Push the lever away from you to switch the high beam on.

Push the lever forward again or pull the lever toward you to switch the high beams off.

Headlamp Flasher

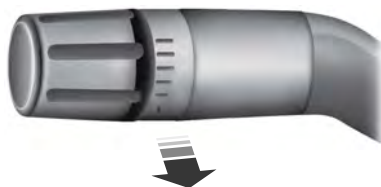

E163268

Slightly pull the lever toward you and release it to flash the headlamps.

AUTOLAMPS (If Equipped)

WARNING



The autolamps switch position may not activate the headlamps in all low visibility conditions, such as daytime fog. Always ensure that your headlamps are switched to auto or on, as appropriate, during all low visibility conditions. Failure to do so may result in a collision.

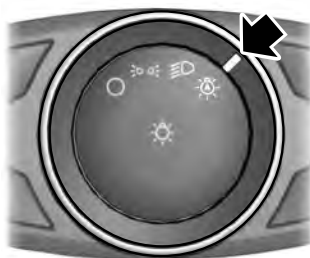

E142451

When the lighting control is in the autolamps position, the headlamps automatically turn on in low light situations or when the wipers activate.

Lighting

If equipped, the following also activate when the lighting control is in the autolamps position and you switch them on in the information display:

- Configurable daytime running lamps.
- Automatic high beam control.
- Adaptive headlamp control.

The headlamps remain on for a period of time after you switch the ignition off. Use the information display controls to adjust the period of time that the headlamps remain on. See **Information Displays** (page 103).

Note: *With the headlamps in the autolamps position, you cannot switch the high beam headlamps on until the autolamps system turns the low beam headlamps on.*

Windshield Wiper Activated Headlamps

The windshield wiper activated headlamps turn on within 10 seconds when you switch the windshield wipers on and the lighting control is in the autolamps position. They turn off approximately 60 seconds after you switch the windshield wipers off.

The headlamps will not turn on by wiper activation:

- During a mist wipe.
- When the wipers are on to clear washer fluid during a wash condition.
- If the wipers are in intermittent mode.

Note: *If you switch autolamps and autowipers on, the headlamps will automatically turn on when the windshield wipers continuously operate.*

INSTRUMENT LIGHTING DIMMER

Note: *You disable the manual dimmer when you adjust the setting to Auto Dimming in the information display. See **Information Displays** (page 103).*

Note: *If you disconnect the battery or it becomes discharged, the illuminated components will switch to the maximum setting.*

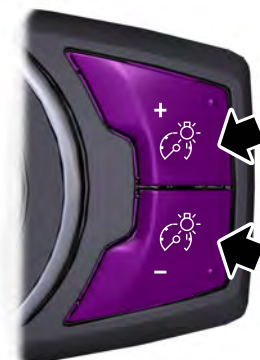

E161902

Press repeatedly or press and hold until you reach the desired level.

Lighting

DAYTIME RUNNING LAMPS (If

Equipped)

WARNING



The daytime running lamps system does not activate the rear lamps and may not provide adequate lighting during low visibility driving conditions. Also, the autolamps switch position may not activate the headlamps in all low visibility conditions, such as daytime fog. Make sure the headlamps are switched to auto or on, as appropriate, during all low visibility conditions. Failure to do so may result in a crash.

Type 1 - Conventional (Non-Configurable)

The daytime running lamps turn on when:

1. The ignition is switched to the on position.
2. The transmission is not in park (P) for vehicles with automatic transmissions or the parking brake is released for vehicles with manual transmissions.
3. The lighting control is in the off, parking lamp or autolamps positions.
4. The headlamps are off.

Type 2 - Configurable

Switch the daytime running lamps on or off using the information display controls. See **Information Displays** (page 103).

The daytime running lamps turn on when:

1. They are switched on in the information display. See **Information Displays** (page 103).
2. The ignition is switched to the on position.

3. The transmission is not in park (P) for vehicles with automatic transmissions or the parking brake is released for vehicles with manual transmissions.
4. The lighting control is in the autolamps position.
5. The headlamps are off.

The other lighting control switch positions do not activate the daytime running lamps, and you can use them to temporarily override autolamp control.

When switched off in the information display, the daytime running lamps are off in all lighting control switch positions.

AUTOMATIC HIGH BEAM CONTROL (If Equipped)

The system automatically turns on the high beams if it is dark enough and no other traffic is present. When it detects the headlights of an approaching vehicle, the tail lamps of the preceding vehicle or street lighting, the system turns off the high beams before they distract other drivers. The low beams remain on.

Note: *If it appears that automatic high beam is not functioning properly, check the windshield in front of the camera for a blockage. A clear view of the road is required for proper system operation. Make sure that authorized personnel repair any windshield damage in the area of the camera's field of view.*

Note: *If the system detects a blockage such as bird droppings, bug splatter, snow or ice, and you do not observe changes, the system may go into low beam mode until you clear the blockage. A message may also appear in the information display noting the front camera is blocked.*

Lighting

Note: Typical road dust, dirt and water spots do not affect the performance of the automatic high beam control. However, in cold or inclement weather conditions, you may notice a decrease in the availability of the automatic high beam control, especially at start up. If you want to change the beam state independently of the system, you may switch the high beams on or off using the lighting control switch. Automatic high beam control resumes when conditions are correct.

Note: Using much larger tires or equipping vehicle accessories such as snowplows can modify your vehicle's ride height and degrade automatic high beam control performance.

A camera sensor, centrally mounted behind the windshield of your vehicle, continuously monitors conditions to decide when to switch the high beams off and on.

Once the system is active, the high beams switch on if:

- The outside light level is low enough.
- There is no traffic in front of your vehicle.
- The vehicle speed is greater than 32 mph (52 km/h).

The high beams switch off if:

- The system detects the headlamps of an approaching vehicle or the rear lamps vehicle in front of you.
- Vehicle speed falls below 27 mph (44 km/h).
- The outside light level is high enough that high beams are not required.
- The system detects severe rain, snow or fog.
- The camera is blocked.

Activating the System

Switch on automatic high beam control using the information display and autolamps. See **Information Displays** (page 103).

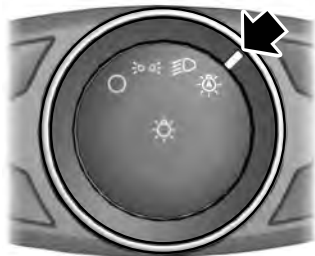

E142451

Switch the lighting control to the autolamps position.

Manually Overriding the System

When automatic high beam control has activated the high beams, pushing or pulling the stalk provides a temporary override to low beam.

Use the information display menu to permanently deactivate the system, or switch the lighting control from autolamps to headlamps.

Lighting

FRONT FOG LAMPS (If Equipped)



E142453

Press the control to switch the fog lamps on or off.

You can switch the fog lamps on when the lighting control is in any position except Off and the high beams are not on.

- To operate the left direction indicator, push the lever down until it stops and releases.
- To operate the right direction indicator, push the lever up until it stops and releases.
- To cancel direction indicator operation manually, push the lever again in either direction.

Lane Change

To indicate a left or right lane change:

- Push the lever up or down to the first stop position and release. The direction indicators flash three times and stop.
- Push the lever up or down to the first stop position and hold. The direction indicators flash for as long as you hold the lever in this position.

DIRECTION INDICATORS



E163272

The direction indicator lever does not mechanically lock in the upward or downward position when activated. The direction indicator activation and cancellation is electronic.

SPOT LAMPS (If Equipped)

The spot lamps are positioned on the forward-facing side of the exterior mirrors. When the parking lamps are on due to the lighting control switch being in the parking lamps, headlamps, or autolamps position, press the buttons located above the lighting control switch to activate the left-hand or right-hand side spot lamps.



E176842

Lighting

Once switched on, the spot lamps light the area in front of and to the side of your vehicle.

Adjust the aim of the spot lamps by moving the position of the exterior mirrors.

For manual folding mirrors, adjust the aim of the lamps by folding the exterior mirror into or away from the windows. For power-folding mirrors, use the switch located on the driver-side door. See

Exterior Mirrors (page 89).

Note: *The spot lamps turn off automatically when you reach a speed of 6 mph (10 km/h).*

Cargo and Trailer Hookup Lamps

The cargo lamps are positioned in the central high mounted stop lamp and to either side of the cargo box.

The trailer hookup lamp is positioned on the tailgate next to the handle.



To switch on the lamps, press the button located in the lighting control panel, or the button located in the cargo box near the lamp.



E190880

When switched on, these lamps light the cargo area of your vehicle and the trailer hitch.

Note: *The cargo and trailer hookup lamps turn off automatically when you reach a speed of 3 mph (5 km/h). They also turn off automatically after 10 minutes, fading gradually to off.*

INTERIOR LAMPS

The following lamps switch on when:

- You open any door.
- You press a remote control button.

Front Interior Lamps

Note: *The front interior lamp switches are on the overhead console. The exact location of each switch on the overhead console depends upon which roof, sunroof, and window shade features are equipped on the vehicle.*

Lighting

Note: Touch the required switch to switch the door function off when you open any door. When the door function is off and you open a door, the courtesy and door lamps will stay off. Touch the switch again to switch the door function back on. When the door function is on and you open a door, the courtesy and door lamps will switch on.

Type 1

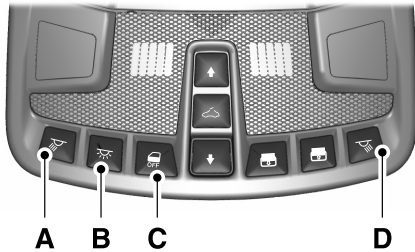

E176210

- A. Left-hand side map lamp switch.
- B. All lamps on switch.
- C. Door function switch.
- D. Right-hand side map lamp switch.

Type 2

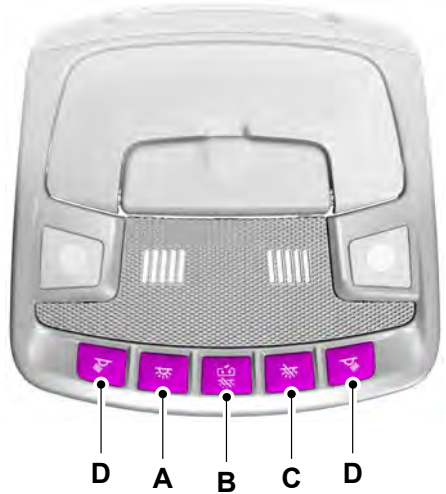

E192153

- A. All lamps on switch.
- B. Door function switch.
- C. All lamps off switch.
- D. Map lamp switches.



E187342

- A. All lamps on switch.
- B. Door function switch.

Lighting

Rear Interior Lamps (If Equipped)

You can switch the lamps on or off by pressing the button.



E187343

You can switch the lamps on or off by pressing the button.

AMBIENT LIGHTING (If Equipped)

Adjust the ambient lighting using the touchscreen. See **MyFord Touch™** (page 436). See **MyFord Touch™** (page 436).

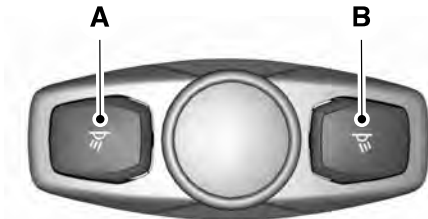

E182517

- A. Left-hand side map lamp switch.
- B. Right-hand side map lamp switch.





E187345

Windows and Mirrors

POWER WINDOWS (If Equipped)

WARNINGS

 Do not leave children unattended in your vehicle and do not let them play with the power windows. They may seriously injure themselves.

 When closing the power windows, you should verify they are free of obstructions and make sure that children and pets are not in the proximity of the window openings.

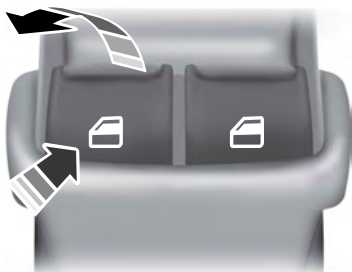

E176215

Press the switch to open the window.
Lift the switch to close the window.

Note: You may hear a pulsing noise when just one of the windows is open. Lower the opposite window slightly to reduce this noise.

One-Touch Up or Down (If Equipped)

Press or lift the switch fully and release it. Press or lift it again to stop the window.

Note: The window may disable for up to five minutes if you cycle it up and down repeatedly. This helps prevent damage to the motor. Normal operation will resume once the motor cools.

Restoring the One-Touch Up Function

You may lose the one-touch function if the vehicle battery is low.

To reset the function after the battery recharges:

1. Pull the switch all the way up.
2. Hold the switch until the glass stops and continue to hold for two seconds.
3. Press the switch down and operate the window to the full down position. One-touch up will now be functional.

Note: Perform one-touch up re-calibration with the door closed. Calibrating with the door open will cause the window to continuously bounce back.

Bounce-Back (If Equipped)

The window will stop automatically while closing. It will reverse some distance if there is an obstacle in the way.

Overriding the Bounce-Back Feature

WARNING

 When you override the bounce-back feature, the window will not reverse if it detects an obstacle. Take care when closing the windows to avoid personal injury or damage to your vehicle.

Pull up the window switch and hold within two seconds of the window reaching the bounce-back position. The window will travel up with no bounce-back protection. The window will stop if you release the switch before the window closes fully.

Windows and Mirrors

Window Lock (If Equipped)



E176216

Press the control to lock or unlock the rear window controls.

Power Sliding Back Window (If Equipped)

WARNINGS



When operating the power sliding back window, you must make sure all rear seat occupants and cargo are not in the proximity of the back window.



Do not leave children unattended in your vehicle and do not let them play with the power sliding back window. They may seriously injure themselves.

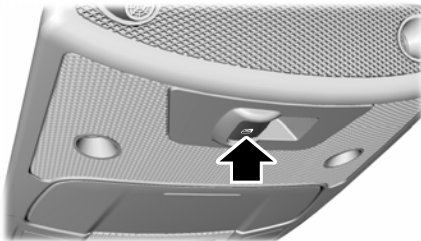

E176217

The control is on the overhead console.

Press and hold the control to open the window. Pull and hold the control to close the window.

Accessory Delay (If Equipped)

You can use the window switches for several minutes after you switch the ignition off or until you open either front door.

EXTERIOR MIRRORS

Power Exterior Mirrors (If Equipped)

WARNING



Do not adjust the mirrors when your vehicle is moving.



E144073

- A Left-hand mirror.
- B Adjustment control.
- C Right-hand mirror.

Windows and Mirrors

To adjust your mirrors, switch your vehicle on (with the ignition in accessory mode or the engine running) and then:

1. Select the mirror you want to adjust. The control lights.
2. Use the adjustment control to adjust the position of the mirror.
3. Press the mirror control again. The control light turns off.

Fold-Away Exterior Mirrors

Push the mirror toward the door window glass. Make sure that you fully engage the mirror in its support when returning it to its original position.

Telescoping Mirrors (If Equipped)

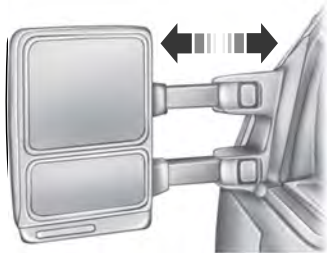

E163061

This feature lets you extend the mirror about 3 inches (75 millimeters). It is useful when towing a trailer. You can manually pull out or push in the mirrors to the desired position.

Power-Folding Mirrors (If Equipped)

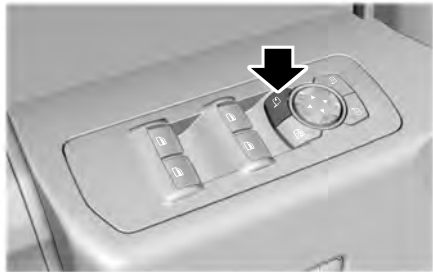

E176218

To fold both mirrors, switch your vehicle on (with the ignition in accessory mode or the engine running) and then:

1. Press the control.
2. Press control again to unfold the mirrors.

Note: Do not stop the mirrors midway through their movement. Wait until the mirrors stop moving and press the control again.

The left-hand and right-hand mirrors move at different rates. For example, one mirror may stop while the other one continues to move. This is normal.

Moving the mirrors 10 or more times within one minute, or repeated folding and unfolding of the mirrors while holding the control down during full travel, may disable the system to protect the motors from overheating. Wait approximately three minutes with the vehicle running, and up to 10 minutes with the vehicle off, for the system to reset and for function to return to normal.

Windows and Mirrors

Loose Mirror

If your power-folding mirrors are manually folded, they may not work properly even after you re-position them. You need to reset them if:

- The mirrors vibrate when you drive.
- The mirrors feel loose.
- The mirrors do not stay in the folded or unfolded position.
- One of the mirrors is not in its normal driving position.

To reset the power-fold feature, use the power-folding mirror control to fold and unfold the mirrors. You may hear a loud noise as you reset the power-folding mirrors. This sound is normal. Repeat this process as needed each time the mirrors are manually folded.

PowerScope™ Power Telescoping Mirrors (If Equipped)

This feature lets you position both mirrors at the same time.

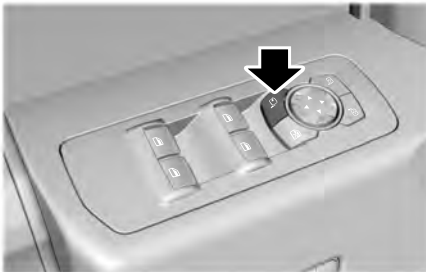

E176218

To adjust your mirrors, make sure you switch your vehicle on (with the ignition in accessory mode or the engine running) and then:

1. Press and release the control. It lights.
2. Press the adjustment control to position the mirrors.
 - Press the left arrow to extend the mirrors out. Press the right arrow to retract the mirrors in.
 - Press the up or down arrow to fold the mirrors toward the window glass. Press the up or down arrow again to fold the mirrors out.

Note: *Moving the mirrors 10 or more times within one minute, or repeated folding and unfolding of the mirrors while holding the control down during full travel, may disable the system to protect the motors from overheating. Wait approximately three minutes with the vehicle running, and up to 10 minutes with the vehicle off, for the system to reset and for function to return to normal.*

Heated Exterior Mirrors (If Equipped)

See **Heated Windows and Mirrors** (page 137).

Memory Mirrors (If Equipped)

You can save and recall the mirror positions through the memory function. See **Memory Function** (page 144).

Auto-dimming Feature (if equipped)

The driver exterior mirror automatically dims when the interior auto-dimming mirror turns on.

Windows and Mirrors

Direction Indicator Mirrors (If Equipped)

While the vehicle is running, the forward-facing portion of the appropriate mirror housing blinks when you switch on the direction indicator.

Puddle Lamps (If Equipped)

The lamps on the bottom part of the mirror housing light when you use your transmitter to unlock the doors or when you open a door.

Clearance Lamps (If Equipped)

The lower, outer part of the mirror housings light when you switch the headlamps or parking lamps on.

Spot Lamps (If Equipped)

The area lights are on the forward-facing portion of the mirror housing. You can switch them on and off by using the controls located on the instrument panel. See **Lighting** (page 80).

360-Degree Camera (If Equipped)

Each mirror includes a camera.

Integrated Blind Spot Mirror (If Equipped)

WARNING



Objects in the blind spot mirror are closer than they appear.

Blind spot mirrors have an integrated convex mirror built into the upper outboard corner of the exterior mirrors. They can assist you by increasing visibility along the side of your vehicle. The blind spot mirror is only on the driver exterior mirror.

Check the main mirror first before a lane change, then check the blind spot mirror. If no vehicles are present in the blind spot mirror and the traffic in the adjacent lane is at a safe distance, signal that you are going to change lanes. Glance over your shoulder to verify traffic is clear, and carefully change lanes.

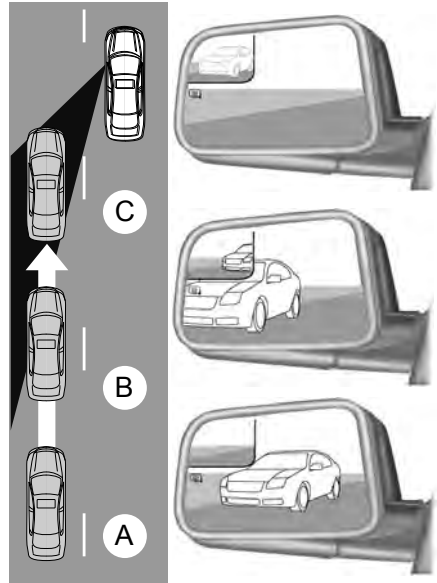

E138665

The image of the approaching vehicle is small and near the inboard edge of the main mirror when it is at a distance. The image becomes larger and begins to move outboard across the main mirror as the vehicle approaches (A). The image transitions from the main mirror and begins to appear in the blind spot mirror as the vehicle approaches (B). The vehicle transitions to your peripheral field of view as it leaves the blind spot mirror (C).

Windows and Mirrors

Blind Spot Information System (If Equipped)

See **Blind Spot Information System** (page 224).

INTERIOR MIRROR

WARNING



Do not adjust the mirror when your vehicle is moving.

Note: Do not clean the housing or glass of any mirror with harsh abrasives, fuel or other petroleum or ammonia-based cleaning products.

You can adjust the interior mirror to your preference. Some mirrors also have a second pivot point. This lets you move the mirror head up or down and from side to side.

Pull the tab below the mirror toward you to reduce glare at night.

Auto-Dimming Mirror (If Equipped)

Note: Do not block the sensors on the front and back of the mirror. Mirror performance may be affected. A rear center passenger or raised rear center head restraint may also block light from reaching the sensor.

The mirror will dim automatically to reduce glare when bright lights are detected from behind your vehicle. It will automatically return to normal reflection when you select reverse gear to make sure you have a clear view when backing up.

SUN VISORS



E138666

Rotate the sun visor toward the side window and extend it rearward for extra shade.

Illuminated Vanity Mirror (If Equipped)

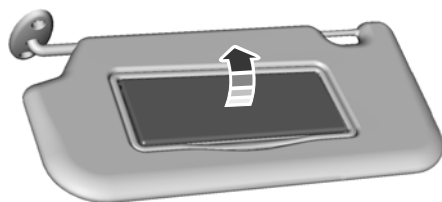

E162197

Lift the cover to switch the lamp on.

MOONROOF (If Equipped)

WARNINGS



Do not let children play with the moonroof or leave them unattended in the vehicle. They may seriously hurt themselves.

Windows and Mirrors

WARNINGS



When closing the moonroof, you should verify that it is free of obstructions and make sure that children and pets are not in the proximity of the roof opening.

The moonroof controls are located on the overhead console and have a one-touch open and close feature. To stop its movement during one-touch operation, press the control a second time.

Opening and Closing the Moonroof

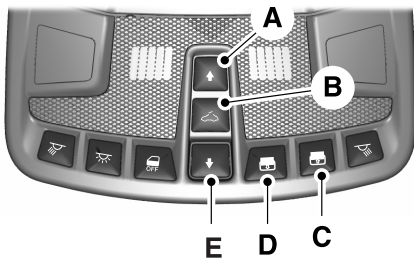

E191272

- A **Moonroof open.** Press and release to open the moonroof. The moonroof stops short of the fully opened position. Press and release the control again to open the moonroof fully.
- B **Moonroof vent.** Press and release to vent the moonroof.
- C **Sunshade open.** Press and release to open the sunshade. The sunshade opens automatically with the moonroof. You can also open the sunshade with the moonroof

closed. **Note:** The sunshade stops short of its fully opened position for the comfort of rear passengers. To open the sunshade fully, press the control again.

- D **Sunshade close.** Press and release to close the sunshade.
- E **Moonroof close.** Press and release to close the moonroof from either the open or vent positions.

Bounce-Back

The moonroof automatically reverses some distance if an obstacle is detected while closing.

To override this feature, press and hold the **moonroof close** control within two seconds after the roof comes to a stop following a bounce-back reversal.

Instrument Cluster

GAUGES

Type 1 and 2

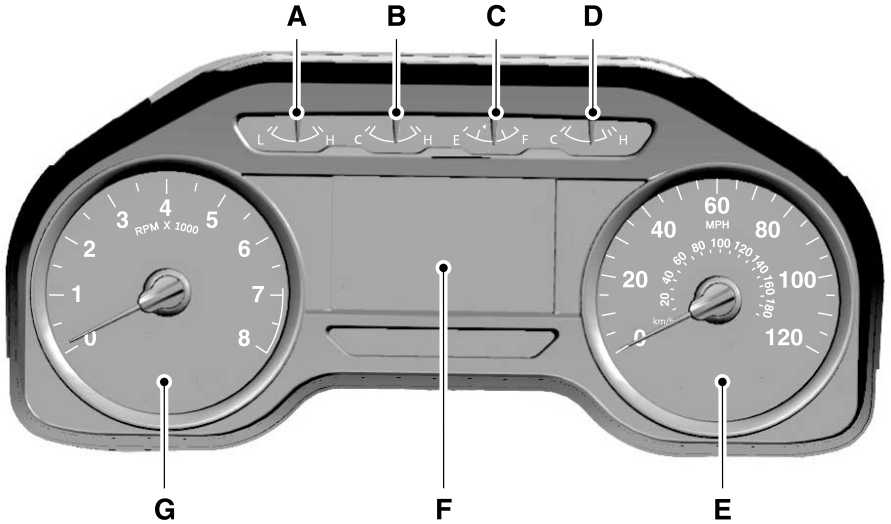

E176090

- A Engine oil pressure gauge
- B Engine coolant temperature gauge
- C Fuel gauge
- D Transmission fluid temperature gauge
- E Speedometer
- F Information display See **General Information** (page 103).
- G Tachometer

Instrument Cluster

Type 3

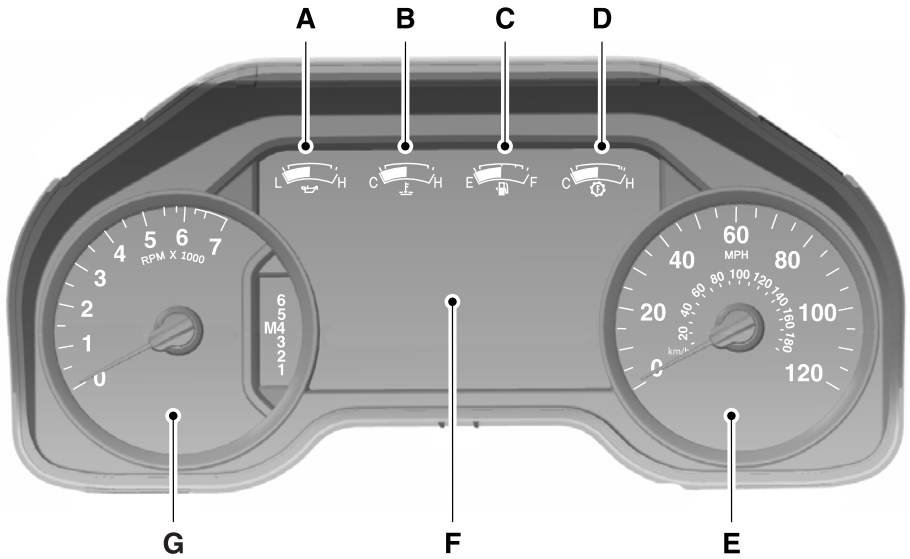

E176091

- A Engine oil pressure gauge
- B Engine coolant temperature gauge
- C Fuel gauge
- D Transmission fluid temperature or Turbo boost (Ecoboost engine only) gauge
- E Speedometer
- F Information display See **General Information** (page 103).
- G Tachometer

Instrument Cluster

Engine Oil Pressure Gauge

Indicates engine oil pressure. The needle should stay in the normal operating range (between L and H). If the needle falls below the normal range, stop your vehicle, turn off the engine and check the engine oil level. Add oil if needed. If the oil level is correct, have your vehicle checked by an authorized dealer.

Engine Coolant Temperature Gauge

WARNING



Never remove the coolant reservoir cap while the engine is running or hot.

Indicates engine coolant temperature. At normal operating temperature, the level indicator will be in the normal range. If the engine coolant temperature exceeds the normal range, stop your vehicle as soon as safely possible, switch off the engine and let the engine cool.

Fuel Gauge

Note: *The fuel gauge may vary slightly when your vehicle is moving or on a gradient.*

Variations:

Note: *The low fuel warning and distance-to-empty warning can appear at different fuel gauge positions depending on fuel economy conditions. This variation is normal.*

Driving type (fuel economy conditions)	Fuel gauge position	Distance-to-empty
Highway driving	1/16th	35 miles to 80 miles (56 km to 129 km)
Severe duty driving (trailer towing, extended idle)	1/16th-1/4	10 miles to 35 miles (16 km to 56 km)

Switch the ignition on. The fuel gauge will indicate approximately how much fuel is left in the fuel tank. The arrow adjacent to the fuel pump symbol indicates on which side of your vehicle the fuel filler door is located.

The needle should move toward F when you refuel your vehicle. If the needle points to E after adding fuel, this indicates your vehicle needs service soon.

After refueling some variability in needle position is normal:

- It may take a short time for the needle to reach F after leaving the gas station. This is normal and depends upon the slope of pavement at the gas station.
- The fuel amount dispensed into the tank is a little less or more than the gauge indicated. This is normal and depends upon the slope of pavement at the gas station.
- If the gas station nozzle shuts off before the tank is full, try a different gas pump nozzle.

Low Fuel Reminder

A low fuel reminder triggers when the fuel gauge needle is at 1/16th or about 35 miles (56km) to empty, whichever occurs first.

Instrument Cluster

Transmission Fluid Temperature Gauge

Indicates transmission fluid temperature. At normal operating temperature, the level indicator will be in the normal range. If the transmission fluid temperature exceeds the normal range, stop the vehicle as soon as safely possible and verify the airflow is not restricted such as snow or debris blocking airflow through the grill. Also, higher than normal operating temperature can be caused by special operation conditions (i.e. snowplowing, towing or off-road use). Refer to Special operating conditions in the scheduled maintenance information for instructions. Operating the transmission for extended periods with the gauge in the higher than normal area may cause internal transmission damage. You need to alter the severity of your driving conditions to lower the transmission temperature into the normal range. If the gauge continues to show high temperatures, see an authorized dealer.

Information Display

Odometer

Located in the bottom of the information display. Registers the accumulated distance your vehicle has traveled.

Compass

Displays the vehicle's heading direction.

Trip Computer

See **General Information** (page 103).

Vehicle Settings and Personalization

See **General Information** (page 103).

WARNING LAMPS AND INDICATORS

The following warning lamps and indicators will alert you to a vehicle condition that may become serious. Some lamps will illuminate when you start your vehicle to make sure they work. If any lamps remain on after starting your vehicle, refer to the respective system warning lamp for further information.

Note: *Some warning indicators appear in the information display and function the same as a warning lamp but do not display when you start your vehicle.*

Adaptive Cruise Control (If Equipped)



The speed control system indicator light changes color to indicate what mode the system is in: See **Using Adaptive Cruise Control** (page 213).

Anti-Lock Braking System



If it illuminates when you are driving, this indicates a malfunction. You will continue to have normal braking (without Anti-lock braking system) unless the brake system warning lamp is also illuminated. Have the system checked by an authorized dealer.

Automatic High Beam (If Equipped)



Illuminates when this feature is on. See **Automatic High Beam Control** (page 82).

Auto Start-stop (If Equipped)



It will illuminate to inform you when the engine shuts down or in conjunction with a message.

Instrument Cluster

Battery



If it illuminates while driving, it indicates a malfunction. Switch off all unnecessary electrical equipment and have the system checked by an authorized dealer immediately.

Blind Spot Monitor (If Equipped)



It will illuminate when you switch this feature off or in conjunction with a message. See **Blind Spot Information System** (page 224).

Brake System



It will illuminate when you engage the parking brake with the ignition on.

If it illuminates when you are driving, check that you do not have the parking brake engaged. If you do not have the parking brake engaged, this indicates low brake fluid level or a brake system malfunction. Have the system checked immediately by an authorized dealer.

WARNING



Driving your vehicle with the warning lamp on is dangerous. A significant decrease in braking performance may occur. It will take you longer to stop your vehicle. Have your vehicle checked by your authorized dealer immediately. Driving extended distances with the parking brake engaged can cause brake failure and the risk of personal injury.

Check 4X4 (If Equipped)



Illuminates with the message CHECK 4X4 when a four-wheel drive fault is present. See **Using Four-Wheel Drive** (page 180).

Cruise Control (If Equipped)



Illuminates gray or green when you switch this feature on. See **Using Cruise Control** (page 212).

Direction Indicator



Illuminates when the left or right turn signal or the hazard warning flasher is turned on. If the indicators stay on or flash faster, check for a burned out bulb.

Door Ajar



Displays when the ignition is on and any door is not completely closed.

Electronic Locking Differential



Illuminates when using the electronic locking differential.

Electric Park Brake (If Equipped)



It will illuminate or flash when the electric parking brake has a malfunction. See **Electric Parking Brake** (page 191).

Engine Coolant Temperature



Illuminates when the engine coolant temperature is high. Stop the vehicle as soon as possible, switch off the engine and let cool. See **Engine Coolant Check** (page 304).

Instrument Cluster

Engine Oil



If it illuminates with the engine running or when you are driving, this indicates a malfunction.

Stop your vehicle as soon as it is safe to do so and switch the engine off. Check the engine oil level. See **Engine Oil Check** (page 303).

Note: Do not resume your journey if it illuminates despite the level being correct. Have the system checked by your authorized dealer immediately.

Fasten Safety Belt



It will illuminate and a chime will sound to remind you to fasten your safety belt.

Four-Wheel Drive Indicators (if

Equipped)

Note: Some indicators will appear different depending on vehicle options.

4x2

2H

Illuminates momentarily when you select two-wheel drive high.

4A

Illuminates when the automatic four-wheel drive system is engaged.

4x4
LOW

4L

Illuminates when four-wheel drive low is engaged.

4x4
HIGH

4H

Illuminates when four-wheel drive high is engaged.

Front Airbag



If it fails to illuminate when you start your vehicle, continues to flash or remains on, it indicates a malfunction. Have the system checked by an authorized dealer.

Front Fog Lamps (If Equipped)



It will illuminate when you switch the front fog lamps on.

High Beam



Illuminates when you switch the high beam headlamps on. It will flash when you use the headlamp flasher.

Hill Descent (If Equipped)



Illuminates when hill descent is switched on.

Low Fuel Level



Illuminates when the fuel level is low or the fuel tank is nearly empty. Refuel as soon as possible.

Low Tire Pressure Warning



Illuminates when your tire pressure is low. If the lamp remains on with the engine running or when driving, check your tire pressure as soon as possible.

Instrument Cluster

It will also illuminate momentarily when you switch the ignition on to confirm the lamp is functional. If it does not illuminate when you switch the ignition on, or begins to flash at any time, have the system checked by your authorized dealer.

Parking Lamps



It will illuminate when you switch the parking lamps on.

Powertrain Malfunction/Reduced Power/Electronic Throttle Control



Illuminates when the system has detected a powertrain or an all-wheel drive fault. Contact an authorized dealer as soon as possible.

Service Engine Soon



If the service engine soon indicator light stays illuminated after you start the engine, it indicates that the On Board Diagnostics system (OBD) has detected a malfunction of your vehicle emissions control system. Refer to On board diagnostics (OBD) in the Fuel and Refueling chapter for more information about having your vehicle serviced. See **Emission Control System** (page 171).

If the light is blinking, engine misfire is occurring which could damage your catalytic converter. Drive in a moderate fashion (avoid heavy acceleration and deceleration) and have your vehicle serviced immediately.

WARNING



Under engine misfire conditions, excessive exhaust temperatures could damage the catalytic converter, the fuel system, interior floor coverings or other vehicle components, possibly causing a fire. Have an authorized dealer service your vehicle immediately.

When you first switch the ignition on, before engine start, the service engine soon indicator light illuminates to check the bulb and to indicate whether your vehicle is ready for inspection maintenance testing.

Normally, the service engine soon light will stay on until you crank the engine, and then turn itself off if no malfunctions are present. However, if after 15 seconds the service engine soon light blinks eight times, it means that your vehicle is not ready for inspection maintenance testing. See **Emission Control System** (page 171).

Sport Mode



Illuminates when you switch the sport mode on.

Traction and Stability Control



Illuminates when the system is active. If it remains illuminated or does not illuminate when you switch the ignition on, this indicates a malfunction. During a malfunction the system will switch off. Have the system checked by an authorized dealer immediately. See **Using Stability Control** (page 197).

Traction and Stability Control Off



Illuminates when you switch the system off. It will go out when you switch the system back on or when you switch the ignition off. See **Using Stability Control** (page 197).

Instrument Cluster

Transmission Tow/Haul (If Equipped)



Illuminates when the tow/haul feature has been activated. If the light flashes steadily, have the system serviced immediately, damage to the transmission could occur. See **Automatic Transmission** (page 174).

AUDIBLE WARNINGS AND INDICATORS

Airbag Secondary Warning

Sounds if there is a malfunction with the safety belt warning lamp and there is a fault in the supplemental restraints system.

Beltminder Warning

Sounds when a safety belt is unfastened in an occupied seat and your vehicle is moving.

Door Ajar Warning

Sounds when any door is not completely closed and your vehicle speed exceeds 3 mph (5 km/h).

Headlamps On Warning

Sounds when you remove the key from the ignition and open the driver's door and you have left the headlamps or parking lamps on.

Key in Ignition Warning

Sounds when you open the driver's door and you have left the key in the ignition.

Keyless Warning Alert (If Equipped)

Sounds the horn twice when you exit your vehicle with the intelligent access key, after the last door is closed and your keyless vehicle is in RUN, indicating your vehicle is still on.

Rear Park Aid Warning

A detection warning sounds when obstacles are within a certain range of the bumper area. The system turns on automatically whenever you switch the ignition on.

Parking Brake On Warning

Sounds when you have left the parking brake on and drive your vehicle. If the warning chime remains on after you have released the parking brake, have the system checked by your authorized dealer immediately.

Service Advancetrac Warning

Sounds when there is a malfunction with the Electronic Stability Control (ESC) or Rollover Stability Control (RSC) system.

Information Displays

GENERAL INFORMATION

WARNING



Driving while distracted can result in loss of vehicle control, crash and injury. We strongly recommend that you use extreme caution when using any device that may take your focus off the road. Your primary responsibility is the safe operation of your vehicle. We recommend against the use of any handheld device while driving and encourage the use of voice-operated systems when possible. Make sure you are aware of all applicable local laws that may affect the use of electronic devices while driving.

Various systems on your vehicle can be controlled using the information display controls on the steering wheel. Corresponding information is displayed in the information display.

Information Display Controls (Type 1 and 2)



E176092

- Press the up and down arrow buttons to scroll through and highlight the options within a menu.
- Press the right arrow button to enter a sub-menu.
- Press the left arrow button to exit a menu.
- Press the **OK** button to choose and confirm a setting or messages.

Main menu (Type 1)

- Trip 1 & 2
- Fuel economy
- Driver assist
- Settings

Information Displays

Note: Some options may appear slightly different or not at all if the items are optional.

Trip 1 & 2

Note: Use the arrow buttons to choose between the following trip options.

Trip 1 & 2
Digital Speed - Press OK for km/h
Trip Odometer
Trip Timer
Fuel Used
Average Fuel

- Digital Speed - Shows a digital display of your vehicle speed.
- Trip Odometer - Registers the mileage of individual journeys.
- Trip Timer - Registers the time of individual journeys.
- Fuel Used - Shows the amount of fuel used for a given trip.
- Average Fuel - Shows the average fuel economy for a given trip.

Note: Press and hold **OK** to reset the currently displayed trip information.

Fuel Economy

Note: Use the arrow buttons to choose the desired fuel economy display.

Fuel economy
Distance to E
Instant Fuel Economy
Average Fuel Economy
Auto StartStop status

- Distance to E - Shows the approximate distance your vehicle can travel before running out of fuel.
- Instant Fuel Economy - Shows your instantaneous fuel usage.
- Average Fuel Economy - Shows the average fuel usage based on time. Press and hold **OK** to reset this value.
- Auto StartStop status - Shows the current status of the auto startstop system.

Note: You can reset your average fuel economy by pressing and holding the **OK** button on the left hand steering wheel controls.

Information Displays

Driver Assist

Note: Use the arrow buttons to configure different driver setting choices.

Driver Assist		
Driver Assist	Engine Hour	Engine Hours XXXXXX
		Engine Idle Hours XXXXXX
	Tire Pressure	Vehicle graphic with tire pressures
	Rear Park Aid - check enabled or uncheck disabled	
	Trlr Brake	Electric
		Elect.ov.Hydro.
Trailer Sway Control - check enabled or uncheck disabled		

Note: Some items are optional and may not appear.

Tire Pressure



E185360

Displays your current vehicle tire pressures.

Settings

Settings		
Vehicle	DTE Calc.	Normal
		Towing
Lighting	Autolamp Delay	Off or XXX seconds
	Daytime Lights - check enabled or uncheck disabled	
Locks	Autounlock - check enabled or uncheck disabled	

Information Displays

Settings			
		Mislock - check enabled or uncheck disabled	
		Remote Unlock	Driver's Door or All Doors
	Oil Life Reset	Remaining Life XX% - Hold OK to reset	
	Remote Start	Climate Control	Auto or Last setting
		Duration	5, 10 or 15 minutes
		System - check enabled or uncheck disabled	
	Wipers	Courtesy Wipe - check enabled or uncheck disabled	
MyKey	MyKey Status	Admin Keys and MyKeys	
		MyKey Mileage	
	Create MyKey	Hold OK to Create MyKey	
	911 Assist	Always On or Selectable	
	Do Not Disturb	Always On or Selectable	
	AdvanceTrac	Always On or Selectable	
	Max Speed	Choose desired speed or Off	
	Speed Minder	Choose desired speed or Off	
	Volume Limiter - check enabled or uncheck disabled		
	Clear MyKeys	Clear MyKeys - Press OK to clear MyKeys	
Display Setup	Distance	Miles & Gallons, L/100km or km/L	
	Temperature	°Fahrenheit or °Celsius	
	Tire Pressure	psi, kPa or bar	
	Language	Choose your applicable setting	

Main menu (Type 2)

- Display Mode
- Trip/Fuel
- Towing

- Off Road
- Settings

Note: Some options may appear slightly different or not at all if the items are optional.

Information Displays

Display Mode

Note: Use the arrow buttons to choose between the following display options.

Display Mode
DTE
Transmission Temp
Tire Pressure
Digital Speedometer - Press OK for km/h
Engine Information - Oil Life, Engine Hours, Engine Idle Hours - Hold OK to Reset
MyKey Status - Admin Keys and MyKey Mileage

- DTE - Shows the approximate distance your vehicle can travel before running out of fuel.
- Transmission Temp - Shows the trans temp value.
- Tire Pressure - Shows the tire pressure psi.
- Engine Information - Shows engine information.
- MyKey Status - Shows the status of your MyKeys.

Tire Pressure



E184771

Displays your current vehicle tire pressures.

Trip/Fuel

Note: Use the arrow buttons to choose between the following trip and fuel options.

Information Displays

Trip/Fuel	
Trip 1 or 2	
Fuel Economy	
Fuel History	
Compass - Press OK for Options	Fixed North or Rotating North
Auto StartStop status	

Trip 1 or 2

- Trip Timer - Registers the time of individual journeys.
- Gal used - Shows the amount of fuel used for a given trip.
- Mi - Registers the mileage of individual journeys.
- Avg mpg - Shows the average fuel economy for a given trip.

Fuel

- Fuel Economy - Shows your instantaneous fuel usage as a bar graph and average mpg.
- Fuel History - Shows your fuel usage based on time. The graph is updated each minute with the fuel economy that you achieved during 30 minutes of driving.
- Auto StartStop status - Shows the current status of the auto startstop system.

Note: Press and hold **OK** to reset the currently displayed information.

Towing

Note: Use the arrow buttons to configure different towing setting choices.

Note: Trailer options are not available if your vehicle speed is greater than 3mph (5km/h).

Towing		
Trailer Status	Trailer connection status	
	active trailer name or Default Trailer	
	accumulated trailer miles	
	Trailer brake gain	
	Output	
Trailer Options	Trailer Sway Control - check enabled or uncheck disabled	
	Change Trailer Selected	no active trailer
		Programmed trailers

Information Displays

Towing				
Connection Checklist		Default Trailer		
	Change Trailer Settings	Rename Trailer	List of named trailers, No Stored Trailers - Press OK to rename	
		Reset Trailer Mileage	List of named or default trailers - Press OK to select	
		Change Trailer Brake Type	Default (Electric, Surge, None) or Electric over Hydraulic	
		Delete Trailer	List of named trailers, No stored trailers - Press OK to select	
		Change Trailer Setup	List of named trailers or default trailers - Press OK to Select	
	Add Trailer	New Trailer - Press OK to select		
		Trailer Brake Mode	Default (Electric, Surge, None) or Elect over Hydraul	
	Conventional, Fifth Wheel or Gooseneck			

Note: Some items are optional and may not appear.

Off Road

Note: Use the arrow buttons to configure different off road choices.

Off Road
Pitch, steering angle and roll
Power Distribution

Information Displays

Settings

Settings				
Blindspot - check enabled or uncheck disabled				
Cross Traffic Alert - check enabled or uncheck disabled				
Park Aid - check enabled or uncheck disabled				
DTE Calculation	Normal			
	Towing			
Advanced Settings	Vehicle	Easy Entry/Exit - check enabled or uncheck disabled		
		Lighting	Autolamp Delay	Off or XXX seconds
			Daytime Lights - check enabled or uncheck disabled	
		Locks	Autolock - check enabled or uncheck disabled	
			Autounlock - check enabled or uncheck disabled	
		Remote Start	Remote Unlock	Drivers Door or All Doors
			Climate Control	Auto or Last setting
		Seats	Auto or Off	
		Duration	5, 10 or 15 minutes	
		System - check enabled or uncheck disabled		
	Wipers	Courtesy Wipe or Rain Sensing - check enabled or uncheck disabled		
	MyKey	Create MyKey	Hold OK to Create MyKey	
		911 Assist	Always On or User Selectable	
		Do Not Disturb	Always On or User Selectable	
		AdvanceTrac	Always On or User Selectable	

Information Displays

Settings			
		MAX Speed	65, 70, 75, 80 MPH (105, 115, 120, 130 km/h) or Off
		Speed Minder	45, 55 or 65 MPH (75, 90, 100 km/h) or Off
		Volume Limiter	check enabled or uncheck disabled
		Clear MyKey	Hold OK to Clear MyKeys
	Display Setup	Distance	Miles & Gallons, L/100km or km/L
		Temperature	°Fahrenheit or °Celsius
		Tire Pressure	psi, kPa or bar
		Language	Choose your applicable setting

Information Display Controls (Type 3) (If Equipped)

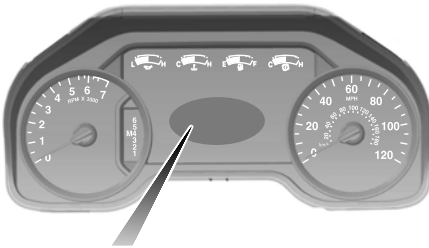

E176093

- Press the up and down arrow buttons to scroll through and highlight the options within a menu.
- Press the right arrow button to enter a sub-menu.
- Press the left arrow button to exit a menu.
- Press the **OK** button to choose and confirm a setting or messages.

Main menu

You can access the menus using the information display control.

-  My View
-  Trip/Fuel
-  Truck Info
-  Towing
-  Off Road

Information Displays



Settings

My View



Use the arrow buttons to choose between the following My View options.

My View			
Configure My View	Add/Remove Screens	Trip/Fuel	Trip 1
			Trip 2
			Fuel Economy
			Fuel History
			Navigation/Compass
			Auto Start/Stop
		Truck Info	Tire Pressure Monitor
			Digital Speedometer
			Engine Information
			MyKey Status
	Towing	Trailer Status	
		Trailer Information	
		Trailer Light Check	
	Off Road	Off Road Status	
		Power Distribution	
Reorder Screens	Screen Selection 1 - 7	Up/Down moves selection in the list	
	Press OK to select		

Trip/Fuel



Use the arrow buttons to choose between the following trip and fuel options.

Information Displays

Trip/Fuel	
Trip 1 or 2	
Fuel Economy	
Fuel History	
Navigation	
Compass - Press OK for Options	Fixed North or Rotating North
Auto StartStop status	

Trip 1 or 2

- Trip Timer - Registers the time of individual journeys.
- Gal used - Shows the amount of fuel used for a given trip.
- Mi - Registers the mileage of individual journeys.
- Avg mpg - Shows the average fuel economy for a given trip.

Fuel

- Fuel Economy - Shows your instantaneous fuel usage as a bar graph and average mpg.
- Fuel History - Shows your fuel usage based on time. The graph is updated each minute with the fuel economy that you achieved during 30 minutes of driving.
- Navigation - Shows navigation turn by turn (Compass displayed when a route in Navigation is not set).
- Auto StartStop status - Shows the current status of the auto startstop system.

Note: Press and hold **OK** to reset the currently displayed information.

Truck Info

Note: Some items are optional and may not appear.



In this mode, off-road information depicted with graphics are available.

Note: Use the arrow buttons to choose between the following display options.

Truck Info
Gauge View
Tire Pressure
Digital Speedometer - Press OK for km/h

Information Displays

Truck Info
Engine Information - Oil Life, Engine Hours, Engine Idle Hours - Hold OK to Reset
MyKey Status - Admin Keys, MyKeys and MyKey Mileage

- Gauge View - Shows the turbo boost or transmission temp value.
- Tire Pressure - Shows the tire pressure psi.
- Digital Speedometer - Shows a digital display of your vehicle speed.
- Engine Information - Shows engine information.
- MyKey Status - Shows the status of your MyKeys.

Tire Pressure



E184771

Displays your current vehicle tire pressures.

Towing



Use the arrow buttons to choose between the following towing options.

Note: Trailer options are not available if your vehicle speed is greater than 3mph (5km/h).

Towing	
Towing Status	Pitch Angle, steering angle, gain and output display
Towing Information	Trailer Name, Accumulated Miles - Press OK for Trailer Options
Trailer Light Status	Running, Brake/Turn Signal Light Status or No Trailer Detected
Trailer Setup - Press OK for Trailer Options	Trailer Sway Control - check enabled or uncheck disabled

Information Displays

Towing			
Connection Check-list	Select Trailer	no active trailer	
		Programmed trailers	
		Default Trailer	
	Change Trailer Settings	Rename Trailer	List of named trailers, No Stored Trailers - Press OK to rename
		Reset Trailer Mileage	List of named or default trailers - Press OK to select
		Trailer Brake Type	Default (Electric, Surge, None) or Electric over Hydraulic
		Delete Trailer	List of named trailers, No stored trailers - Press OK to select
		Change Trailer Setup	Conventional, Fifth Wheel or Goose-neck
	Add Trailer	New Trailer - Press OK to select	
		Trailer Brake Mode	Default (Electric, Surge, None) or Electric over Hydraulic
Conventional, Fifth Wheel or Gooseneck - Press OK to Select			

Off Road



Use the arrow buttons to choose between the following off road options.

Information Displays

Off Road
Pitch, steering angle, roll, Elocker and 4X4
Power Distribution

Settings

Note: Some items are optional and may not appear.



Use the arrow buttons to configure different driver setting choices.

Settings			
Auto High Beam - check enabled or uncheck disabled			
Blindspot - check enabled or uncheck disabled			
Cross Traffic Alert - check enabled or uncheck disabled			
Driver Alert - check enabled or uncheck disabled			
Rear Park Aid - check enabled or uncheck disabled			
Collision Warn	Sensitivity	High, Normal or Low	
	Warn	On or Off	
Cruise Control	Adaptive or Normal		
Lane keeping Sys	Mode	Alert only, Aid only or both	
	Intensity	High, Normal or Low	
DTE Calculation	Normal or Towing		
	Vehicle	Auto Engine Off - check enabled or uncheck disabled	
		Easy Entry/Exit - check enabled or uncheck disabled	
	Lighting	Autolamp Delay	Off or XXX seconds
		Daytime Lights - check enabled or uncheck disabled	
	Locks	Autounlock - check enabled or uncheck disabled	

Information Displays

Settings				
Advanced Settings			Mislock - check enabled or uncheck disabled	
		Remote Unlock	All Doors or Driver First	
		Alarm	All Sensors or Perimeter Sensing	
			Ask on Exit - check enabled or uncheck disabled	
		Power Running Boards	Auto, Off or Out	
		Remote Start	Climate Control	Auto or Last setting
			Front Seats or Front Seats and Wheel	Auto or Off
			Duration	5, 10 or 15 minutes
			System - check enabled or uncheck disabled	
		Wiper Controls	Courtesy Wipe or Rain Sensing	
	MyKey	Create MyKey	Hold OK to Create MyKey	
		911 Assist	Always On or User Selectable	
		Do Not Disturb	Always On or User Selectable	
		AdvanceTrac	Always On or User Selectable	
		MAX Speed	65, 70, 75, 80 MPH (105, 115, 120, 130 km/h) or Off	
		Speed Minder	45, 55 or 65 MPH (75, 90, 100 km/h) or Off	
		Volume Limiter - check enabled or uncheck disabled		
	Clear MyKey	Hold OK to Clear MyKeys		
	Display Setup	Distance	Miles & Gallons, L/100km or km/L	

Information Displays

Settings			
		Temperature	°Fahrenheit or °Celsius
		Tire Pressure	psi, kPa or bar
		Language	Choose your applicable setting

INFORMATION MESSAGES

Note: Depending on your vehicle options and instrument cluster type, not all of the messages will display or be available. The information display may abbreviate or shorten certain messages.



E184451

Press the **OK** button to acknowledge and remove some messages from the information display. The information display will automatically remove other messages after a short time.

You need to confirm certain messages before you can access the menus.

Active Park

Message	Action
Active Park Fault	The system requires service due to a malfunction. Have the system checked by an authorized dealer.

Information Displays

Adaptive Cruise Control

Message	Action
Adaptive Cruise Malfunction	A radar malfunction is preventing the adaptive cruise control from engaging. See Using Adaptive Cruise Control (page 213).
Adaptive Cruise Not Available	A condition exists such that the adaptive cruise cannot function properly. See Using Adaptive Cruise Control (page 213).
Adaptive Cruise Not Available Sensor Blocked See Manual	You have a blocked sensor due to bad weather, ice, mud or water in front of the radar sensor. You can typically clean the sensor to resolve. See Using Adaptive Cruise Control (page 213).
Normal Cruise Active Automatic Braking Turned Off	The system has disabled the automatic braking.
Front Sensor Not Aligned	A radar malfunction is preventing the adaptive cruise control from engaging.
Adaptive Cruise - Driver Resume Control	The adaptive cruise has reinstated controls to the driver.
Adaptive Cruise Speed Too Low to Activate	Your vehicle speed is too slow to activate the adaptive cruise.
Adaptive Cruise Shift Down	The adaptive cruise is automatically adjusting the gap distance and you need to shift the transmission into a lower gear.

AdvanceTrac and Traction Control

Message	Action
Service AdvanceTrac	The system detects a condition that requires service. Contact an authorized dealer as soon as possible.
AdvanceTrac Off	The status of the AdvanceTrac system after you switched it off.
AdvanceTrac On	The status of the AdvanceTrac system after you switched it on.

Information Displays

Message	Action
AdvanceTrac SPORT MODE	The status of the AdvanceTrac sport mode after you switched it on.
Traction Control Off	The status of the traction control system after you switched it off. See Using Traction Control (page 195).
Traction Control On	The status of the traction control system after you switched it on. See Using Traction Control (page 195).

Airbag

Message	Action
REMOVE OBJECTS NEAR PASSENGER SEAT	Displays when the system detects a malfunction due to a blocked sensor.

Alarm and Security

Message	Action
Vehicle Alarm to Stop Alarm, Start Vehicle	Alarm triggered due to unauthorized entry. See Anti-Theft Alarm (page 69).

Information Displays

Battery and Charging System

Message	Action
Check Charging System	The charging system needs servicing. If the warning stays on or continues to come on, contact an authorized dealer as soon as possible.
Low Battery Features Temporarily Turned Off	The battery management system detects an extended low-voltage condition. Your vehicle will disable various features to help preserve the battery. Turn off as many of the electrical loads as soon as possible to improve system voltage. If the system voltage has recovered, the disabled features will operate again as normal.
Turn Power Off to Save Battery	The battery management system determines that the battery is at a low state of charge. Turn your ignition off as soon as possible to protect the battery. This message will clear once you restart your vehicle and the battery state of charge has recovered. Turning off unnecessary electrical loads will allow faster battery state-of-charge recovery.

Blind Spot Information and Cross Traffic Alert System

Message	Action
Blindspot System Fault	A fault with the system has occurred. Contact an authorized dealer as soon as possible.
Blindspot Not Available Sensor Blocked See Manual	The system sensors are blocked. See Blind Spot Information System (page 224).
Cross Traffic Vehicle Coming From X	The system detects a vehicle. See Blind Spot Information System (page 224).
Cross Traffic Not Available Sensor Blocked See Manual	The blind spot information system and cross traffic alert system sensors are blocked. See Blind Spot Information System (page 224).
Cross Traffic System Fault	A fault with the system has occurred. Contact an authorized dealer as soon as possible.

Information Displays

Collision Warning System

Message	Action
Collision Warning Malfunction	A fault with the system has occurred. Contact an authorized dealer as soon as possible.
Collision Warning Not Available Sensor Blocked See Manual	You have a blocked sensor due to bad weather, ice, mud or water in front of the radar sensor. You can typically clean the sensor to resolve. See Collision Warning System (page 230).
Collision Warning Not Available	A fault with the system has occurred. Contact an authorized dealer as soon as possible.

Doors and Locks

Message	Action
X Door Ajar	The door(s) listed is not completely closed.

Driver Alert

Message	Action
Driver Alert Warning Rest Now	Stop and rest as soon as it is safe to do so.
Driver Alert Warning Rest Suggested	Take a rest break soon.

Drivetrain

Message	Action
Locking Differential Engaged/Disengaged	The electronic locking differential (ELD) is enabled or disabled.
To Engage Locking Differential Slow to XX mph/km/h	The electronic locking differential requests a certain speed requirement to engage.
To Engage Locking Differential Release Accelerator Pedal	The electronic locking differential request the accelerator to be released in order to engage.

Information Displays

Message	Action
Check Locking Differential	An electronic locking differential (ELD) system fault is present. See Using Four-Wheel Drive (page 180).
Neutral Tow Enabled Leave Transmission in Neutral	The transfer case is in the neutral position. This message indicates that your vehicle is safe to be towed with all four wheels on the ground.
Neutral Tow Disabled	The transfer case is NOT in the neutral position. This message indicates that your vehicle is NOT safe to be towed with all four wheels on the ground.

Engine

Message	Action
Power Reduced to Lower Engine Temp	The engine has reduced power to help reduce high engine temperature.

Fuel

Message	Action
Fuel Level Low	An early reminder of a low fuel condition.
Check Fuel Fill Inlet	The fuel fill inlet may not be properly closed.

Keys and Intelligent Access

Message	Action
Press Brake to START	A reminder to press the brake while starting the vehicle.
No Key Detected	The system does not detect a key in your vehicle. See Keyless Starting (page 158).
Restart Now or Key is Needed	You pressed the StartStop button to switch off the engine and your vehicle does not detect your intelligent access key inside your vehicle.
Run Power Active	Your vehicle is in the run ignition state.
Starting System Fault	There is a problem with your vehicle's starting system. See an authorized dealer for service.

Information Displays

Message	Action
Key Program Successful	You have successfully programmed an intelligent access key to the system.
Key Program Failure	You have failed to program an intelligent access key to the system.
Max Number of Keys Learned	You have programmed the maximum number of keys to the system.
Not Enough Keys Learned	You have not programmed enough keys to the system.
Key Battery Low Replace Soon	The key battery is low. Change the battery as soon as possible.
Engine On	Informs you that you are exiting your vehicle and the engine is on.

Lane Keeping System

Message	Action
Lane Keeping Sys. Malfunction Service Required	The system has malfunctioned. Contact an authorized dealer as soon as possible.
Front Camera Temporarily Not Available	The system has detected a condition that has caused the system to be temporarily unavailable.
Front Camera Low Visibility Clean Screen	The system has detected a condition that requires you to clean the windshield in order for it to operate properly.
Front Camera Malfunction Service Required	The system has malfunctioned. Contact an authorized dealer as soon as possible.
Keep Hands on Steering Wheel	The system requests you to keep your hands on the steering wheel.

Information Displays

Maintenance

Message	Action
LOW Engine Oil Pressure	Stop your vehicle as soon as safely possible and turn off the engine. Check the oil level. If the warning stays on or continues to come on with your engine running, contact an authorized dealer as soon as possible.
Change Engine Oil Soon	The engine oil life remaining is 10% or less. See Engine Oil Check (page 303).
Oil Change Required	The oil life left is at 0%. See Engine Oil Check (page 303).
Brake Fluid Level LOW	The brake fluid level is low, inspected the brake system immediately. See Brake Fluid Check (page 309).
Check Brake System	The brake system needs servicing. Stop your vehicle in a safe place. Contact an authorized dealer.
Transport / Factory Mode	Your vehicle is still in Transport or Factory mode. This may not allow some features to operate properly. See an authorized dealer.
See Manual	The powertrain needs service due to a powertrain malfunction.

MyKey

Message	Action
MyKey Not Created	You cannot program a MyKey.
MyKey Active Drive Safely	MyKey is active.
Speed Limited to XX MPH/km/h	When switching on your vehicle and MyKey is in use, displays that the MyKey speed limit is on.
Near Vehicle Top Speed	MyKey is in use and the MyKey speed limit is on and the vehicle speed is approaching 80 mph (130 km/h).
Vehicle at Top Speed of MyKey Setting	You have reached the speed limit set for your MyKey.
Check Speed Drive Safely	You have an active MyKey with a programmed set speed limit.
Buckle Up to Unmute Audio	Belt-Minder turns on with a MyKey in use.

Information Displays

Message	Action
AdvanceTrac On - MyKey Setting	With a MyKey in use, AdvanceTrac turns on.
Traction Control On - MyKey Setting	With a MyKey in use, traction control turns on.
MyKey Park Aid Cannot be Deactivated	With a MyKey in use, park aid is always on.
Lane Keeping Alert On MyKey Setting	With a MyKey in use, lane keeping alert turns on.

Off Road

Message	Action
Hill Descent Control- Active	Hill descent control mode is active.
Hill Descent Control- OFF	Hill descent control mode is inactive.
For Hill Descent Reduce Speed XX MPH/km/h or Less	Your vehicle speed requirement for off-road mode entry has not been met.
For Hill Descent Select Gear	You need to select a transmission gear for hill descent mode.
Hill Descent Driver Resume Control	Hill descent control mode is deactivated and you must resume control.
Hill Descent Control Fault	A hill descent system fault is present.
Hill Descent Control Off System Cooling	The hill descent system is cooling due to overuse.
Hill Descent Control-READY	The hill descent control system is ready.

Information Displays

Park Aid

Message	Action
Check Front Park Aid	The system has detected a condition that requires service. Contact an authorized dealer. See Parking Aid (page 201).
Check Rear Park Aid	The system has detected a condition that requires service. Contact an authorized dealer. See Parking Aid (page 201).
Front Park Aid On Off	Displays the park aid status.
Rear Park Aid On Off	Displays the park aid status.

Park Brake

Message	Action
To Release: Press Brake and Switch	The electric parking brake is set and a manual release is attempted without the brake pedal being pressed.
Park Brake Use Switch to Release	The electric park brake is set and an automatic release is attempted but cannot be performed. Perform a manual release.
Release Park Brake	The electric park brake is set and your vehicle speed exceeds 3mph (5km/h). Release park brake before continued driving.
Park Brake Not Applied	The electric park brake is not fully applied.
Park Brake Not Released	The electric park brake is not fully released.
Park Brake Maintenance Mode	The electric park brake system has been put into a special mode that is used to allow service of the rear brakes. Contact an authorized dealer.
Park Brake Limited Function Service Required	The electric park brake system has detected a condition that requires service. Some functionality may still be available. Contact an authorized dealer.
Park Brake Malfunction Service Now	The electric park brake system has detected a condition that requires service. Contact an authorized dealer.

Information Displays

Power Steering

Message	Action
Steering Fault Service Now	The power steering system has detected a condition that requires service. See an authorized dealer.
Steering Loss Stop Safely	The power steering system is not working. Stop your vehicle in a safe place. Contact an authorized dealer.
Steering Assist Fault Service Required	The power steering system has detected a condition within the power steering system or passive entry or passive start system requires service. Contact an authorized dealer.

Remote Start

Message	Action
To Drive: Press Brake and Gear Shift Button	A reminder to apply the brake and push the gearshift button to drive your vehicle after a remote start.

Seats

Message	Action
Memory Recall Not Permitted While Driving	A reminder that memory seats are not available while driving.
Memory X Saved	Shows where you have saved your memory setting.

Starting System

Message	Action
Press Brake to Start	A reminder to apply the brake when starting your vehicle .
Cranking Time Exceeded	The starter has exceeded its cranking time in attempting to start your vehicle.
Engine Start Pending Please Wait	The starter is attempting to start your vehicle.
Pending Start Cancelled	The system has cancelled the pending start.

Information Displays

Tire Pressure Monitoring System

Message	Action
LOW Tire Pressure	One or more tires on your vehicle has low tire pressure. See Tire Pressure Monitoring System (page 347).
Tire Pressure Monitor Fault	The tire pressure monitoring system is malfunctioning. If the warning stays on or continues to come on, contact an authorized dealer. See Tire Pressure Monitoring System (page 347).
Tire Pressure Sensor Fault	A tire pressure sensor is malfunctioning or your spare tire is in use. See Tire Pressure Monitoring System (page 347). If the warning stays on or continues to come on, contact an authorized dealer as soon as possible.

Trailer

Message	Action
Trailer Brake Gain = XZ.Z Output = BAR 1	The current gain setting for the trailer brake.
Trailer Brake Gain = XZ.Z No Trailer	The current gain setting for the trailer brake when a trailer is not connected.
Trailer Brake Module Fault	Faults sensed in the Integrated Trailer Brake Control Module followed by a single chime. See Towing a Trailer (page 249).
Trailer Connected	A correct trailer connection is sensed during a given ignition cycle.
Trailer Disconnected	A trailer connection becomes disconnected, either intentionally or unintentionally, and has been sensed during a given ignition cycle.
Trailer Sway Reduce Speed	The trailer sway control has detected trailer sway.
Trailer Wiring Fault	There are certain faults in your vehicle wiring and trailer wiring/brake system. See Towing a Trailer (page 249).
Trailer Left Turn Lamps Fault Check Lamps.	There is a fault with your trailer turn lamp. Check your lamp.

Information Displays

Message	Action
Trailer Right Turn Lamps Fault Check Lamps	There is a fault with your trailer turn lamp. Check your lamp.
Trailer Battery Not Charging See Manual	There is a fault with your trailer battery. See Towing a Trailer (page 249).
Trailer Lighting Module Fault See Manual	There is a fault with your vehicle trailer lighting module. See Towing a Trailer (page 249).

4WD

Message	Action
Check 4x4	A 4X4 system fault is present. See Using Four-Wheel Drive (page 180).
4x4 Shift in Progress	The 4X4 system is making a shift.
For 4x4 Low Shift to N	When your vehicle is at a stop and you need to shift into Neutral before you select 4X4 LOW.
For 4x4 Low Slow to 3 MPH	When your vehicle is moving and you need to reduce your speed to select 4X4 LOW.
To Exit 4x4 LOW Shift to N	You select 2WD while your vehicle is at a stop in 4X4 LOW and you need to shift into Neutral.
To Exit 4x4 LOW Slow to 3 MPH	You select 2WD while your vehicle is operating in 4X4 LOW and you need to reduce your speed.
Shift Delayed Pull Forward	May display when there is a Transfer case gear tooth blockage while shifting to or from 4L or to the neutral state.
4x4 Temporarily Disabled	A 4X4 system fault is present and the system is temporarily disabled. See Using Four-Wheel Drive (page 180).
4x4 Auto Restored	The 4X4 system has been restored.
4x4 Temporarily Locked	A 4X4 system fault is present and the system is temporarily locked. See Using Four-Wheel Drive (page 180).

Climate Control

MANUAL CLIMATE CONTROL

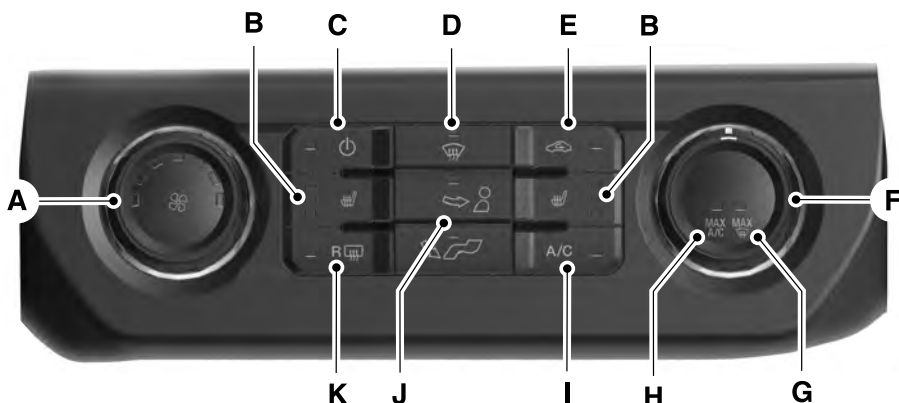

E217932

- A **Fan speed control:** Adjust the volume of air circulated in the vehicle.
- B **Heated seats:** Press to switch the heated seats on and off. See **Heated Seats** (page 146).
- C **Power:** Press to switch the system on and off. When the system is off, it prevents outside air from entering the vehicle.
- D **Defrost:** Select to distribute air through the windshield air vents. Air distribution to the instrument panel and footwell vents turns off. You can also use this setting to defrost and clear the windshield of a thin covering of ice.
- E **Recirculated air:** Press to switch between outside air and recirculated air. The air currently in the passenger compartment recirculates. This can reduce the time needed to cool the interior and reduce unwanted odors from entering your vehicle.
- F **Temperature control:** Controls the temperature of the airflow in your vehicle.

Climate Control

- G **MAX Defrost:** Adjust to switch on defrost. Outside air flows through the windshield vents, air conditioning automatically turns on. You can also use this setting to defrost and clear the windshield of a thin covering of ice.
Note: To prevent window fogging, you cannot select recirculated air when maximum defrost is on.
- H **MAX A/C:** Adjust for maximum cooling. Recirculated air flows through the instrument panel vents and air conditioning automatically turns on.
- I **A/C:** Press to switch the air conditioning on or off. Air conditioning cools your vehicle using outside air. To improve the time to reach a comfortable temperature in hot weather, drive with the windows open until you feel cold air through the air vents.
Note: In certain conditions (for example, maximum defrost), the air conditioning may continue to operate even though the air conditioning is switched off.
- J **Air distribution control:** Press to switch airflow from the windshield, instrument panel, or footwell vents on or off. You can distribute air through any combination of these vents.
Note: At least one of these buttons remain on while the system is on.
- K **Heated rear window:** Press to switch the heated rear window on and off. See **Heated Windows and Mirrors** (page 137).

Climate Control

AUTOMATIC CLIMATE CONTROL

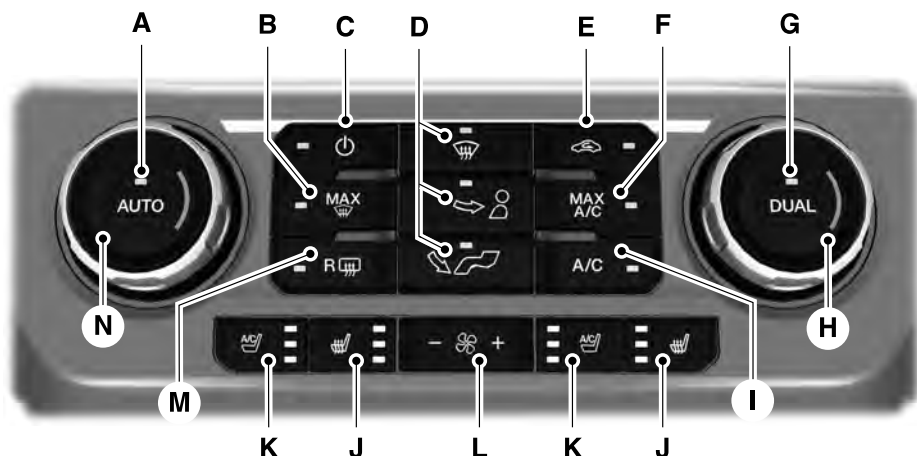

E217905

- A **AUTO:** Press to switch on automatic operation. Adjust to select the desired temperature. Fan speed, air distribution, air conditioning operation, and outside or recirculated air are automatically adjusted to heat or cool the vehicle to maintain the desired temperature. You can also switch off dual zone mode by pressing and holding for more than two seconds.
- B **MAX Defrost:** Press to switch on defrost. Outside air flows through the windshield vents, air conditioning automatically turns on, and fan automatically adjusts to the highest speed. You can also use this setting to defrost and clear the windshield of a thin covering of ice. The heated rear window also automatically turns on when you select maximum defrost.
Note: To prevent window fogging, you cannot select recirculated air when maximum defrost is on.
- C **Power:** Press to switch the system on and off. When the system is off, it prevents outside air from entering the vehicle.
- D **Air distribution control:** Press to switch airflow from the windshield, instrument panel, or footwell vents on or off. You can distribute air through any combination of these vents.

Climate Control

- E Recirculated air:** Press to switch between outside air and recirculated air. The air currently in the passenger compartment recirculates. This can reduce the time needed to cool the interior and reduce unwanted odors from entering your vehicle.
- Note:** Recirculated air may also turn on and off automatically in instrument panel or instrument panel and floor airflow modes during hot weather to improve cooling efficiency.
- F MAX A/C:** Press for maximum cooling. Recirculated air flows through the instrument panel vents, air conditioning automatically turns on, and the fan automatically adjusts to the highest speed.
- G DUAL:** Press to switch separate passenger side temperature control off and on. When dual zone is off, passenger temperature settings remain the same as the driver settings.
- H Passenger temperature control:** Adjust the temperature setting on the passenger side.
- I A/C:** Press to switch the air conditioning on or off. Air conditioning cools your vehicle using outside air. To improve the time to reach a comfortable temperature in hot weather, drive with the windows open until you feel cold air through the air vents.
- Note:** In certain conditions (for example, maximum defrost), the air conditioning may continue to operate even though the air conditioning is switched off.
- J Heated seats:** Press to switch the heated seats on and off. See **Heated Seats** (page 146).
- K Climate controlled seats:** Press to switch the climate controlled seats on and off. See **Climate Controlled Seats** (page 147).
- L Fan speed control:** Adjust the volume of air circulated in the vehicle.
- M Heated rear window:** Press to switch the heated rear window on and off. See **Heated Windows and Mirrors** (page 137).
- N Driver temperature control:** Adjust the temperature setting on the driver side.

Note: You may feel a small amount of air from the footwell air vents regardless of the air distribution setting.

Note: To reduce humidity build-up inside your vehicle, do not drive with the system switched off or with recirculated air always switched on.

Note: Do not place objects under the front seats as this may interfere with the airflow to the rear seats.

HINTS ON CONTROLLING THE INTERIOR CLIMATE

General Hints

WARNING



Prolonged use of recirculated air may cause the windows to fog up. If the windows fog up, follow the settings for demisting the windshield.

Climate Control

Note: Remove any snow, ice or leaves from the air intake area at the base of the windshield.

Note: To improve the time to reach a comfortable temperature in hot weather, drive with the windows open until you feel cold air through the air vents.

Manual Climate Control

Note: To reduce fogging of the windshield during humid weather, adjust the air distribution control to the windshield air vents position.

Automatic Climate Control

Note: Adjusting the settings when your vehicle interior is extremely hot or cold is not necessary. The system automatically adjusts to heat or cool the interior to your selected temperature as quickly as possible. For the system to function efficiently, the instrument panel and side air vents should be fully open.

Note: If you select **AUTO** during cold outside temperatures, the system directs airflow to the windshield and side window vents. In addition, the fan may run at a slower speed until the engine warms up.

Note: If you select **AUTO** during hot outside temperatures, or when the inside of the vehicle is hot, the system automatically uses recirculated air to maximize interior cooling. When the interior reaches the selected temperature, the system automatically switches to using outside air.

Heating the Interior Quickly

	Vehicle with manual climate control	Vehicle with automatic climate control
1	Adjust the fan speed to a high speed setting.	Press the AUTO button.
2	Adjust the temperature control to the full heat setting.	Adjust the temperature control to the desired setting.
3	Select the footwell air vents using the air distribution buttons.	

Climate Control

Recommended Settings for Heating

	Vehicle with manual climate control	Vehicle with automatic climate control
1	Adjust the fan speed to the center setting.	Press the AUTO button.
2	Adjust the temperature control to the midway point of the hot settings.	Adjust the temperature control to the desired setting. Use 72°F (22°C) as a starting point, then adjust the setting as necessary.
3	Select the footwell air vents using the air distribution buttons.	

Cooling the Interior Quickly

	Vehicle with manual climate control	Vehicle with automatic climate control
1	Adjust the temperature control to the MAX A/C position.	Press the MAX A/C button.
2	Drive with the windows fully open until you feel cold air through the air vents.	

Recommended Settings for Cooling

	Vehicle with manual climate control	Vehicle with automatic climate control
1	Adjust the fan speed to the center setting.	Press the AUTO button.
2	Adjust the temperature control to the midway point of the cold settings.	Adjust the temperature control to the desired setting. Use 72°F (22°C) as a starting point, then adjust the setting as necessary.
3	Select the instrument panel air vents using the air distribution buttons.	

Climate Control

Side Window Defogging in Cold Weather

	Vehicle with manual climate control	Vehicle with automatic climate control
1	Select the windshield air vents using the air distribution buttons.	Press the defrost button.
2	Press the A/C button if the indicator is off.	Adjust the temperature control to the desired setting. Use 72°F (22°C) as a starting point, then adjust the setting as necessary.
3	Adjust the temperature control to the desired setting.	
4	Adjust the fan speed to a high speed setting.	

HEATED WINDOWS AND MIRRORS (If Equipped)

Heated Rear Window

Note: Make sure the engine is running before operating the heated windows.



Press the button to clear the heated rear window of thin ice and fog. The heated rear window will automatically turn off after a short period of time. Start the engine before you switch the heated rear window on.

Note: Do not use razor blades or other sharp objects to clean or remove decals from the inside of the heated rear window. The vehicle warranty does not cover damage caused to the heated rear window grid lines.

Heated Exterior Mirror (If Equipped)

When you switch the heated rear window on, the heated exterior mirrors will automatically turn on.

Note: Do not remove ice from the mirrors with a scraper or adjust the mirror glass when it is frozen in place.

Note: Do not clean the mirror housing or glass with harsh abrasives, fuel or other petroleum-based cleaning products.

CABIN AIR FILTER

Your vehicle is equipped with a cabin air filter, which gives you and your passengers the following benefits:

- It improves your driving comfort by reducing particle concentration.
- It improves the interior compartment cleanliness.
- It protects the climate control components from particle deposits.

You can locate the cabin air filter behind the glove box.

Note: Make sure you have a cabin air filter installed at all times. This prevents foreign objects from entering the system. Running the system without a filter in place could result in degradation or damage to the system.

Replace the filter at regular intervals. See **Scheduled Maintenance** (page 501).

Climate Control

For additional cabin air filter information, or to replace the filter, see an authorized dealer.

REMOTE START (If Equipped)

The remote start feature allows you to pre-condition the interior of your vehicle. The climate control system works to achieve comfort according to your previous settings.

Note: *You cannot adjust the system during remote start operation.*

Turn the ignition on to return the system to its previous settings. You can now make adjustments normally, but you need to turn certain vehicle-dependent features back on, such as:

- Heated seats.
- Cooled seats.
- Heated steering wheel.
- Heated mirrors.
- Heated rear window.

You can adjust the default remote start settings using the information display controls. See **Information Displays** (page 103).

Automatic Settings

In hot weather, the system is set to 72°F (22°C). The cooled seats are set to high (if available, and selected to AUTO in the information display).

In moderate weather, the system either heats or cools (based on previous settings). The rear defroster, heated mirrors and heated seats do not automatically turn on.

In cold weather, the system is set to 72°F (22°C). The heated seats are set to high (if available, and selected to AUTO in the information display). The rear defroster and heated mirrors automatically turn on.

Seats

SITTING IN THE CORRECT POSITION

WARNINGS



Sitting improperly, out of position or with the seatback reclined too far can take weight off the seat cushion and affect the decision of the passenger sensing system, resulting in serious injury or death in the event of a crash. Always sit upright against your seat back, with your feet on the floor.



Do not recline the seatback as this can cause the occupant to slide under the safety belt, resulting in serious injury in the event of a crash.



Do not place objects higher than the seatback to reduce the risk of serious injury in the event of a crash or during heavy braking.

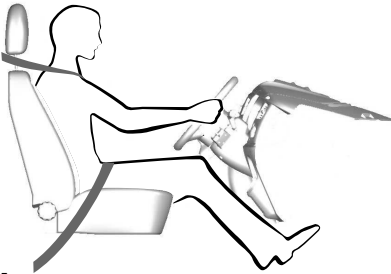

E68595

When you use them properly, the seat, head restraint, safety belt and airbags will provide optimum protection in the event of a crash.

We recommend that you follow these guidelines:

- Sit in an upright position with the base of your spine as far back as possible.
- Do not recline the seatback more than 30 degrees.
- Adjust the head restraint so that the top of it is level with the top of your head and as far forward as possible. Make sure that you remain comfortable.
- Keep sufficient distance between yourself and the steering wheel. We recommend a minimum of 10 in (25 cm) between your breastbone and the airbag cover.
- Hold the steering wheel with your arms slightly bent.
- Bend your legs slightly so that you can press the pedals fully.
- Position the shoulder strap of the safety belt over the center of your shoulder and position the lap strap tightly across your hips.

Make sure that your driving position is comfortable and that you can maintain full control of your vehicle.

HEAD RESTRAINTS

WARNINGS



Fully adjust the head restraint before you sit in or operate your vehicle. This will help minimize the risk of neck injury in the event of a crash. Do not adjust the head restraint when your vehicle is moving.



The head restraint is a safety device. Whenever possible it should be installed and properly adjusted when the seat is occupied. An improperly adjusted head restraint may not adequately protect an occupant during an impact from the rear.

Seats

WARNINGS



Install the head restraint properly to help minimize the risk of neck injury in the event of a crash.

Note: Adjust the seatback to an upright driving position before adjusting the head restraint. Adjust the head restraint so that the top of it is level with the top of your head and as far forward as possible. Make sure that you remain comfortable. If you are extremely tall, adjust the head restraint to its highest position.

Front Seat Head Restraint

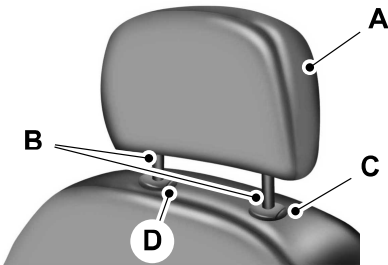

E138642

Rear Seat Outboard Head Restraints

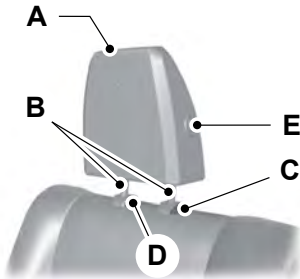

E166700

Rear Seat Center Head Restraint

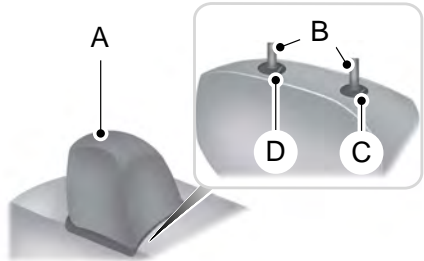

E166701

The head restraints consist of:

- A An energy absorbing head restraint.
- B Two steel stems.
- C Guide sleeve adjust and release button.
- D Guide sleeve unlock and remove button.
- E Fold button (rear seat outboard only).

Adjusting the Head Restraint

Raising the Head Restraint

Pull the head restraint up.

Lowering the Head Restraint

1. Press and hold button C.
2. Push the head restraint down.

Removing the Head Restraint

1. Pull up the head restraint until it reaches the highest adjustment position.
2. Press and hold buttons C and D.
3. Pull up the head restraint.

Seats

Note: For rear seat outboard seats, you can fold the head restraint forward for easier removal.

Installing the Head Restraint

Align the steel stems into the guide sleeves and push the head restraint down until it locks.

Folding the Head Restraint

Note: The rear seat outboard head restraints may fold forward for improved visibility.

1. Press and hold button E.
2. Pull it back up to reset.

Front Seat Center Head Restraint

Your vehicle may be equipped with a front row center head restraint that you cannot adjust or remove.

Tilting Head Restraints (If Equipped)

The front head restraints tilt for extra comfort. To tilt the head restraint, do the following:



E144727

1. Adjust the seatback to an upright driving or riding position.

2. Pivot the head restraint forward toward your head to the desired position.

After the head restraint reaches the forward-most tilt position, pivot it forward again to release it to the rearward, untilted position.

Note: Do not attempt to force the head restraint backward after it is tilted. Instead, continue tilting it forward until the head restraint releases to the upright position.

MANUAL SEATS

WARNING



Do not adjust the driver's seat or seatback when your vehicle is moving.

Moving the Seat Backward and Forward



E175314

Seats

Recline Adjustment



E175315

Manual Lumbar (If Equipped)





E166702

The lumbar support control is located on the outboard side of the seat. Turn the control to adjust your support.

POWER SEATS (If Equipped)

WARNINGS

-  Do not adjust the driver seat or seatback when your vehicle is moving. Adjusting your seatback while the vehicle is in motion may cause loss of control of the vehicle.
-  Do not place cargo or any objects behind the seatback before returning it to the original position.

Seats



E176038

Power Lumbar (If Equipped)



E176039

Multi-Contour Front Seats With Active Motion (If Equipped)

Note: The massage system will turn off after 20 minutes.

Note: The engine must be running or the vehicle must be in accessory mode to activate the seats.

Note: Allow a few seconds for any selection to activate. The seatback and cushion massage cannot function at the same time.

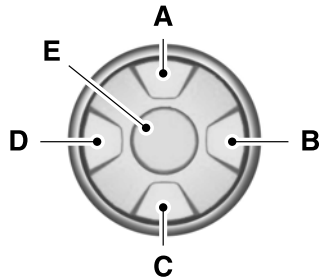

E156301

Seats

	Massage mode	Lumbar and bolster mode
A	Back massage intensity adjustment	Upper lumbar
B	Massage intensity decrease and off*	Lumbar decrease
C	Cushion massage intensity adjustment	Lower lumbar**
D	Massage intensity increase	Lumbar increase
E	On and off	-

*The massage feature will default to an alternating massage mode with back massage intensity adjustment. The lumbar and bolster feature will default to the middle lumbar mode.

**Press C a second time to adjust the back bolster. Press C a third time to adjust the cushion bolster.

You can also adjust this feature through the touchscreen. When switched on, the system displays directions for you to adjust the lumbar settings in your seat or to set the massage function. To access and make adjustments to the lumbar setting:

1. Press the Menu Settings icon > Vehicle > Multi-contour Seat.
2. Choose the desired seat to adjust.
3. Press the + or - to adjust the lumbar intensity.

To access and make adjustments to the massage setting:

1. Press the Menu Settings icon > Vehicle > Multi-contour Seat.
2. Choose the desired seat to adjust.
3. Press Off, Lo or Hi.

MEMORY FUNCTION (If Equipped)

WARNINGS



Before activating the seat memory, make sure that the area immediately surrounding the seat is clear of obstructions and that all occupants are clear of moving parts.



Do not use the memory function when your vehicle is moving.

This function automatically recalls the position of these features:

- Driver seat.
- Power mirrors.
- Optional power steering column.
- Optional power adjustable pedals.

The memory control is on the driver door.

Seats



E142554

Saving a PreSet Position

1. Switch the ignition on.
2. Adjust the seat, exterior mirrors, power adjustable pedals and power steering column to your desired position.
3. Press and hold the desired preset button until you hear a single tone.

Note: A confirmation that you saved a memory preset appears in the information display.

You can save up to three preset memory positions. You can save a memory preset at any time.

Recalling a PreSet Position

Press and release the preset button associated with your desired driving position. The seat, mirrors, pedals and steering column move to the position stored for that preset.

Note: You can only recall a preset memory position when the ignition is off, or when you place the transmission in park (P) or neutral (N) if the ignition is on.

Note: Press any seat or mirror adjustment switch (or any memory button) during a memory recall to cancel the operation.

You can also recall a preset memory position by:

- Pressing the unlock button on your intelligent access key fob if you linked it to a preset position.
- Unlocking the intelligent driver door handle if a linked key fob is present.
- Entering a personal entry code on the Securicode keypad. See **Keyless Entry** (page 64).

Note: Using a linked key fob to recall your memory position when the ignition is off will move the seat and steering column to the Easy Entry position.

Linking a PreSet Position to your Remote Control or Intelligent Access Key

Your vehicle can save the preset memory positions for up to three remote controls or intelligent access (IA) keys.

1. With the ignition on, move the memory features to the position you desire.
2. Press and hold the desired preset button for about five seconds. A tone sounds after about two seconds. Continue holding until you hear a second tone.
3. Within three seconds, press the lock button on the remote control you are linking.

To unlink a remote control, follow the same procedure – except in Step 3, press the unlock button on the remote control.

Easy Entry and Exit Feature

If you enable the easy entry and exit feature, it automatically moves the driver seat position rearward up to two inches (five centimeters) when you switch the ignition off. The driver seat returns to the previous position when you switch the ignition on.

Seats

You can enable or disable this feature in the information display. See **Information Displays** (page 103).

REAR SEATS

Folding Up the Rear Seat Cushion

The rear seat has a split 60/40 cushion. You can flip each seat cushion up into a vertical storage position.



E181250

Rotate the seat cushion up until it locks into the vertical storage position.

Returning the Seat to the Seating Position

WARNING



Make sure that cargo or any objects are not trapped underneath the seat cushion before returning the seat cushion to its original position, and that the seat cushion locks into place. Failure to do so may prevent the seat from operating properly in the event of a crash, which could increase the risk of serious injury.



E166704

Pull the control on the bottom of the seat cushion to release the seat cushion from the storage position.

HEATED SEATS (If Equipped)

WARNING



People who are unable to feel pain to their skin because of advanced age, chronic illness, diabetes, spinal cord injury, medication, alcohol use, exhaustion or other physical conditions, must exercise care when using the heated seat. The heated seat may cause burns even at low temperatures, especially if used for long periods of time. Do not place anything on the seat that insulates against heat, such as a blanket or cushion. This may cause the heated seat to overheat. Do not puncture the seat with pins, needles or other pointed objects. This may damage the heating element which may cause the heated seat to overheat. An overheated seat may cause serious personal injury.

Seats

Do not do the following:

- Place heavy objects on the seat.
- Operate the heated seat if water or any other liquid spills on the seat. Allow the seat to dry thoroughly.
- Operate the heated seats unless the engine is running. Doing so can cause the battery to lose charge.



E146322

Press the heated seat symbol to cycle through the various heat settings and off. More indicator lights indicate warmer settings.

Rear Heated Seats (If Equipped)

WARNING



People who are unable to feel pain to the skin because of advanced age, chronic illness, diabetes, spinal cord injury, medication, alcohol use, exhaustion, or other physical conditions, must exercise care when using the seat heater. The seat heater may cause burns even at low temperatures, especially if used for long periods of time. Do not place anything on the seat that insulates against heat, such as a blanket or cushion, because this may cause the seat heater to overheat. Do not puncture the seat with pins, needles, or other pointed objects because this may damage the heating element which may cause the seat heater to overheat. An overheated seat may cause serious personal injury.

Do not do the following:

- Place heavy objects on the seat.
- Operate the heated seat if water or any other liquid spills on the seat. Allow the seat to dry thoroughly.
- Operate the heated seats unless the engine is running. Doing so can cause the battery to lose charge.

The rear seat heat controls are located on the rear of the center console.



E146322

Press the heated seat symbol to cycle through the various heat settings and off. More indicator lights indicate warmer settings.

The heated seat module resets at every ignition run cycle. While the ignition is in the on position, press the heated seat switch to enable heating mode. When activated, they turn off automatically when you switch off the engine.

CLIMATE CONTROLLED SEATS

(If Equipped)

Heated Seats

Seats

WARNING



Persons who are unable to feel pain to the skin because of advanced age, chronic illness, diabetes, spinal cord injury, medication, alcohol use, exhaustion, or other physical conditions, must exercise care when using the seat heater. The seat heater may cause burns even at low temperatures, especially if used for long periods of time. Do not place anything on the seat that insulates against heat, such as a blanket or cushion, because this may cause the seat heater to overheat. Do not puncture the seat with pins, needles, or other pointed objects because this may damage the heating element which may cause the seat heater to overheat. An overheated seat may cause serious personal injury.

Note: Do not do the following:

- Place heavy objects on the seat.
- Operate the seat heater if water or any other liquid spills on the seat. Allow the seat to dry thoroughly.
- Operate the heated seats unless the engine is running. Doing so can cause the battery to lose charge.



E146322

Touch the heated seat symbol to cycle through the various heat settings and off. More indicator lights indicate warmer settings.

Cooled Seats

The cooled seats only function when the engine is running.



E146309

To operate the cooled seats:

Touch the cooled seat symbol to cycle through the various cooling settings and off. More indicator lights indicate cooler settings.

If the engine falls below 350 RPM while the cooled seats are on, the feature turns itself off. You need to reactivate it.

Climate controlled seat air filter replacement

Your vehicle is equipped with lifetime air filters that are integrated with the seats. Regular maintenance or replacement is not needed.

Seats

FRONT SEAT ARMREST (If Equipped)



E175382

Press the release control to move the front seat armrest up or down.

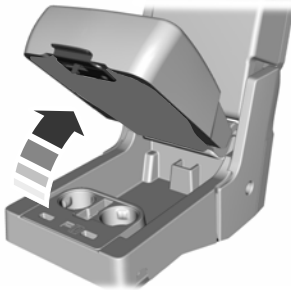

E184821

Lift the latch to open the lid and gain access to the optional storage compartment under the center seat cushion.

The cupholder is located inside the front seat armrest. You can also flip the cupholder so that it faces forward. See **Center Console** (page 156).

REAR SEAT ARMREST (If Equipped)



E181222

Pull the strap located on the center seatback to access the armrest and cupholders.

The cupholders are located inside the rear seat armrest. To open the cupholders:

1. Push in gently on the center of the plastic panel on the front edge of the armrest. The cupholders will partially open.
2. Pull the cupholder fully open before using.

Universal Garage Door Opener (If Equipped)

HomeLink Wireless Control System

WARNINGS



Make sure that the garage door and security device are free from obstruction when you are programming. Do not program the system with the vehicle in the garage.



Do not use the system with any garage door opener that does not have the safety stop and reverse feature as required by U.S. Federal Safety Standards (this includes any garage door opener manufactured before April 1, 1982). A garage door opener which cannot detect an object, signaling the door to stop and reverse, does not meet current federal safety standards. Using a garage door opener without these features increases the risk of serious injury or death.

Note: Make sure you keep the original remote control transmitter for use in other vehicles as well as for future system programming.

Note: We recommend that upon the sale or lease termination of your vehicle, you erase the programmed function buttons for security reasons. See **Erasing the Function Button Codes** later in this section.

Note: You can program a maximum of three devices. To change or replace any of the three devices after it has been initially programmed, you must first erase the current settings. See **Erasing the Function Button Codes**.



E188211

The universal garage door opener replaces the common hand-held garage door opener with a three-button transmitter integrated into the driver's sun visor.

The system includes two primary features, a garage door opener and a platform for remote activation of devices within the home. You can program garage doors as well as entry gate operators, security systems, entry door locks and home or office lighting.

Additional system information can be found online at www.homelink.com, www.youtube.com/user/HomeLinkGentex or by calling the toll-free help line at 1-800-355-3515.

In-Vehicle Programming

This process is to program your in-vehicle HomeLink function button with your hand-held transmitter.

Note: The programming steps below assume you will be programming HomeLink that was not previously programmed. If your HomeLink was previously programmed, you may need to erase your HomeLink buttons. See **Erasing the Function Button Codes**.

Note: Put a new battery in the hand-held transmitter. This helps ensure quicker training and accurate transmission of the radio-frequency signal.

Universal Garage Door Opener (If Equipped)

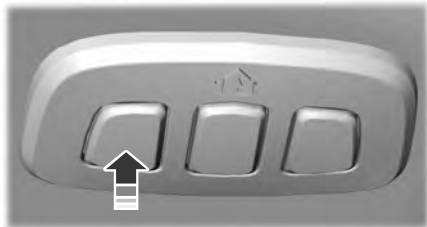

E188212

1. With your vehicle parked outside of the garage, switch your ignition to the **on** position, but do not start your vehicle.
2. Press and release the function button that you would like to program.
3. Hold your hand-held garage door transmitter 1–3 in (2–8 cm) away from the HomeLink button you want to program.
4. Press and hold the hand-held transmitter button you want to program while watching the indicator light on HomeLink. Continue to hold the hand-held button until the HomeLink indicator light flashes rapidly or is continuously on.

Note: You may need to use a different method if you live in Canada or have difficulties programming your gate operator or garage door opener. See **Gate Operator / Canadian Programming**.

5. Press and hold the HomeLink button you programmed for two seconds, then release. You may need to do this twice to activate the door. If your garage door does not operate, watch the HomeLink indicator light.

If the indicator light stays on, the programming is complete. Your device should activate when the HomeLink button is pressed and released.

If the indicator light flashes rapidly, press and hold for two seconds and release the programmed HomeLink button. Repeat the "press/hold/release" sequence up to three times to complete the programming process. If your device still does not operate, you must program your garage door. See **Programming Your Garage Door Opener Motor**.

To program additional buttons, repeat Steps 1 – 4.

For questions or comments, please contact HomeLink at www.homelink.com, www.youtube.com/user/HomeLinkGentex or by calling the toll-free help line at 1-800-355-3515.

Programming Your Garage Door Opener Motor

Note: You may need a ladder to reach the unit and you may need to remove the cover or lamp lens on your garage door opener.



E142659

1. Press the learn button on the garage door opener motor and then you have 30 seconds to complete the next two steps.
2. Return to your vehicle.

Universal Garage Door Opener (If Equipped)



E188212

3. Press and hold the function button you want to program for 2 seconds, then release. Repeat this step. Depending on your brand of garage door opener, you may need to repeat this sequence a third time.

Gate Operator / Canadian Programming

Canadian radio-frequency laws require transmitter signals to “time-out” (or quit) after several seconds of transmission – which may not be long enough for HomeLink to pick up the signal during programming. Similar to this Canadian law, some U.S. gate operators are designed to “time-out” in the same manner.

Note: *If programming a garage door opener or gate operator, it is advised to unplug the device during the “cycling” process to prevent possible overheating.*

1. Press and release, **every two seconds**, your hand-held transmitter until the HomeLink indicator light changes to a rapidly blinking or continuously on light.
2. Release the hand-held transmitter button.
3. Continue programming HomeLink. See **In-Vehicle Programming, Step 4.**

Erasing the Function Button Codes

Note: *You cannot erase individual buttons.*

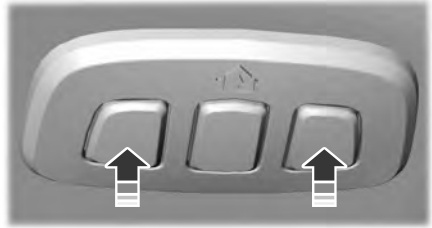

E188213

1. Press and hold the outer two function buttons simultaneously for approximately 10 seconds until the indicator light above the buttons flashes rapidly.
2. When the indicator light flashes, release the buttons. You erased the codes for all buttons.

Reprogramming a Single Button

To program a device to a previously trained button, follow these steps:

1. Press and hold the desired button. Do NOT release the button.
2. The indicator light begins to flash after 20 seconds. Without releasing the button, follow Step 1 in the Programming section.

For questions or comments, contact HomeLink at www.homelink.com, www.youtube.com/user/HomeLinkGentex or by calling the toll-free help line at 1-800-355-3515.

Universal Garage Door Opener (If Equipped)

FCC and RSS-210 Industry Canada Compliance

This device complies with Part 15 of the FCC Rules and with RSS-210 of Industry Canada. Operation is subject to the following two conditions: (1) this device may not cause harmful interference, and (2) this device must accept any interference received, including interference that may cause undesired operation.

Note: *Changes or modifications to your device not expressly approved by the party responsible for compliance can void the user's authority to operate the equipment.*

This equipment complies with FCC radiation exposure limits set forth for an uncontrolled environment. End Users must follow the specific operating instructions for satisfying RF exposure compliance. This transmitter must be at least 8 in (20 cm) from the user and must not be co-located or operating in conjunction with any other antenna or transmitter.

The term "IC:" before the certification/registration number only signifies that Industry Canada technical specifications were met.

Auxiliary Power Points

12 Volt DC Power Point

WARNING



Do not plug optional electrical accessories into the cigar lighter socket (if equipped). Improper use of the lighter can cause damage not covered by your warranty, and can result in fire or serious injury.

Note: *If used when the engine is not running, the battery can discharge. There may be insufficient power to restart your engine.*

Note: *Do not insert objects other than an accessory plug into the power point. This damages the outlet and blows the fuse.*

Note: *Do not hang any type of accessory or accessory bracket from the plug.*

Note: *Do not use the power point over the vehicle capacity of 12 volt DC 180 watts or a fuse may blow.*

Note: *Do not use the power point for operating a cigar lighter element.*

Note: *Improper use of the power point can cause damage not covered by your warranty.*

Note: *Always keep the power point caps closed when not in use.*

Run the engine for full capacity use of the power point. To prevent the battery from being discharged:

- Do not use the power point longer than necessary when the engine is not running.
- Do not leave devices plugged in overnight or when the vehicle is parked for extended periods.

Locations

Power points may be in the following locations:

- On the instrument panel.
- In the front of the center console.
- In the 20% seat bin.
- In the center console storage bin.
- On the rear of the center console.

110 Volt - 400 Watt Capacity AC Power Outlet

WARNING



Do not keep electrical devices plugged in the power outlet when the devices are not in use. Do not use any extension cord with the 110 volt AC power outlet, since it will defeat the safety protection design. Do not use a single power outlet to power multiple devices. It may cause the power outlet to exceed the 400 watt load limit and overload, resulting in fire or serious injury.



E191617

Auxiliary Power Points

When the indicator light, located on the power outlet, is:

- On and the light is solid — the power outlet is available or the plugged in device is within the power range and does not exceed the outlet's power limits.
- Three flashes and off — the power outlet is overloading.
- Off — the power outlet power supply is off; ignition is not on.
- Constant flashing — the power outlet is in fault mode, and requires you to restart your vehicle.

The power outlet temporarily turns off power when in fault mode if the device exceeds the 400 watt limit. Unplug your device and switch the ignition off. Switch the ignition back on, but do not plug your device back in. Let the system cool off and switch the ignition off to reset the fault mode. Switch the ignition back on and make sure the indicator light remains on.

You can use the 400 watt power outlet for these types of electric devices:

- Electric hand drills.
- Rechargeable power tools.
- Video games.
- Laptops.
- Television screens.

You should not use the 400 watt power outlet for these types of electric devices:

- Cathode ray tube type televisions.
- Motor loads, for example vacuum cleaners, electric saws and other electric power tools, or compressor-driven refrigerators.

- Measuring devices which process precise data, for example medical equipment or measuring equipment.
- Other appliances requiring an extremely stable power supply, for example microcomputer-controlled electric blankets or touch sensor lamps.

Note: *This feature works only when the vehicle is running.*

Note: *This feature has a maximum output of 400 watts when the vehicle is in park (P).*

Note: *While in drive (D), the maximum outlet output is 300 watts.*

Note: *When powering electric devices that require more than 10 watts in vehicles equipped with keyless start, the vehicle must remain running. It does not allow you to switch the ignition off or switch the ignition to accessory mode.*

Storage Compartments

CENTER CONSOLE (If Equipped)

Stow items in the cup holder carefully as items may become loose during hard braking, acceleration or crashes, including hot drinks which may spill.

In vehicles with a 40-20-40 split-bench seat, the cup holders are inside of the folding console.

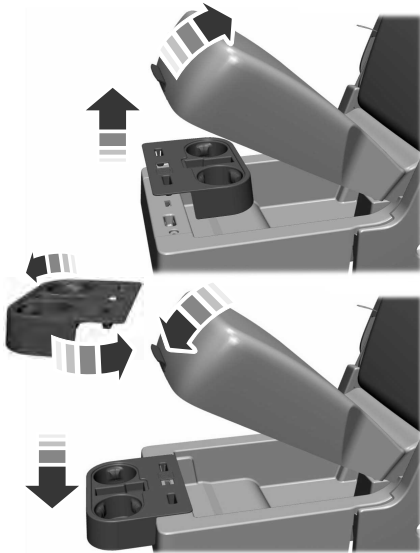

E185121

To use the cup holders:

1. Lift the console lid up to open.
2. Lift the cup holders up and rotate them outward.
3. Close the console.

Vehicles with a console-mounted shifter feature cup holders molded into the console.

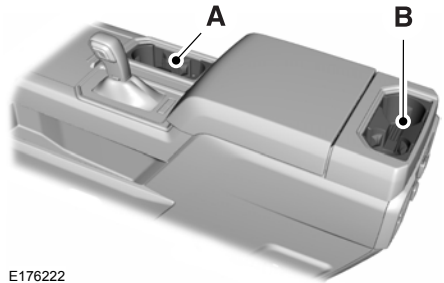

E176222

- A. Front cup holders.
B. Rear cup holders.

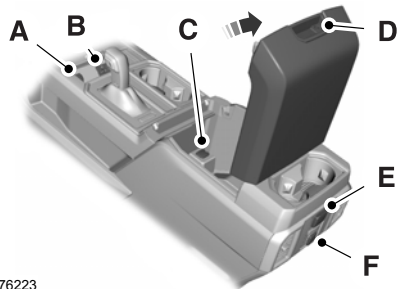

E176223

Available console features include:

- A. 12 volt DC power point.
B. One of the following:
- USB ports and SD card slot.
 - Audio input jack and USB port.
 - Audio input jack.
- C. 12-volt power point.
D. Locking storage compartment with hanging file folder supports and room for a laptop computer.
E. 110 volt AC power point.
F. 12 volt DC power point.

Storage Compartments

OVERHEAD CONSOLE (If Equipped)

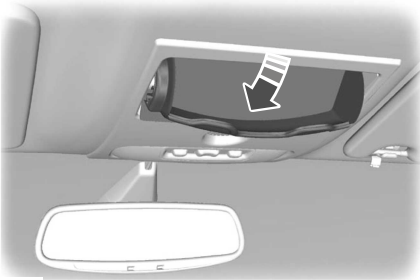

E75193

Press near the rear edge of the door to open it.

Starting and Stopping the Engine

GENERAL INFORMATION

WARNINGS



Extended idling at high engine speeds can produce very high temperatures in the engine and exhaust system, creating the risk of fire or other damage.



Do not park, idle or drive your vehicle on dry grass or other dry ground cover. The emission system heats up the engine compartment and exhaust system, creating the risk of fire.



Do not start the engine in a closed garage or in other enclosed areas. Exhaust fumes can be toxic. Always open the garage door before you start the engine.



If you smell exhaust fumes inside your vehicle, have your vehicle checked by an authorized dealer immediately. Do not drive your vehicle if you smell exhaust fumes.

If you disconnect the battery, your vehicle may exhibit some unusual driving characteristics for approximately 5 miles (8 kilometers) after you reconnect it. This is because the engine management system must realign itself with the engine. You can disregard any unusual driving characteristics during this period.

The powertrain control system meets all Canadian interference-causing equipment standard requirements regulating the impulse electrical field or radio noise.

When you start the engine, avoid pressing the accelerator pedal before and during operation. Only use the accelerator pedal when you have difficulty starting the engine.

IGNITION SWITCH

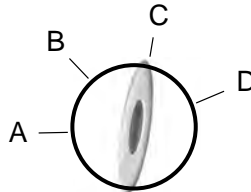

E163165

A (off) - The ignition is off.

Note: When you switch the ignition off and leave your vehicle, do not leave your key in the ignition. This could cause your vehicle battery to lose charge.

B (accessory) - Allows the electrical accessories, such as the radio, to operate while the engine is not running.

Note: Do not leave the ignition key in this position for too long. This could cause your vehicle battery to lose charge.

C (on) - All electrical circuits are operational and the warning lamps and indicators illuminate.

D (start) - Cranks the engine.

KEYLESS STARTING

Note: The keyless starting system may not function if the key is close to metal objects or electronic devices such as cellular phones.

Note: A valid key must be located inside your vehicle to switch the ignition on and start the engine.

Starting and Stopping the Engine

Ignition Modes



E144447

The keyless starting system has three modes:

Off: Turns the ignition off.

- Without applying the brake pedal, press and release the button once when the ignition is in the on mode, or when the engine is running but the vehicle is not moving.

On: All electrical circuits are operational and the warning lamps and indicators illuminate.

- Without applying the brake pedal, press and release the button once.

Start: Starts the vehicle. The engine may not start when the vehicle starts.

- Press the brake pedal, and then press the button for any length of time. An indicator light on the button illuminates when then ignition is on and when the engine starts.

STARTING A GASOLINE ENGINE

When you start the engine, the idle speed increases. This helps to warm up the engine. If the engine idle speed does not slow down automatically, have your vehicle checked by an authorized dealer.

Note: You can crank the engine for a total of 60 seconds (without the engine starting) before the starting system temporarily disables. The 60 seconds does not have to be all at once. For example, if you crank the engine three times for 20 seconds each time, without the engine starting, you reached the 60-second time limit. A message appears in the information display alerting you that you exceeded the cranking time. You cannot attempt to start the engine for at least 15 minutes. After 15 minutes, you are limited to a 15-second engine cranking time. You need to wait 60 minutes before you can crank the engine for 60 seconds again.

Before starting the engine, check the following:

- Make sure all occupants have fastened their safety belts.
- Make sure the headlamps and electrical accessories are off.
- Make sure the parking brake is on.
- Move the transmission selector lever to position **P**.
- Turn the ignition key to on. If your vehicle is equipped with a keyless ignition, see the following instructions.

Vehicles with an Ignition Key

Note: Do not touch the accelerator pedal.

1. Fully press the brake pedal. If your vehicle is equipped with a manual transmission, fully press the clutch pedal also.
2. Turn the key to start to start the engine. Release the key when the engine starts.

Note: The engine may continue cranking for up to 15 seconds or until it starts.

Note: If you cannot start the engine on the first try, wait for a short period and try again.

Starting and Stopping the Engine

Vehicles with Keyless Start

Note: Do not touch the accelerator pedal.

Note: You must have your intelligent access key in the vehicle in order to shift the transmission out of position **P**.

1. Fully press the brake pedal.
2. Press the button.

The system does not function if:

- The key frequencies are jammed.
- The key battery has no charge.

If you are unable to start the engine, locate the backup slot (A) in one of two positions:

Type One

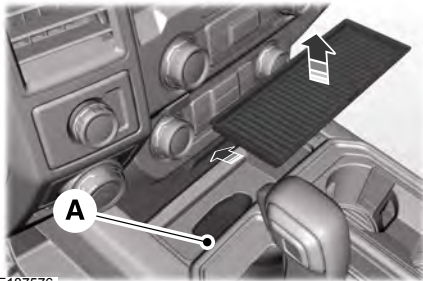

E187576

Type Two



E187577

1. If your vehicle is equipped with Type One, make sure to place the key properly into the backup slot.

2. If your vehicle is equipped with Type Two, make sure the buttons are facing the rear of the vehicle and the key ring up. Place the key into the backup slot.
3. With the key in this position, press the brake pedal, and then the button to switch on the engine.

Fast Restart

The fast restart feature allows you to restart the engine within 20 seconds of switching it off, even if a valid key is not present.

Within 20 seconds of switching the engine off, press the brake pedal and press the button. After 20 seconds have expired, you can no longer restart the engine without the key present inside your vehicle.

Once the engine has started, it remains running until you press the button, even if the system does not detect a valid key. If you open and close a door while the engine is running, the system searches for a valid key. You cannot restart the engine if the system does not detect a valid key within 20 seconds.

Failure to Start

If you cannot start the engine after three attempts, wait 10 seconds and follow this procedure:

1. Fully press the brake pedal.
2. Move the transmission selector lever to position **P**.
3. Fully press the accelerator pedal and hold it there.
4. Start the engine.

Starting and Stopping the Engine

Automatic Engine Shutdown

If your vehicle is equipped with a keyless ignition, it has a feature that automatically shuts down the engine if it has been idling for an extended period. The ignition also turns off in order to save battery power. Before the engine shuts down, a message appears in the information display showing a timer counting down from 30 seconds. If you do not intervene within 30 seconds, the engine shuts down. Another message appears in the information display to inform you that the engine has shut down in order to save fuel. Start your vehicle as you normally do.

Automatic Engine Shutdown Override

Note: You cannot permanently switch off the automatic engine shutdown feature. When you switch it off temporarily, it turns on at the next ignition cycle.

You can stop the engine shutdown, or reset the timer, at any point before the 30-second countdown has expired by doing any of the following:

- You can reset the timer by interacting with your vehicle (such as pressing the brake pedal or accelerator pedal).
- You can temporarily switch off the shutdown feature any time the ignition is on (for the current ignition cycle only). Use the information display to do so. See **Information Displays** (page 103).
- During the countdown before engine shutdown, you are prompted to press OK or RESET (depending on your type of information display) to temporarily switch the feature off (for the current ignition cycle only).

Stopping the Engine When Your Vehicle is Stationary

Vehicles with an Ignition Key

1. Move the transmission selector lever to position **P**.
2. Turn the key to off.
3. Apply the parking brake.

Vehicles with Keyless Start

1. Move the transmission selector lever to position **P**.
2. Press the button once.
3. Apply the parking brake.

Note: This switches off the ignition, all electrical circuits, warning lamps and indicators.

Note: If the engine is idling for 30 minutes, the ignition and engine automatically shut down.

Stopping the Engine When Your Vehicle is Moving

WARNING



Switching off the engine when the vehicle is still moving will result in a loss of brake and steering assistance. The steering will not lock, but higher effort will be required. When the ignition is switched off, some electrical circuits, including air bags, warning lamps and indicators may also be off. If the ignition was turned off accidentally, you can shift into neutral (N) and re-start the engine.

Vehicles with an Ignition Key

1. Move the transmission selector lever to position **N** and use the brakes to bring your vehicle to a safe stop.
2. When your vehicle has stopped, move the transmission selector lever to position **P** and turn the key to off.

Starting and Stopping the Engine

3. Apply the parking brake.

Vehicles with Keyless Start

1. Move the transmission selector lever to position **N** and use the brakes to bring your vehicle to a safe stop.
2. When your vehicle has stopped, move the transmission selector lever to position **P**.
3. Press and hold the button for one second, or press it three times within two seconds.
4. Apply the parking brake.

Guarding Against Exhaust Fumes

WARNING



If you smell exhaust fumes inside your vehicle, have your vehicle checked by your authorized dealer immediately. Do not drive your vehicle if you smell exhaust fumes. Carbon monoxide is present in exhaust fumes. Take precautions to avoid its dangerous effects.

Important Ventilating Information

If you stop your vehicle and leave the engine idling for long periods, we recommend that you do one of the following:

- Open the windows at least 1 in (2.5 cm).
- Set your climate control to outside air.

ENGINE BLOCK HEATER (if

Equipped)

WARNINGS



Failure to follow engine block heater instructions could result in property damage or serious personal injury.

WARNINGS



Do not use your heater with ungrounded electrical systems or two-pronged adapters. There is a risk of electrical shock.



Do not fully close the hood, or allow it to drop under its own weight when using the engine block heater. This could damage the power cable and may cause an electrical short resulting in fire, injury and property damage.

Note: *The heater is most effective when outdoor temperatures are below 0°F (-18°C).*

The heater acts as a starting aid by warming the engine coolant. This allows the climate control system to respond quickly. The equipment includes a heater element (installed in the engine block) and a wire harness. You can connect the system to a grounded 120-volt AC electrical source.

We recommend that you do the following for a safe and correct operation:

- Use a 16-gauge outdoor extension cord that is product certified by Underwriter's Laboratory (UL) or Canadian Standards Association (CSA). This extension cord must be suitable for use outdoors, in cold temperatures, and be clearly marked Suitable for Use with Outdoor Appliances. Do not use an indoor extension cord outdoors. This could result in an electric shock or become a fire hazard.
- Use as short an extension cord as possible.
- Do not use multiple extension cords.
- Make sure that when in operation, the extension cord plug and heater cord plug connections are free and clear of water. This could cause an electric shock or fire.

Starting and Stopping the Engine

- Make sure your vehicle is parked in a clean area, clear of combustibles.
- Make sure the heater, heater cord and extension cord are firmly connected.
- Check for heat anywhere in the electrical hookup once the system has been operating for approximately 30 minutes.
- Make sure the system is unplugged and properly stowed before starting and driving your vehicle. Make sure the protective cover seals the prongs of the block heater cord plug when not in use.
- Make sure the heater system is checked for proper operation before winter.

Using the Engine Block Heater

Make sure the receptacle terminals are clean and dry prior to use. Clean them with a dry cloth if necessary.

The heater uses 0.4 to 1.0 kilowatt-hours of energy per hour of use. The system does not have a thermostat. It achieves maximum temperature after approximately three hours of operation. Using the heater longer than three hours does not improve system performance and unnecessarily uses electricity.

Unique Driving Characteristics

AUTO-START-STOP (If Equipped)

The system helps reduce fuel consumption by automatically shutting off and restarting the engine while stopped. The engine will restart automatically when you release the brake pedal.

In some situations, your vehicle may restart automatically, for example:

- To maintain interior comfort.
- To recharge the battery.

Note: Power assist steering turns off when the engine is off.

WARNINGS



The engine may restart automatically if required by the system.



Switch the ignition off before opening the hood or performing any maintenance. Failure to do so may result in serious injuries due to automatic engine restart.



Always switch the ignition off before leaving your vehicle, as the system may have turned the engine off, but the ignition will still be on and automatic restart may occur.

The Auto StartStop system status is available at a glance within the information display. See **Information Displays** (page 103).

Enabling Auto StartStop

The system automatically enables every time you start your vehicle if:

- You do not press the Auto StartStop button (not illuminated).
- Your vehicle exceeds an initial speed of 3 mph (4 km/h) after you have initially started your vehicle.
- You have stopped your vehicle.

- Your foot is on the brake pedal.
- The transmission is in drive (D) or Sport mode.
- The driver door is closed.
- There is adequate brake vacuum.
- The interior compartment has cooled or warmed to an acceptable level.
- The front windshield defroster is off.
- You have not turned the steering wheel rapidly or you do not have it at a sharp angle.
- The vehicle is not on a steep road grade.
- The battery is within optimal operating conditions (battery state of charge and temperature in range).
- The engine coolant is at operating temperature.
- Elevation is below about 10000 feet (3048 meters).
- Ambient temperature is moderate.
- You have selected 4X2 or Auto mode.
- The trailer is not connected.
- You have not selected Tow haul.
- You have not selected Manual mode.

Note: The system allows multiple successive Auto StartStop events, but it may not operate in conditions of heavy traffic or in extended low speed operation.



The green Auto StartStop indicator light on the instrument cluster will illuminate to indicate when the automatic engine stop occurs.



If the instrument cluster is equipped with a grey Auto StartStop indicator light, it illuminates when automatic engine stop is not available due to one of the above noted conditions not being met.

Unique Driving Characteristics

Automatic Engine Restart

Any of the following conditions will result in an automatic restart of the engine:

- You have removed your foot from the brake pedal.
- You press the accelerator pedal.
- You press the accelerator and the brake pedal at the same time.
- The driver safety belt becomes unfastened or the driver door is ajar.
- You have moved the transmission from drive (D) to any gear except park (P).
- Your vehicle is moving.
- The interior compartment does not meet customer comfort when air conditioning or heat is on.
- Fogging of the windows could occur and the air conditioning is on.
- The battery is not within optimal operating conditions.
- You have exceeded the maximum engine off time.
- When you press the Auto StartStop button with the engine automatically stopped.
- The front defroster is turned to the Max setting.

Any of the following conditions may result in an automatic restart of the engine:

- You have increased the blower fan speed or changed the climate control temperature.
- You have an electrical accessory turned on or plugged in.

Note: You may notice that the climate seat fan fluctuates during an automatic restart.

Disabling Auto StartStop



E181352

Press the Auto StartStop button located on the center console to switch the system off. The button will illuminate. This will only deactivate the system for the current ignition cycle. Press the button again to restore Auto StartStop function.

Note: If the Shift to P, Restart Engine message appears and the amber Auto StartStop indicator light is flashing, automatic restart is not available. You must restart the vehicle manually. See **Information Displays** (page 103).

If your vehicle is in an engine off Auto StartStop state and you change the transmission to reverse (R) while the brake pedal is not pressed, the message Auto StartStop Press Brake to Start Engine will appear. You must press the brake pedal within 10 seconds or a shift to park (P) and a manual restart will be required.

Fuel and Refueling

SAFETY PRECAUTIONS

WARNINGS



Do not overfill the fuel tank. The pressure in an overfilled tank may cause leakage and lead to fuel spray and fire.



The fuel system may be under pressure. If you hear a hissing sound near the fuel filler door, do not refuel until the sound stops. Otherwise, fuel may spray out, which could cause serious personal injury.



Automotive fuels can cause serious injury or death if you misuse or mishandle them.



Fuel ethanol and gasoline may contain benzene, which is a cancer-causing agent.



When refueling always shut the engine off and never allow sparks or open flames near the filler neck. Never smoke or use a cell phone while refueling. Fuel vapor is extremely hazardous under certain conditions. Avoid inhaling excess fumes.



The flow of fuel through a fuel pump nozzle can produce static electricity, which can cause a fire if you pump fuel into an ungrounded fuel container.

Observe the following guidelines when handling automotive fuel:

- Extinguish all smoking materials and any open flames before refueling your vehicle.
- Automotive fuels can be harmful or fatal if swallowed. Fuel such as gasoline is highly toxic and if swallowed can cause death or permanent injury. If swallowed, call a physician immediately, even if no symptoms are immediately apparent. The toxic effects of fuel may not be visible for hours.
- Avoid inhaling fuel vapors. Inhaling too much fuel vapor of any kind can lead to eye and respiratory tract irritation. In severe cases, excessive or prolonged breathing of fuel vapor can cause serious illness and permanent injury.
- Avoid getting fuel liquid in your eyes. If you splash fuel in your eyes, remove contact lenses (if worn), flush with water for 15 minutes and seek medical attention. Failure to seek proper medical attention could lead to permanent injury.
- Fuels can also be harmful if absorbed through the skin. If you splash fuel on your skin, clothing or both, promptly remove contaminated clothing and wash your skin thoroughly with soap and water. Repeated or prolonged skin contact with fuel liquid or vapor causes skin irritation.
- Be particularly careful if you are taking “Antabuse” or other forms of disulfiram for the treatment of alcoholism. Breathing gasoline vapors, or skin contact could cause an adverse reaction. In sensitive individuals, serious personal injury or sickness may result. If you splash fuel on your skin, promptly wash your skin thoroughly with soap and water. Consult a physician immediately if you experience an adverse reaction.

Fuel and Refueling

FUEL QUALITY

Choosing the Right Fuel Without a Flex Fuel Vehicle (If Equipped)

Use only UNLEADED gasoline or UNLEADED gasoline blended with a maximum of 15% ethanol in your gasoline vehicle. If your vehicle is a Flex Fuel Vehicle (FFV), the fuel fill inlet will have a yellow housing.

Do not use:

- Fuel containing more than 15% ethanol or E-85 fuel.
- Fuel with methanol.
- Fuels containing metallic based additives, including manganese-based compounds.
- Fuels containing the octane booster additive, methylcyclopentadienyl manganese tricarbonyl (MMT)
- Leaded fuel (The use of leaded fuel is prohibited by law).

Note: *Use of any fuel other than recommended fuel can cause powertrain damage, impair the emission control system or cause loss of vehicle performance. Any damage to vehicle that is caused by use of fuel not recommended will not be covered under warranty.*

Choosing the Right Fuel With a Flex Fuel Vehicle (If Equipped)

Use only UNLEADED gasoline or UNLEADED gasoline blended with a maximum of 85% ethanol (E-85) in your Flex Fuel Vehicle (FFV). If your vehicle is a Flex Fuel Vehicle (FFV), the fuel fill inlet will have a yellow housing.

Do not use:

- Fuels containing more than 85% ethanol or E-100 fuel.
- Fuel with methanol.

- Fuels containing metallic based additives, including manganese-based compounds.
- Fuels containing the octane booster additive, methylcyclopentadienyl manganese tricarbonyl (MMT)
- Leaded fuel (The use of leaded fuel is prohibited by law).

Note: *Use of any fuel other than recommended fuel can cause powertrain damage, impair the emission control system or cause loss of vehicle performance. Any damage to vehicle that is caused by use of fuel not recommended will not be covered under warranty.*

Octane Recommendations

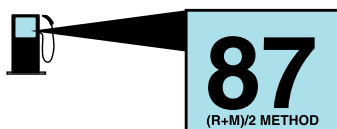

E161513

Do not be concerned if the engine sometimes knocks lightly. However, if it knocks heavily under most driving conditions while you are using fuel with the recommended octane rating, contact an authorized dealer to prevent any engine damage.

2.7L and 3.5L EcoBoost Engines

We recommend regular unleaded gasoline with a pump (R+M)/2 octane rating of 87. Some stations offer fuels posted as regular with an octane rating below 87, particularly in high altitude areas. We do not recommend fuels with an octane rating below 87.

To provide improved performance, we recommend premium fuel for severe duty usage, such as trailer tow.

Fuel and Refueling

3.5L V6 and 5.0L V8 Engines

We recommend regular unleaded gasoline with a pump (R+M)/2 octane rating of 87. Some stations offer fuels posted as regular with an octane rating below 87, particularly in high altitude areas. We do not recommend fuels with an octane rating below 87.

RUNNING OUT OF FUEL

Avoid running out of fuel. This may have an adverse effect on powertrain components.

If your vehicle runs out of fuel:

- You may need to cycle the ignition from **Off** to **On** several times after refueling to allow the fuel system to pump the fuel from the fuel tank to the engine. On restarting, cranking time will take a few seconds longer than normal.
- Normally, adding 1 gal (3.8 L) of fuel is enough to restart the engine. If the vehicle is out of fuel and on a steep grade, more than 1 gal (3.8 L) may be required.
- The service engine soon indicator may come on. For more information on the service engine soon indicator, See **Audible Warnings and Indicators** (page 102).

For information on calculating DTE (Distance to empty), See **Instrument Cluster** (page 95).

Refueling With a Portable Fuel Container

WARNINGS

 Do not insert the nozzle of a fuel container or an aftermarket funnel into the fuel filler neck. This may damage the fuel system filler neck or its seal and cause fuel to run onto the ground.

WARNINGS

 Do not try to pry open or push open the capless fuel system with foreign objects. This could damage the fuel system and its seal and cause injury to you or others.

When refueling the vehicle fuel tank from a fuel container, use the plastic funnel included with your vehicle.

- In SuperCab and SuperCrew vehicles, the funnel is located under the second row passenger side seat near the spare tire toolbox.
- On regular cab vehicles, the funnel is located behind the passenger seat.

When refueling the vehicle fuel tank from a fuel container, do the following:

1. Locate the plastic funnel.



E142668









2. Insert the plastic funnel into the fuel tank filler pipe opening.
3. Fill the vehicle with fuel from the portable fuel container.
4. Clean the plastic funnel and place it back in your vehicle or properly dispose of it.

Note: *Extra funnels can be purchased from an authorized dealer if you choose to dispose of the funnel.*

Fuel and Refueling

REFUELING

WARNINGS

-  Fuel vapor burns violently and a fuel fire can cause severe injuries.
-  Read and follow all the instructions on the pump island.
-  When refueling always shut the engine off and never allow sparks or open flames near the fuel tank filler valve. Never smoke or use a cell phone while refueling. Fuel vapor is extremely hazardous under certain conditions. Avoid inhaling excess fumes.
-  Stay outside your vehicle and do not leave the fuel pump unattended when refueling your vehicle. This is against the law in some places.
-  Keep children away from the fuel pump; never let children pump fuel.
-  Wait at least 10 seconds before removing the fuel pump nozzle to allow any residual fuel to drain into the fuel tank.
-  Stop refueling after the fuel pump nozzle automatically shuts off for the second time. Failure to follow this will fill the expansion space in the fuel tank and could lead to fuel overflowing.
-  Do not remove the fuel pump nozzle from its fully inserted position when refueling.

Use the following guidelines to avoid electrostatic charge build-up, which can produce a spark, when filling an ungrounded fuel container:

- Place approved fuel container on the ground.
- Do not fill a fuel container while it is in the vehicle (including the cargo area).

- Keep the fuel pump nozzle in contact with the fuel container while filling.
- Do not use a device that would hold the fuel pump handle in the fill position.

Easy Fuel™ Capless Fuel System

WARNING

-  The fuel system may be under pressure. If you hear a hissing sound near the fuel filler door, do not refuel until the sound stops. Otherwise, fuel may spray out, which could cause serious personal injury.

When fueling your vehicle:

1. When your vehicle has stopped, shift into park (P) and switch the ignition off.
2. Fully open the fuel tank filler door until it engages.

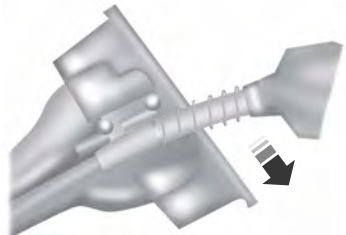

E156032

3. Insert the fuel pump nozzle up to the first notch on the nozzle. Hold handle higher during insertion for easier access. Leave the fuel pump nozzle fully inserted until you are done pumping.

Fuel and Refueling

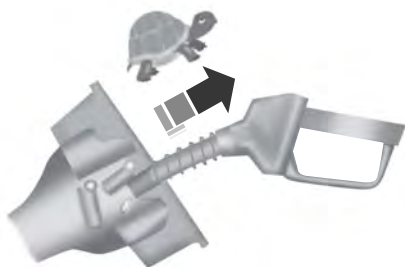

E154765

4. Remove the fuel filler nozzle and fully close the fuel tank filler door.

Note: A fuel spillage concern may occur if overfilling the fuel tank. Do not overfill the tank. The fill pipe is equipped with a drain hole. Excess fuel due to overfill may drain through the drain hole and drip onto the ground.

If the fuel fill inlet was not properly closed, a service engine warning lamp may appear on the instrument cluster.

At the next opportunity, do the following:

1. Stop your vehicle as soon as safely possible and shift the transmission into park (P).
2. Switch the ignition off.
3. Open the fuel filler door and remove any visible debris from the fuel fill opening.
4. Insert either the fuel fill nozzle or the fuel fill funnel provided with the vehicle several times to allow the inlet to close properly. This will dislodge any debris preventing the inlet from sealing.

If this action corrects the problem, the message may not reset immediately. It may take several driving cycles for the message to turn off. A driving cycle consists of an engine start-up (after 4 or more hours with the engine off) followed by city or highway driving. Continuing to drive with the message on may cause the service engine soon lamp to turn on as well.

FUEL CONSUMPTION

Empty reserve is the amount of fuel remaining in the tank after the fuel gauge indicates empty. The amount of usable fuel in the empty reserve varies and should not be relied upon to increase driving range.

- The usable capacity of the fuel tank is the amount of fuel that can be added into the tank after the gauge indicates empty
- The advertised capacity is the total fuel tank size. See **Capacities and Specifications** (page 361). It is the combined usable capacity plus the empty reserve.
- Due to the empty reserve, you may not be able to refuel the full amount of the advertised capacity of the fuel tank even when the fuel gauge reads empty.

Filling the Tank

For consistent results when refueling:

- Turn the ignition off before fueling; an inaccurate reading results if the engine is left running.
- Use the same fill rate (low-medium-high) each time the tank is filled.
- Allow no more than two automatic click-offs when filling.

Results are most accurate when the filling method is consistent.

Fuel and Refueling

Calculating Fuel Economy

Do not measure fuel economy during the first 1,000 mi (1,600 km) of driving (this is your engine's break-in period). A more accurate measurement is obtained after 2,000 mi (3,200 km) to 3,000 mi (4,800 km). Also, fuel expense, frequency of fill ups or fuel gauge readings are not accurate ways to measure fuel economy.

1. Fill the fuel tank completely and record the initial odometer reading.
2. Each time you fill the fuel tank, record the amount of fuel added.
3. After at least three fill ups, fill the fuel tank and record the current odometer reading.
4. Subtract your initial odometer reading from the current odometer reading.

To calculate L/100 km (liters per 100 kilometers) fuel consumption, multiply the liters used by 100, then divide by kilometers traveled. To calculate MPG (miles per gallon) fuel consumption, divide miles traveled by gallons used.

Keep a record for at least one month and record the type of driving (city or highway). This provides an accurate estimate of your vehicle's fuel economy under current driving conditions. Keeping records during summer and winter will show how temperature impacts fuel economy.

Conditions

- Heavily loading your vehicle reduces fuel economy.
- Carrying unnecessary weight in your vehicle may reduce fuel economy.
- Adding certain accessories to your vehicle such as bug deflectors, rollbars or light bars, running boards and ski racks may reduce fuel economy.
- Using fuel blended with alcohol may lower fuel economy.

- Fuel economy may decrease with lower temperatures.
- Fuel economy may decrease when driving short distances.
- You will get better fuel economy when driving on flat terrain than when driving on hilly terrain.

EMISSION CONTROL SYSTEM

WARNINGS



Do not park, idle, or drive your vehicle in dry grass or other dry ground cover.

The emission system heats up the engine compartment and exhaust system, which can start a fire.



Exhaust leaks may result in entry of harmful and potentially lethal fumes into the passenger compartment. If you smell exhaust fumes inside your vehicle, have your dealer inspect your vehicle immediately. Do not drive if you smell exhaust fumes.

Your vehicle is equipped with various emission control components and a catalytic converter that will enable your vehicle to comply with applicable exhaust emission standards. To make sure that the catalytic converter and other emission control components continue to work properly:

- Use only the specified fuel listed.
- Avoid running out of fuel.
- Do not turn off the ignition while your vehicle is moving, especially at high speeds.
- Have the items listed in scheduled maintenance information performed according to the specified schedule.

The scheduled maintenance items listed in scheduled maintenance information are essential to the life and performance of your vehicle and to its emissions system.

Fuel and Refueling

If you use parts other than Ford, Motorcraft or Ford-authorized parts for maintenance replacements, or for service of components affecting emission control, such non-Ford parts should be the equivalent to genuine Ford Motor Company parts in performance and durability.

Illumination of the service engine soon indicator, charging system warning light or the temperature warning light, fluid leaks, strange odors, smoke or loss of engine power could indicate that the emission control system is not working properly.

An improperly operating or damaged exhaust system may allow exhaust to enter the vehicle. Have a damaged or improperly operating exhaust system inspected and repaired immediately.

Do not make any unauthorized changes to your vehicle or engine. By law, vehicle owners and anyone who manufactures, repairs, services, sells, leases, trades vehicles, or supervises a fleet of vehicles are not permitted to intentionally remove an emission control device or prevent it from working. Information about your vehicle's emission system is on the Vehicle Emission Control Information Decal located on or near the engine. This decal also lists engine displacement

Please consult your warranty information for complete details.

On-Board Diagnostics (OBD-II)

Your vehicle has a computer known as the on-board diagnostics system (OBD-II) that monitors the engine's emission control system. The system protects the environment by making sure that your vehicle continues to meet government emission standards. The OBD-II system also assists a service technician in properly servicing your vehicle.



When the service engine soon indicator illuminates, the OBD-II system has detected a malfunction. Temporary malfunctions may cause the service engine soon indicator to illuminate.

Examples of temporary malfunctions are:

- the vehicle has run out of fuel—the engine may misfire or run poorly
- poor fuel quality or water in the fuel—the engine may misfire or run poorly
- the fuel fill inlet may not have closed properly. See **Refueling** (page 169).
- driving through deep water—the electrical system may be wet.

You can correct these temporary malfunctions by filling the fuel tank with good quality fuel, properly closing the fuel fill inlet or letting the electrical system dry out. After three driving cycles without these or any other temporary malfunctions present, the service engine soon indicator should stay off the next time you start the engine. A driving cycle consists of a cold engine startup followed by mixed city/highway driving. No additional vehicle service is required.

If the service engine soon indicator remains on, have your vehicle serviced at the first available opportunity. Although some malfunctions detected by the OBD-II may not have symptoms that are apparent, continued driving with the service engine soon indicator on can result in increased emissions, lower fuel economy, reduced engine and transmission smoothness, and lead to more costly repairs.

Fuel and Refueling

Readiness for Inspection/Maintenance (I/M) Testing

Some state/provincial and local governments may have Inspection/Maintenance (I/M) programs to inspect the emission control equipment on your vehicle. Failure to pass this inspection could prevent you from getting a vehicle registration.



If the service engine soon indicator is on or the bulb does not work, you may need to have the vehicle serviced. See On-Board Diagnostics (OBD-II).

Your vehicle may not pass the I/M test if the service engine soon indicator is on or not working properly (bulb is burned out), or if the OBD-II system has determined that some of the emission control systems have not been properly checked. In this case, your vehicle is not ready for I/M testing.

If the vehicle's engine or transmission has just been serviced, or the battery has recently run down or been replaced, the OBD-II system may indicate that the vehicle is not ready for I/M testing. To determine if the vehicle is ready for I/M testing, turn the ignition key to the on position for 15 seconds without cranking the engine. If the service engine soon indicator blinks eight times, it means that the vehicle is not ready for I/M testing; if the service engine soon indicator stays on solid, it means that the vehicle is ready for I/M testing.

The OBD-II system monitors the emission control system during normal driving. A complete check may take several days. If the vehicle is not ready for I/M testing, you may need to perform the following driving cycle consisting of mixed city and highway driving:

Drive on an expressway or highway for a steady 15 minutes, followed by 20 minutes of stop-and-go driving with at least four 30-second idle periods.

Allow the vehicle to sit for at least eight hours without starting the engine. Then, start the engine and complete the above driving cycle. The engine must warm up to its normal operating temperature. Once started, do not turn off the engine until the above driving cycle is complete. If the vehicle is still not ready for I/M testing, you will have to repeat the above driving cycle.

Transmission

AUTOMATIC TRANSMISSION

WARNINGS



Always set the parking brake fully and latch the gearshift in park (P). Turn the ignition to the off position and remove the key whenever you leave your vehicle.



Do not use the tow/haul feature when driving in icy or slippery conditions as the increased engine braking can cause the rear wheels to slide and your vehicle to swing around with the possible loss of vehicle control.

Understanding the Shift Positions of a 6-Speed Automatic Transmission (If Equipped)

Column-shift transmission:



E184457

Floor-shift transmission:

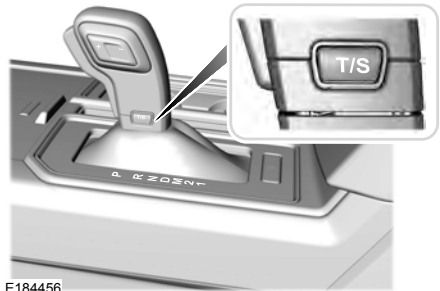

E184456

Putting your vehicle in or out of gear:

1. Fully press down the brake pedal.
2. Move the gearshift lever into the desired gear.
3. Come to a complete stop.
4. Move the gearshift lever and securely latch it in park (P).

Park (P)

This position locks the transmission and prevents the rear wheels from turning.

Reverse (R)

With the gearshift lever in reverse (R), your vehicle will move backward. Always come to a complete stop before shifting into and out of reverse (R).

Neutral (N)

With the gearshift lever in neutral (N), your vehicle can be started and is free to roll. Hold the brake pedal down while in this position.

Drive (D)

Drive (D) is the normal driving position for the best fuel economy. The overdrive function allows automatic upshifts and downshifts through gears one through six.

Transmission

Manual (M) with floor shifter

With the gearshift lever in manual (M), the driver can change gears up or down as desired. By moving the gearshift lever from drive position (D) to manual (M) you now have control of selecting the gear you desire using buttons on the shift lever. See Understanding your SelectShift Automatic™ transmission later in this section.

To return to normal drive (D) position, move the shift lever back from manual (M) to drive (D).

The transmission will operate in gears one through six.

Third (3) with column shifter

Transmission operates in third (3) gear only. Use third (3) gear for improved traction on slippery roads.

Second (2)

Transmission operates in second (2) gear only. Use second (2) gear to start-up on slippery roads.

First (1)

- Transmission operates in first (1) gear only.
- Provides maximum engine braking.
- Allows upshifts by moving gearshift lever.
- Will not downshift into first (1) gear at high speeds; allows for first (1) gear when vehicle reaches slower speeds.

Tow/Haul Mode

TOW HAUL To activate tow/haul, press the button on the gearshift lever once. The TOW HAUL indicator light will illuminate in the instrument cluster.

The tow/haul feature:

- Delays upshifts to reduce the frequency of transmission shifting.
- Provides engine braking in all forward gears, which will slow your vehicle and assist you in controlling your vehicle when descending a grade.
- Depending on driving conditions and load conditions, may downshift the transmission, slow your vehicle and control your vehicle speed when descending a hill, without pressing the accelerator pedal. The amount of downshift braking provided will vary based upon the amount the brake pedal is pressed.

The tow/haul feature improves transmission operation when towing a trailer or a heavy load. All transmission gear ranges are available when using tow/haul.

To deactivate the tow/haul feature and return to normal driving mode, press the button on the gearshift lever twice. The TOW HAUL light will deactivate. Tow/haul will also deactivate when you power down your vehicle.

WARNING



Do not use the tow/haul feature when driving in icy or slippery conditions as the increased engine braking can cause the rear wheels to slide and your vehicle to swing around with the possible loss of vehicle control.

Sport Mode



To activate Sport Mode, press the button on the gearshift lever twice. The SPORT or **S** indicator light will illuminate in the instrument display

Transmission

The sport mode feature:

- Provides additional grade (engine) braking and extends lower gear operation to enhance performance for uphill climbs, hilly terrain or mountainous areas. This will increase engine RPM during engine braking.
- Provides additional lower gear operation through the automatic transmission shift strategy.
- Selects gears more quickly and at higher engine speeds.

To deactivate the sport mode feature and return to normal driving mode, press the button on the gearshift lever once. The SPORT or **S** indicator light will deactivate. The sport mode feature will also deactivate when your vehicle is powered down.

Automatic Transmission Adaptive Learning

This feature may increase durability and provide consistent shift feel over the life of your vehicle. A new vehicle or transmission may have firm shifts, soft shifts or both. This operation is considered normal and will not affect function or durability of the transmission. Over time, the adaptive learning process will fully update transmission operation.

Forced Downshifts

- Allowed in drive (D) with the tow/haul feature on or off.
- Press the accelerator to the floor.
- Allows transmission to select an appropriate gear.

Understanding your SelectShift Automatic™ transmission (If Equipped)

Your vehicle is equipped with a SelectShift Automatic™ transmission gearshift lever. The SelectShift Automatic transmission gives you the ability to change gears up or down (without a clutch) as desired.

In order to prevent the engine from running at too low an RPM, which may cause it to stall, SelectShift will still automatically make some downshifts if it has determined that you have not downshifted in time. Although SelectShift will make some downshifts for you, it will still allow you to downshift at any time as long as the SelectShift determines that damage will not be caused to the engine from over-revving.

SelectShift will not automatically upshift, even if the engine is approaching the RPM limit. It must be shifted manually by pressing the + button.

Note: *Engine damage may occur if you maintain excessive engine revving without shifting.*

The SelectShift Automatic transmission feature has two modes: PRS and M mode.

PRS (Progressive Range Selection)

Progressive Range Selection gives you the ability to lockout gears from the automatic shifting range. This may provide you with an improved driving experience (for example, in slippery conditions or when experiencing a steep grade).

With the gearshift lever in drive (D), press the – button to active PRS. The available and selected gears are indicated on the instrument cluster.

Transmission

All available gears will display with the current gear indicated. Press the – button again to lock out gears beginning with the highest gear. Example: press the – button twice to lock out 6th and 5th gears. Only the available gears will display and the transmission will automatically shift between the available gears. Press the + button to unlock gears to allow the transmission to shift to higher gears. The transmission will shift automatically within the gear range you select.

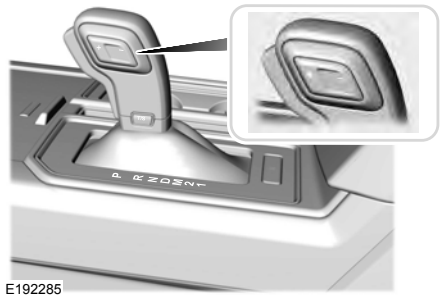

Manual (M) with floor shifter

Moving the gearshift lever to the manual (M) position will allow you to manually select the gear you desire. Only the current gear will display. Use the buttons on the gearshift lever to manually select gears. Press the + button to upshift or the – button to downshift. Return the transmission to a different gearshift position to deactivate manual control.

Upshift to the recommended shift speeds according to the following chart:

Upshifts when accelerating (recommended for best fuel economy)	
Shift from:	
1 – 2	15 mph (24 km/h)
2 – 3	25 mph (40 km/h)
3 – 4	40 mph (64 km/h)
4 – 5	45 mph (72 km/h)
5 – 6	50 mph (80 km/h)

Brake-Shift Interlock

WARNINGS



Do not drive your vehicle until you verify that the brake lamps are working.

WARNINGS



When doing this procedure, you will be taking your vehicle out of park (P) which means your vehicle can roll freely. To avoid unwanted vehicle movement, always fully set the parking brake prior to doing this procedure. Use wheel chocks if appropriate.

Transmission

WARNINGS



If you fully release the parking brake and the brake warning lamp remains illuminated, the brakes may not be working properly. See your authorized dealer.

Your vehicle is equipped with a brake-shift interlock feature that prevents moving the gearshift lever from park (P) when the ignition is in the on position and the brake pedal is not pressed.

If you cannot move the gearshift lever out of park (P) position with the ignition in the on position and the brake pedal pressed, a malfunction may have occurred. It is possible that a fuse has blown or your vehicle's brake lamps are not operating properly. See **Fuse Specification Chart** (page 289).

If the fuse is not blown and the brake lamps are working properly, the following procedure will allow you to move the gearshift lever from park (P):

Column-shifter

1. Apply the parking brake and switch off your vehicle.
2. Move the steering column to the full down and full rearward position (toward the driver's seat).
3. Remove the gearshift lever boot.
4. Place fingers into gearshift lever boot hole and pull top half of shroud up and forward to separate it from the lower half of the shroud. There is a hinge at the forward edge of the top shroud. Roll the top half of the shroud upward on the hinge point to clear the hazard flasher button, then pull straight rearward toward the driver's seat to remove.
5. Remove the top half of the shroud.

6. Remove the three fasteners under the column that secure the lower shroud half to the column.



E163185

7. Pull the lock lever into the full unlocked position and remove the lower shroud cover by pulling the lever handle through the slot in the cover.



E163186

8. Apply the brake, pull the white disk then move the shifter to neutral (N).
9. Start your vehicle.

Perform Steps 4 through 8 in reverse order, making sure to engage the hinge pivots between the upper and lower halves of the shroud. Keep slight pressure in the forward direction as the halves rotate together.

Floor-shifter

1. Apply the parking brake and switch off your vehicle.

Transmission

2. Remove the rubber mat between the shifter and cup holder. Using a screwdriver (or similar tool), carefully pry up the access panel from the attachment points and disconnect it from the console to expose the inside of the gearshift.



E182464

3. Locate the white brake shift interlock lever on the passenger side of the shifter assembly.



E183128

4. Apply the brake pedal. Using light finger pressure move the white lever forward while pulling the gearshift lever out of the park (P) position and into the neutral (N) position.
5. Install the access panel and rubber mat.

6. Apply brake pedal, start your vehicle, and release the parking brake. See your authorized dealer as soon as possible if this procedure is used.

If Your Vehicle Gets Stuck In Mud or Snow

Note: Do not rock your vehicle if the engine is not at normal operating temperature or damage to the transmission may occur.

Note: Do not rock your vehicle for more than a minute or damage to the transmission and tires may occur, or the engine may overheat.

If your vehicle gets stuck in mud or snow, you may rock it out by shifting between forward and reverse gears, stopping between shifts in a steady pattern. Press lightly on the accelerator in each gear.

Four-Wheel Drive (If Equipped)

USING FOUR-WHEEL DRIVE

WARNING



For important information regarding safe operation of this type of vehicle, see General Information in the Wheels and Tires chapter.

Note: Do not use 4H or 4L mode on dry, hard surfaced roads. Doing so can produce excessive noise, increase tire wear and may damage drive components. 4H or 4L mode is only intended for consistently slippery or loose surfaces. Use of 4L mode on these surfaces may produce some noise (such as occasional clunks), but will not damage drive components.

Note: If 4L is selected while your vehicle is moving above 3 mph (5 km/h), the 4WD system will not perform a shift. This is normal and should be no reason for concern. Refer to Shifting to or from 4L (4X4 Low) for proper operation.

4WD Indicator Lights

Note: When a 4X4 system fault is present, the system will typically remain in whichever 4X4 mode was selected prior to the fault condition occurring. It will not default to 4X2 in all circumstances. When this warning is displayed, have your vehicle serviced by an authorized dealer.

4X2



Momentarily illuminates when 2H is selected.

4X4 Auto



Continuously illuminates when 4A is selected (2-Speed Automatic 4WD vehicles only).

4X4 HIGH



Continuously illuminates when 4H is selected.

4X4 LOW



Continuously illuminates when 4L is selected.

CHECK 4X4



Displays when a 4X4 fault is present.

Using the Electronic Shift on the Fly 4WD system (If Equipped)

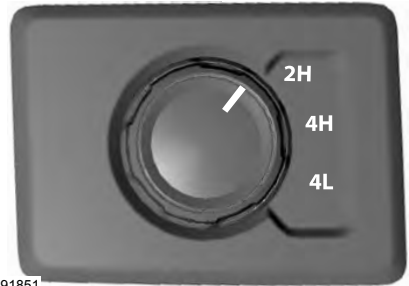

E191851

2H (4X2)

For general on-road driving. Sends power to the rear wheels only and should be used for street and highway driving. Provides optimal smoothness and fuel economy at high speeds.

4H (4X4 HIGH)

Used for extra traction such as in snow or icy roads or in off road situations. This mode is not intended for use on dry pavement.

Four-Wheel Drive (If Equipped)

4L (4X4 LOW)

Uses extra gearing to provide maximum power to all four wheels at reduced speeds. Intended only for off-road applications such as deep sand, steep grades, or pulling heavy objects. 4L (4x4 low) will not engage while your vehicle is moving above 3 mph (5 km/h); this is normal and should be no reason for concern. Refer to Shifting to or from 4L (4x4 low) for proper operation.

Shifting between system modes

Note: *Momentarily releasing the accelerator pedal while a shift in progress message displays will improve engagement/disengagement performance.*

Note: *Do not perform this operation if the rear wheels are slipping.*

Note: *You may hear some noise as the system shifts or engages; this is normal.*

You can move the control from 2H or 4H at a stop or while driving. The information display may display a message indicating a 4X4 shift is in progress. Once the shift is complete the message center will then display the system mode selected.

Shifting to or from 4L (4X4 low)

Note: *You may hear some noise as the system shifts or engages; this is normal.*

1. Bring your vehicle to a speed of 3 mph (5 km/h) or less.
2. Place the transmission in neutral (N).
3. Move the 4WD control to the desired position.

The information display will display a message indicating a 4X4 shift is in progress. The information display will then display the system mode selected. If any of the above shift conditions are not present, the shift will not occur and the information display will display information guiding the driver through the proper shifting procedures.

If **SHIFT DELAYED PULL FORWARD** displays in the information display, a transfer case gear tooth blockage is present. To alleviate this condition, place the transmission in a forward gear, move your vehicle forward approximately 5 ft (1.5 m), and shift the transmission back to neutral (N) to allow the transfer case to complete the range shift.

Using the 2-Speed Automatic 4WD System (If Equipped)

This system includes an electronically controlled transfer case with a high capacity clutch. The system is interactive with the road, continually monitoring and adjusting torque delivery to the front and rear wheels to optimize traction.

Note: *The AdvanceTrac system has the ability to take over control of the transfer case clutch and disable it during driving maneuvers when necessary.*

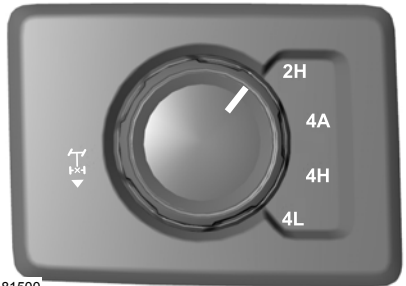

E181500

Four-Wheel Drive (If Equipped)

2H (4X2)

For general on-road driving, this mode provides optimal smoothness and fuel economy at high speeds. Sends power to the rear wheels only.

4A (4X4 AUTO)

Provides electronic control four-wheel drive with power delivered to the front and rear wheels, as required, for increased traction. This is appropriate for all on-road driving conditions, including dry road surfaces, but is especially useful on wet pavement, snow, dirt, or gravel.

4H (4X4 HIGH)

Used for extra traction such as in snow or icy roads or in off road situations. This mode is not for use on dry pavement.

4L (4X4 LOW)

Uses extra gearing to provide maximum power to all four wheels at reduced speeds. Intended only for off-road applications such as deep sand, steep grades, or pulling heavy objects. 4L (4x4 low) will not engage while your vehicle is moving above 3 mph (5 km/h); this is normal and should be no reason for concern. Refer to Shifting to or from 4L (4x4 low) for proper operation.

Shifting between system modes

Note: *Momentarily releasing the accelerator pedal while a shift in progress message displays will improve engagement/disengagement performance.*

Note: *Do not perform this operation if the rear wheels are slipping.*

Note: *You may hear some noise as the system shifts or engages; this is normal.*

You can move the control from 2H to 4A or 4H at a stop or while driving. The information display may display a message indicating a 4X4 shift is in progress. Once the shift is complete the message center will then display the system mode selected.

Shifting to or from 4L (4X4 low)

Note: *You may hear some noise as the system shifts or engages; this is normal.*

1. Bring your vehicle to a speed of 3 mph (5 km/h) or less.
2. Place the transmission in neutral (N).
3. Move the 4WD control to the desired position.

The information display will display a message indicating a 4X4 shift is in progress. The information display will then display the system mode selected. If any of the above shift conditions are not present, the shift will not occur and the information display will display information guiding the driver through the proper shifting procedures.

If **SHIFT DELAYED PULL FORWARD** displays in the information display, a transfer case gear tooth blockage is present. To alleviate this condition, place the transmission in a forward gear, move your vehicle forward approximately 5 ft (1.5 m), and shift the transmission back to neutral (N) to allow the transfer case to complete the range shift.

Four-Wheel Drive (If Equipped)

How Your Vehicle Differs From Other Vehicles

WARNING



Vehicles with a higher center of gravity such as utility and four-wheel drive vehicles handle differently than vehicles with a lower center of gravity. Utility and four-wheel drive vehicles are not designed for cornering at speeds as high as passenger cars any more than low-slung sports cars are designed to perform satisfactorily under off-road conditions. Avoid sharp turns, excessive speed and abrupt maneuvers in these vehicles. Failure to drive cautiously could result in an increased risk of loss of vehicle control, vehicle rollover, personal injury and death.

Truck and utility vehicles can differ from some other vehicles. Your vehicle may be higher to allow it to travel over rough terrain without getting hung up or damaging underbody components.

The differences that make your vehicle so versatile also make it handle differently than an ordinary passenger car.

Maintain steering wheel control at all times, especially in rough terrain. Since sudden changes in terrain can result in abrupt steering wheel motion, make sure you grip the steering wheel from the outside. Do not grip the spokes.

Drive cautiously to avoid vehicle damage from concealed objects such as rocks and stumps.

You should either know the terrain or examine maps of the area before driving. Map out your route before driving in the area. To maintain steering and braking control of your vehicle, you must have all four wheels on the ground and they must be rolling, not sliding or spinning.

Driving Off-Road With Truck and Utility Vehicles

Note: *On some models, the initial shift from two-wheel drive to four-wheel drive while your vehicle is moving can cause some momentary clunk and ratcheting sounds. This is the front drivetrain coming up to speed and the automatic locking hubs engaging and is not cause for concern.*

Note: *Your vehicle may be equipped with a front air dam that can become damaged (due to reduced ground clearance) when taking your vehicle off-road. You may remove this air dam by removing eight bolts.*

Note: *Vehicles equipped with 2.7L Ecoboost, 3.5L Ecoboost and 3.5L TiVCT engines have an underbody transmission shield and brackets that may become damaged (due to reduced ground clearance) when taking your vehicle off-road. Remove the shield by disengaging the fasteners at each corner of the shield. Then, remove the shield rear brackets by removing the bracket to frame bolts.*

Four-wheel drive vehicles are specially equipped for driving on sand, snow, mud and rough terrain and have operating characteristics that are somewhat different from conventional vehicles, both on and off the road.

The transfer case supplies power to all four wheels. On four-wheel drive vehicles, the transfer case allows you to select different 4WD modes when necessary. You can find information on transfer case operation and shifting procedures in this chapter. You can find information on transfer case maintenance in the Maintenance chapter. You should become thoroughly familiar with this information before you operate your vehicle.

Four-Wheel Drive (If Equipped)

Four-wheel drive (when you select a 4WD mode) uses all four wheels to power your vehicle. This increases traction, enabling you to drive over terrain and road conditions that a conventional two-wheel drive vehicle cannot.

Basic Operating Principles

- Drive slower in strong crosswinds which can affect the normal steering characteristics of your vehicle.
- When driving your vehicle on surfaces made slippery by loose sand, water, gravel, snow or ice proceed with care.
- Do not use four-wheel drive on dry, hard surfaced roads. Doing so will produce excessive noise, increase tire wear and may damage drive components. Four-wheel drive modes are only for consistently slippery or loose surfaces.

If Your Vehicle leaves the Road

If your vehicle leaves the road, reduce your vehicle speed and avoid severe braking. When your vehicle speed decreases, ease your vehicle back onto the road. Do not turn the steering wheel sharply while returning your vehicle to the road.

It may be safer to stay on the shoulder of the road and slow down gradually before returning to the road. You may lose control if you do not slow down or if you turn the steering wheel too sharply or abruptly.

It may be less risky to strike small objects, such as freeway reflectors, with minor damage to your vehicle rather than attempt a sudden return to the road which could cause your vehicle to slide sideways out of control or roll over. Remember, your safety and the safety of others should be your primary concern.

Emergency Maneuvers

In an unavoidable emergency situation where a sudden sharp turn must be made, remember to avoid over-driving your vehicle (i.e. turn the steering wheel only as rapidly and as far as required to avoid the emergency). Excessive steering can result in loss of vehicle control. Apply smooth pressure to the accelerator pedal or brake pedal when changes in vehicle speed are required. Avoid abrupt steering, acceleration and braking. This could result in an increased risk of vehicle roll over, loss of vehicle control and personal injury. Use all available road surface to bring your vehicle to a safe direction of travel.

In the event of an emergency stop, avoid skidding the tires and do not attempt any sharp steering wheel movements.

If your vehicle goes from one type of surface to another (i.e. from concrete to gravel) there will be a change in the way your vehicle responds to a maneuver (i.e. steering, acceleration or braking).

Sand

When driving over sand, try to keep all four wheels on the most solid area of the trail. Avoid reducing the tire pressures but shift to a lower gear and drive steadily through the terrain. Apply the accelerator slowly and avoid excessive wheel slip.

When driving at slow speeds in deep sand under high outside temperatures, use a low gear when possible. Low gear operation will maximize the engine and transmission cooling capability.

Avoid driving at excessive speeds, this causes vehicle momentum to work against you and your vehicle could become stuck to the point that assistance may be required from another vehicle. Remember, you may be able to back out the way you came if you proceed with caution.

Four-Wheel Drive (If Equipped)

Mud and Water

Mud

Be cautious of sudden changes in vehicle speed or direction when you are driving in mud. Even four-wheel drive vehicles can lose traction in slick mud. If your vehicle does slide, steer in the direction of the slide until you regain control of your vehicle.

After driving through mud, clean off residue stuck to rotating driveshafts and tires. Excess mud stuck on tires and rotating driveshafts can cause an imbalance that could damage drive components.

Water

If you must drive through high water, drive slowly. Traction or brake capability may be limited.

When driving through water, determine the depth and avoid water higher than the bottom of the hubs. If the ignition system gets wet, your vehicle may stall.

Once through water, always try the brakes. Wet brakes do not stop your vehicle as effectively as dry brakes. Drying improves by applying light pressure to the brake pedal while moving slowly.

Note: *Driving through deep water may damage the transmission. If the front or rear axle is submerged in water, the axle lubricant and power transfer unit lubricant should be checked and changed if necessary.*

Driving on Hilly or Sloping Terrain

Although natural obstacles may make it necessary to travel diagonally up or down a hill or steep incline, you should always try to drive straight up or straight down.

Note: *Avoid turning on steep slopes or hills. A danger lies in losing traction, slipping sideways and possible vehicle roll over. Whenever driving on a hill, determine beforehand the route you will use. Do not drive over the crest of a hill without seeing what conditions are on the other side. Do not drive in reverse over a hill without the aid of an observer.*

When climbing a steep slope or hill, start in a lower gear rather than downshifting to a lower gear from a higher gear once the ascent has started. This reduces strain on the engine and the possibility of stalling.

If your vehicle stalls, do not try to turn around because this could cause vehicle roll over. It is better to reverse back to a safe location.

Apply just enough power to the wheels to climb the hill. Too much power will cause the tires to slip, spin or lose traction, resulting in loss of vehicle control.



E143949

Descend a hill in the same gear you would use to climb up the hill to avoid excessive brake application and brake overheating. Do not descend in neutral. Disengage overdrive or move the transmission selector lever to a lower gear. When descending a steep hill, avoid sudden hard braking as you could lose control. The front wheels have to be turning in order to steer your vehicle.

Four-Wheel Drive (If Equipped)

If your vehicle has anti-lock brakes, apply the brakes steadily. Do not pump the brakes.

Driving on Snow and Ice

WARNING



If you are driving in slippery conditions that require tire chains or cables, then it is critical that you drive cautiously. Keep speeds down, allow for longer stopping distances and avoid aggressive steering to reduce the chances of a loss of vehicle control which can lead to serious injury or death. If the rear end of your vehicle slides while cornering, steer in the direction of the slide until you regain control of your vehicle.

Note: *Excessive tire slippage can cause transmission damage.*

Four-wheel drive vehicles have advantages over two-wheel drive vehicles in snow and ice but can skid like any other vehicle. Should you start to slide while driving on snowy or icy roads, turn the steering wheel in the direction of the slide until you regain control.

Avoid sudden applications of power and quick changes of direction on snow and ice. Apply the accelerator slowly and steadily when starting from a full stop.

Avoid sudden braking. Although a four-wheel drive vehicle may accelerate better than a two-wheel drive vehicle in snow and ice, it will not stop any faster as braking occurs at all four wheels. Do not become overconfident as to road conditions.

Make sure you allow sufficient distance between you and other vehicles for stopping. Drive slower than usual and consider using one of the lower gears. In emergency stopping situations, apply the brake steadily. Do not pump the brake pedal. See **Hints on Driving With Anti-Lock Brakes** (page 190).

If Your Vehicle Gets Stuck In Mud or Snow

WARNING



Do not spin the wheels at over 35 mph (56 km/h). The tires may fail and injure a passenger or bystander.

If your vehicle gets stuck in mud or snow, you may rock it out by shifting between forward and reverse gears, stopping between shifts in a steady pattern. Press lightly on the accelerator in each gear.

Note: *Do not rock your vehicle if the engine is not at normal operating temperature, damage to the transmission may occur.*

Note: *Do not rock your vehicle for more than a minute, damage to the transmission and tires may occur or the engine may overheat.*

Parking

WARNINGS



If the parking brake is fully released, but the brake warning lamp remains illuminated, the brakes may not be working properly. See your authorized dealer.



Always set the parking brake fully and make sure the gearshift is latched in park (P). Turn the ignition to the off position and remove the key whenever you leave your vehicle.

Four-Wheel Drive (If Equipped)

On some four-wheel drive vehicles, when the transfer case is in the neutral (N) position, the engine and transmission disconnect from the rest of the driveline. Therefore, your vehicle is free to roll even if the automatic transmission is in park (P) or the manual transmission is in gear. Do not leave your vehicle unattended with the transfer case in the neutral (N) position. Always set the parking brake fully and turn off the ignition when leaving your vehicle.

Maintenance and Modifications

The suspension and steering systems on your vehicle have been designed and tested to provide predictable performance whether loaded or empty. For this reason, we strongly recommend that you do not make modifications such as adding or removing parts (for example, lift kits or stabilizer bars) or by using replacement parts not equivalent to the original factory equipment.

We recommend that you use caution when your vehicle has either a high load or device (such as ladders or luggage racks). Any modifications to your vehicle that raise the center of gravity may cause your vehicle to roll over when there is a loss of vehicle control.

Failure to maintain your vehicle correctly may void the warranty, increase your repair cost, reduce vehicle performance and operational capabilities and adversely affect you and your passenger's safety. We recommend you frequently inspect your vehicle's chassis components when your vehicle is subject to off road usage.

Rear Axle

ELECTRONIC LOCKING DIFFERENTIAL (If Equipped)

Note: The electronic locking differential is for off-road use only and is not for use on dry pavement. Using the electronic locking differential on dry pavement will result in increased tire wear, noise and vibration.

The electronic locking differential is a device housed in the rear axle that allows both rear wheels to turn at the same speed. The electronic locking differential can provide additional traction should your vehicle become stuck. You can activate the differential electronically and shift it on the fly within the differential operating speed range. The differential is for use in mud, rocks, sand, or any off-road condition where you need maximum traction. It is not for use on dry pavement.

The following conditions will affect the electronic locking differential:

- The electronic locking differential will not engage if your vehicle speed is above 20 mph (32 km/h) in 4x2, 4x4 Auto, or 4x4 High modes.
- The electronic locking differential will not engage if your vehicle speed is above or 56 mph (90 km/h) in 4X4 Low.
- The electronic locking differential may not engage if you press your accelerator pedal during an engagement attempt. A message may display in the instrument display guiding you to release the accelerator pedal.
- In 4x2, 4x4 Auto, and 4x4 High modes, the electronic locking differential will automatically disengage at speeds above 25 mph (41 km/h) and will automatically reengage at speeds below 20 mph (32 km/h).

- In 4L (4X4 low), the electronic locking differential will automatically disengage at speeds above 62 mph (100 km/h) and will automatically reengage at speeds below 56 mph (90 km/h).
- The AdvanceTrac system has the ability to take over control of the electronic locking differential and disable it during driving maneuvers when necessary.

When you switch the system on, if you do not meet the required conditions for electronic locking differential activation, the instrument cluster will display the appropriate information guiding you through the proper activation process.

Activating the Electronic Locking Differential

Note: Do not use electronic locking differential on dry, hard surfaced roads. Doing so will produce excessive noise, vibration and increase tire wear.

Note: If the electronic locking differential has difficulty disengaging, release the accelerator pedal and turn the steering wheel in the opposite direction while rolling.

For 4WD vehicles

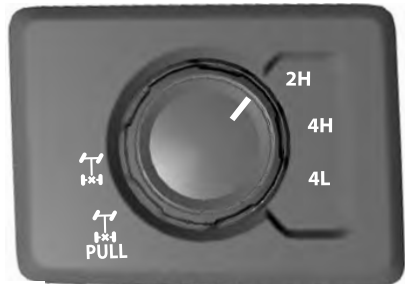

E191852

Pull the 4WD control knob toward you.

Rear Axle

For 2WD vehicles

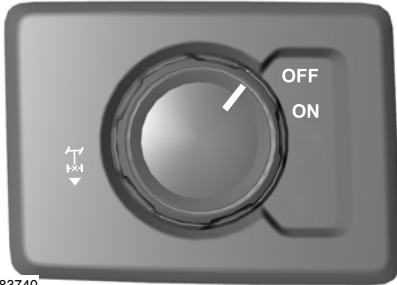

E183740

Turn the control to ON.



Once the indicator light illuminates in the information display, both rear wheel axle shafts will be locked together providing added traction.

If the indicator does not come on, or the indicator turns off while driving, one of the following has occurred:

- The vehicle speed is too high.
- The left and right rear wheel speed difference is too high during an engagement attempt.
- The system has malfunctioned and is accompanied by CHECK LOCKING DIFFERENTIAL in the information display. See your authorized Ford dealer for assistance.

Brakes

GENERAL INFORMATION

Note: Occasional brake noise is normal. If a metal-to-metal, continuous grinding or continuous squeal sound is present, the brake linings may be worn-out. Have the system checked by an authorized dealer. If your vehicle has continuous vibration or shudder in the steering wheel while braking, have it checked by an authorized dealer.

Note: Brake dust may accumulate on the wheels, even under normal driving conditions. Some dust is inevitable as the brakes wear and does not contribute to brake noise. See **Cleaning the Alloy Wheels** (page 326).



See **Warning Lamps and Indicators** (page 98).

Wet brakes result in reduced braking efficiency. Gently press the brake pedal a few times when driving from a car wash or standing water to dry the brakes.

Brake Over Accelerator

In the event the accelerator pedal becomes stuck or entrapped, apply steady and firm pressure to the brake pedal to slow the vehicle and reduce engine power. If you experience this condition, apply the brakes and bring your vehicle to a safe stop. Move the transmission to park (P), switch the engine off and apply the parking brake. Inspect the accelerator pedal for any interference. If none are found and the condition persists, have your vehicle towed to the nearest authorized dealer.

Brake Assist

Brake assist detects when you brake rapidly by measuring the rate at which you press the brake pedal. It provides maximum braking efficiency as long as you press the pedal, and can reduce stopping distances in critical situations.

Anti-lock Brake System

This system helps you maintain steering control during emergency stops by keeping the brakes from locking.



This lamp momentarily illuminates when you turn the ignition on. If the light does not illuminate during start up, remains on or flashes, the system may be disabled. Have the system checked by an authorized dealer. If the anti-lock brake system is disabled, normal braking is still effective.



If the brake warning lamp illuminates when you release the parking brake, have the system checked by an authorized dealer.

HINTS ON DRIVING WITH ANTI-LOCK BRAKES

Note: When the system is operating, the brake pedal may pulse and may travel further. Maintain pressure on the brake pedal. You may also hear a noise from the system. This is normal.

The anti-lock braking system will not eliminate the risks when:

- You drive too closely to the vehicle in front of you.
- Your vehicle is hydroplaning.
- You take corners too fast.
- The road surface is poor.

PARKING BRAKE

WARNING



Always set the parking brake fully and make sure the transmission is locked in park (P). Failure to set the parking brake and engage park could result in vehicle roll-away, property damage or bodily injury.

Brakes

To set the parking brake, press the parking brake pedal down to its fullest extent. The brake warning lamp in the instrument cluster will illuminate and remains illuminated until the parking brake is released.

To release the parking brake, press the parking brake pedal down again.

If you are parking your vehicle on a grade or with a trailer, press and hold the brake pedal down, then set the parking brake. There may be a little vehicle movement as the parking brake sets to hold the vehicle's weight. This is normal and should be no reason for concern. If needed, press and hold the service brake pedal down, then try reapplying the parking brake. Chock the wheels if required. If the parking brake cannot hold the weight of the vehicle, the parking brake may need to be serviced or the vehicle may be overloaded.

ELECTRIC PARKING BRAKE (if Equipped)

The electric parking brake replaces the conventional foot brake. The operating switch is located on the instrument panel left of the steering wheel.

WARNING



Always set the parking brake fully and make sure the transmission is locked in park (P). Failure to set the parking brake and engage park could result in vehicle roll-away, property damage or bodily injury.

Note: When you apply the electric parking brake in certain conditions, for example, on a steep hill, the electric parking brake may reapply the brakes within ten minutes.

Note: You may notice various noises when you apply and release the electric parking brake. This is normal and no cause for concern.

Applying the Electric Parking Brake

WARNING



The brake system warning lamp will flash during an electric parking brake apply. If the brake system warning lamp continues to flash there could be a problem with your electric parking brake. Have the system checked by an authorized dealer as soon as possible.

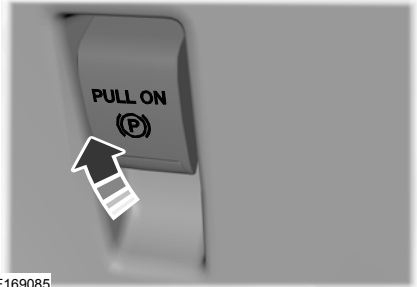

E169085

Pull the switch up to apply the electric parking brake.

The brake system warning lamp will flash for approximately two seconds and then illuminate to confirm that the electric parking brake has been applied. See **Information Displays** (page 103).

Note: The brake system warning lamp will remain illuminated for about ten seconds if you switch the ignition off with the parking brake applied, or apply the parking brake while the ignition is off.

Note: The electric parking brake will not automatically apply. You must apply the electric parking brake using the electric parking brake switch.

Brakes

Applying the Electric Parking Brake When the Vehicle is Moving

WARNINGS

 Applying the electric parking brake while moving will result in use of the anti-lock braking system. Do not use the electric parking brake system when the vehicle is moving unless the normal brake system is unable to stop the vehicle.

 With the exception of emergency conditions (for example, the brake pedal does not work or is blocked), do not apply the electric parking brake while the vehicle is moving. On bends, or poor road surfaces or weather conditions, emergency braking can cause the vehicle to skid out of control or off the road.

If you apply the electric parking brake when your vehicle is moving, the brake system warning lamp will illuminate and a warning tone will sound. See **Information Displays** (page 103).

If your vehicle speed is above 4 mph (6 km/h), the braking force is applied as long as the switch is pulled. Release or press the switch or press the accelerator pedal to stop the braking force.

Releasing the Electric Parking Brake

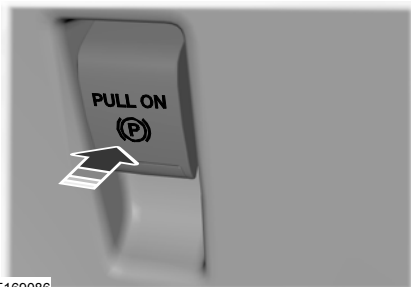

E169086

You can release the electric parking brake either manually by pressing the switch or automatically.

Manual Release

WARNING

 If the brake system warning light remains illuminated or flashes after you have released the parking brake, there could be a problem with your braking system. Have the system checked by an authorized dealer as soon as possible.

You can manually release the electric parking brake by:

- Switching the ignition on.
- Pressing the brake pedal.
- Pressing the electric parking brake switch.

When the electric parking brake is released, the brake system warning lamp will turn off.

Driving With a Trailer

Depending on the grade and the weight of the trailer, your vehicle and trailer may roll backwards slightly when you start on a slope.

To prevent this from happening, do the following:

1. Pull the switch up and hold it in this position.
2. Drive your vehicle, then release the switch when you notice that the engine has developed sufficient driving force.

Brakes

Automatic Release - Drive Away Release

Your vehicle will automatically release the parking brake if:

- The driver door is closed.
- The transmission is in a forward or reverse gear.
- The vehicle is accelerated.
- There are no faults detected in the parking brake system.

The brake system warning lamp will go off to confirm that you have released the electric parking brake.

Note: *If the electric parking brake warning lamp stays illuminated, the electric parking brake will not automatically release. You must release the electric parking brake using the electric parking brake switch.*

Note: *The electric parking brake drive away release makes starting on a hill easier. This feature will release the parking brake automatically when the vehicle has sufficient drive force to move up the hill.*

Battery With No Charge

WARNING



You will not be able to apply or release the electric parking brake if the battery is low or has no charge.

If the battery is low or has no charge, use jumper cables and a booster battery.

HILL START ASSIST

WARNINGS



The system does not replace the parking brake. When you leave your vehicle, always apply the parking brake. Failure to leave your vehicle securely parked may lead to a crash or injury. See **Parking Brake** (page 190).

WARNINGS



You must remain in your vehicle when the system turns on. At all times, you are responsible for controlling your vehicle, supervising the system and intervening, if required. Failure to take care may result in the loss of control of your vehicle, serious personal injury or death.



The system will turn off if a malfunction is apparent or if you rev the engine excessively. Failure to take care may result in the loss of control of your vehicle, serious personal injury or death.

The system makes it easier to pull away when your vehicle is on a slope without the need to use the parking brake.

When the system is active, your vehicle remains stationary on the slope for two to three seconds after you release the brake pedal. This allows time to move your foot from the brake to the accelerator pedal. The system releases the brakes automatically once the engine has developed sufficient torque to prevent your vehicle from rolling down the slope. This is an advantage when pulling away on a slope, for example from a car park ramp, traffic lights or when reversing uphill into a parking space.

Note: *The system only functions when you bring your vehicle to a complete standstill in an uphill gear (for example, drive (D) when facing uphill or reverse (R) when facing downhill).*

Note: *There is no warning light to indicate the system is either on or off.*

Using Hill Start Assist

1. Press the brake pedal to bring your vehicle to a complete standstill. Keep the brake pedal pressed.

Brakes

2. If the sensors detect that your vehicle is on a slope, the system activates automatically.
3. When you remove your foot from the brake pedal, your vehicle remains on the slope without rolling away for about two to three seconds. This hold time automatically extends if you are in the process of driving off.
4. Drive off in the normal manner. The system releases the brakes automatically.

Note: *When you remove your foot from the brake pedal and press the pedal again when the system is active, you will experience significantly reduced brake pedal travel. This is normal.*

Switching the System On and Off

Vehicles with Manual Transmission

You can switch this feature on or off in the information display. The system remembers the last setting when you start your vehicle.

Vehicles with Automatic Transmission

You cannot turn the system on or off. When you switch the ignition on, the system automatically turns on.

Traction Control

PRINCIPLE OF OPERATION

The traction control system helps avoid drive wheel spin and loss of traction.

If your vehicle begins to slide, the system applies the brakes to individual wheels and, when needed, reduces engine power at the same time. If the wheels spin when accelerating on slippery or loose surfaces, the system reduces engine power in order to increase traction.

USING TRACTION CONTROL

In certain situations (for example, stuck in snow or mud), you can turn the traction control off. This may be beneficial as this allows the wheels to spin with full engine power.

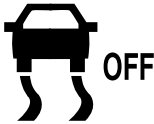

E166706

Turn the traction control system off by pressing the stability control button located on the center of the instrument panel.

System Indicator Lights and Messages

WARNING



If a failure has been detected within the traction control system, the stability control light will illuminate steadily. Verify that the traction control system was not manually disabled using the stability control button. If the stability control light still illuminates steadily, have the system serviced by an authorized dealer immediately. Operating your vehicle with traction control disabled could lead to an increased risk of loss of vehicle control, vehicle rollover, personal injury and death.



The stability control light temporarily illuminates on engine start-up or if a problem occurs in the stability system, and flashes when a driving condition activates the stability system.



The stability control off light temporarily illuminates on engine start-up and stays on when you turn the traction control system off.

Stability Control

PRINCIPLE OF OPERATION

WARNINGS



Vehicle modifications involving braking system, aftermarket roof racks, suspension, steering system, tire construction and wheel and tire size may change the handling characteristics of your vehicle and may adversely affect the performance of the electronic stability control system. In addition, installing any stereo loudspeakers may interfere with and adversely affect the electronic stability control system. Install any aftermarket stereo loudspeaker as far as possible from the front center console, the tunnel, and the front seats in order to minimize the risk of interfering with the electronic stability control sensors. Reducing the effectiveness of the electronic stability control system could lead to an increased risk of loss of vehicle control, vehicle rollover, personal injury and death.



Remember that even advanced technology cannot defy the laws of physics. It's always possible to lose control of a vehicle due to inappropriate driver input for the conditions. Aggressive driving on any road condition can cause you to lose control of your vehicle increasing the risk of personal injury or property damage. Activation of the electronic stability control system is an indication that at least some of the tires have exceeded their ability to grip the road; this could reduce the operator's ability to control the vehicle potentially resulting in a loss of vehicle control, vehicle rollover, personal injury and death. If your electronic stability control system activates, SLOW DOWN.

The system automatically turns on each time you switch the ignition on.

If a driving condition activates either the stability control or the traction control system you may experience the following conditions:

- The stability and traction control light flashes.
- Your vehicle slows down.
- Reduced engine power.
- A vibration in the brake pedal.
- The brake pedal is stiffer than usual.
- If the driving condition is severe and your foot is not on the brake, the brake pedal may move as the systems applies higher brake forces.

The stability control system has several features built into it to help you maintain control of your vehicle:

Electronic Stability Control

The system enhances your vehicle's ability to prevent skids or lateral slides by applying brakes to one or more of the wheels individually and, if necessary, reducing engine power.

Roll Stability Control

The system enhances your vehicle's ability to prevent rollovers by detecting your vehicle's roll motion and the rate at which it changes by applying the brakes to one or more wheels individually.

Traction Control

The system enhances your vehicle's ability to maintain traction of the wheels by detecting and controlling wheel spin. See **Using Traction Control** (page 195).

Stability Control

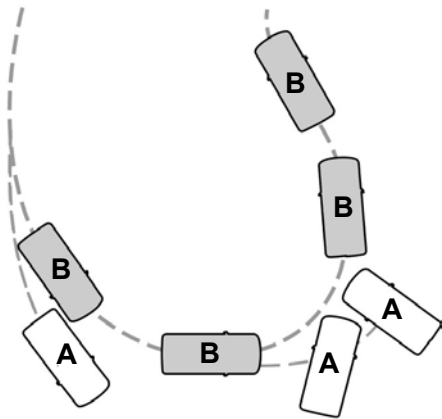

E72903

A Vehicle without stability control

skidding off its intended route.

B Vehicle with stability control maintaining control on a slippery surface.

USING STABILITY CONTROL

AdvanceTrac™ with Roll Stability Control™ (RSC™)

The system automatically turns on each time you switch the ignition on.

You can switch the electronic stability control systems off.

When you shift the transmission into reverse (R), the systems are disabled.

You can switch the traction control system off or on independently. See **Using Traction Control** (page 195).

AdvanceTrac with RSC Features

Button functions	Stability control OFF light	Roll stability control	Electronic stability control	Traction control system
Default at start-up	Illuminated during bulb check	Enabled	Enabled	Enabled
Button pressed momentarily	Illuminated	Enabled	Enabled	Disabled
Button pressed and held for more than 5 seconds	Illuminated	Enabled	Disabled	Disabled

Stability Control

AdvanceTrac with RSC Features				
Double press	Illuminated	Enabled	Enabled with higher threshold target	Enabled with higher threshold target
Button pressed again after deactivation	Not illuminated	Enabled	Enabled	Enabled
Transfer case switched to 4WD Low	Illuminated	Disabled	Disabled	Disabled

Terrain Response (If Equipped)

PRINCIPLE OF OPERATION

WARNINGS



Hill descent control cannot control descent in all surface conditions and circumstances, such as ice or extremely steep grades. Hill descent control is a driver assist system and cannot substitute for good judgment by the driver. Failure to do so may result in loss of vehicle control, crash or serious injury.



Hill descent control does not provide hill hold at zero miles per hour (0 kilometers per hour). When stopped, the parking brake must be applied or the vehicle must be placed in **P** (Park) or it may roll away.

Hill descent control allows the driver to set and maintain vehicle speed while descending steep grades in various surface conditions.

Hill descent control can maintain vehicle speeds on downhill grades between 2 mph (3 km/h) and 12 mph (20 km/h). Above 20 mph (32 km/h), the system remains armed, but descent speed cannot be set or maintained.

Hill descent control requires a cooling down interval after a period of sustained use. The amount of time that the feature can remain active before cooling varies with conditions. The system will provide a warning in the message center and a chime will sound when the system is about to disengage for cooling. At this time, manually apply the brakes as needed to maintain descent speed.

USING HILL DESCENT CONTROL



Press and release the hill descent button located on the instrument panel. A light in the cluster will illuminate and a chime will sound when this feature is activated.

To increase descent speed, press the accelerator pedal until you reach the desired speed. To decrease descent speed, press the brake pedal until you reach the desired speed.

When accelerating or decelerating, once you reach the desired descent speed, remove your feet from the pedals and hill descent control maintains the chosen vehicle speed.

Note: *Noise from the ABS pump motor may be observed during hill descent control operation. This is a normal characteristic of the ABS and should be no reason for concern.*

Hill descent modes

- At speeds between 2 mph (3 km/h) and 20 mph (32 km/h): When the Hill Descent Control switch is pressed and Hill Descent Control is active, the Hill Descent Control indicator light flashes. Your vehicle maintains your desired speed.
- At speeds between 20 mph (32 km/h) and 40 mph (64 km/h): When the Hill Descent Control switch is pressed, the Hill Descent Control system is enabled, the Hill Descent Control indicator light is solid and a message displays in the information display. Your vehicle does not maintain your desired speed and you cannot set your descent speed.

Terrain Response (If Equipped)

- At speeds above 40 mph (64 km/h):
When the Hill Descent Control switch is pressed, the Hill Descent Control system is disabled, the indicator light in the cluster does not illuminate and a message does not display in the information display. The system is turned off and you need to switch the system back on to use.

Refer to the Information Displays for additional Hill Descent Control messages. See **Information Messages** (page 118).

Parking Aids

PARKING AID (If Equipped)

WARNINGS



To help avoid personal injury, please read and understand the limitations of the system as contained in this section. Sensing is only an aid for some (generally large and fixed) objects when moving in reverse on a flat surface at parking speeds. Certain objects with surfaces that absorb ultrasonic waves, traffic control systems, fluorescent lamps, inclement weather, air brakes, and external motors and fans may also affect the function of the sensing system; this may include reduced performance or a false activation.



To help avoid personal injury, always use caution when in reverse (R) and when using the sensing system.



This system is not designed to prevent contact with small or moving objects. The system is designed to provide a warning to assist the driver in detecting large stationary objects to avoid damaging your vehicle. The system may not detect smaller objects, particularly those close to the ground.



Certain add-on devices such as large trailer hitches, bike or surfboard racks and any device that may block the normal detection zone of the system, may create false beeps.

Note: *Keep the sensors, located on the bumper or fascia, free from snow, ice and large accumulations of dirt. If the sensors are covered, the system's accuracy can be affected. Do not clean the sensors with sharp objects.*

Note: *If your vehicle sustains damage to the bumper or fascia, leaving it misaligned or bent, the sensing zone may be altered causing inaccurate measurement of obstacles or false alarms.*

Note: *If your vehicle is equipped with MyKey™, it is possible to prevent turning the sensing system off. See MyKey™ (page 57).*

Note: *If your vehicle is equipped with a trailer tow package and a trailer is connected to your vehicle, the rear sensing system will be disabled and will not allow you to switch the system on through the information display. When you shift your vehicle into reverse (R), a message appears in the information display stating that a trailer is connected and the rear sensing system is disabled. If equipped, the center stack rear sensing system display will not be present.*

The sensing system warns the driver of obstacles within a certain range of the bumper area. The system turns on automatically when you switch on the ignition.

When receiving a detection warning, the radio volume reduces to a predetermined level. After the warning goes away, the radio volume returns to the previous level.

You can switch the system off through the information display menu or from the pop-up message that appears once the transmission is shifted into reverse (R).

If a fault is present in the system, a warning message appears in the information display and will not allow you to switch the faulted system on.

Rear Sensing System

The rear sensors are only active when the transmission is in reverse (R). As your vehicle moves closer to the obstacle, the rate of the audible warning increases. When the obstacle is less than 12 in (30 cm) away, the warning sounds

Parking Aids

continuously. If a stationary or receding object is detected farther than 12 in (30 cm) from the side your vehicle, the tone sounds for only three seconds. Once the system detects an object approaching, the warning sounds again.



E130178

- A The coverage area is up to 6 feet (1.8 meters) from the rear bumper. There is decreased coverage area at the outer corners of the bumper.

The system detects certain objects while the transmission is in reverse (R):

- and moving toward a stationary object at a speed of 3 mph (5 km/h) or less.
- but not moving, and a moving object is approaching the rear of your vehicle at a speed of 3 mph (5 km/h) or less.
- and moving at a speed of less than 3 mph (5 km/h) and a moving object is approaching the rear of your vehicle at a speed of less than 3 mph (5 km/h).

The system provides audio warnings only when your vehicle is moving or when your vehicle is stationary and the detected obstacle is fewer than 12 in (30 cm) away from the bumper.

The system provides obstacle distance indication through the center stack display (if equipped). The distance indication will be present when the transmission is in reverse (R).

- As the distance to the obstacle decreases (obstacle becomes closer), the indicator blocks will illuminate and move towards the vehicle icon.
- If there is no obstacle detected, the distance indicator blocks will be grayed out.

ACTIVE PARK ASSIST (If Equipped)

WARNINGS



Designed to be a supplementary park aid, this system may not work in all conditions. This system cannot replace the driver's attention and judgment. The driver is responsible for avoiding hazards and maintaining a safe distance and speed, even when the system is in use.



Active Park Assist does not apply the brakes under any circumstances.

Note: *The driver is always responsible for controlling the vehicle, supervising the system and intervening if required.*

Active Park Assist is an electronic parking aid that uses ultrasonic sensors. The system detects an available parallel parking space and automatically steers your vehicle into the space (hands-free) while you control the accelerator, gearshift and brakes. The system visually and audibly instructs you to park your vehicle.

Parking Aids

The system may not function correctly if something passes between the front bumper and the parking space (a pedestrian or cyclist) or if the edge of the neighboring parked vehicle is high off the ground (for example, a bus, tow truck or flatbed truck).

Note: *The sensors may not detect objects in heavy rain, snow or other conditions that cause disruptive reflections.*

Note: *Keep the sensors, located on the bumper or fascia, free from snow, ice and large accumulations of dirt. Covered sensors can affect the system's accuracy. Do not clean the sensors with sharp objects.*

Note: *The sensors may not detect objects with surfaces that absorb ultrasonic waves.*

Do not use the system if:

- You have attached a foreign object (bike rack or trailer) to the front or rear of your vehicle or close to the sensors.
- You have attached an overhanging object (surfboard) to the roof.

- A foreign object damages or obstructs the sensors.
- The correct tire size is not in use on your vehicle (for example, a mini-spare tire).

Using Active Park Assist



Press the button located on the center console near the gearshift lever.

The touchscreen displays a message and a corresponding graphic to indicate it is searching for a parking space. Use the direction indicator to indicate which side of your vehicle you want the system to search.

Note: *The system automatically searches on the passenger side. You can use the direction indicator to toggle between the driver and passenger side.*

Note: *You can also activate the Active Park Assist system after you have already driven partially or completely past a parking space. To do so, press the Active Park button and the system will inform you if you have recently passed a suitable parking space.*

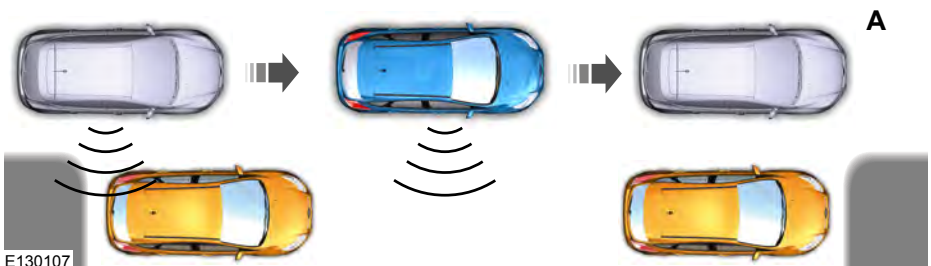

When the system finds a suitable space, the touchscreen displays a message and a tone sounds. Stop your vehicle and follow the instructions on the touchscreen. If your vehicle is moving very slowly, you may need to pull forward a short distance before the system is ready to park.

Note: *You must observe that the selected space remains clear of obstructions at all times in the maneuver.*

Parking Aids

Note: Active park assist may not detect vehicles with overhanging loads (a bus or a truck), street furniture such as benches and fire hydrants and other items. You must make sure the selected space is suitable for parking.

Note: You should drive your vehicle within 5 ft (1.5 m) and as parallel to the other vehicles as possible while passing a parking space.

Note: The system always offers the last detected parking space (for example, if the vehicle detects multiple spaces while you are driving, it offers the last one).



When you think your vehicle is properly parked, or you hear a solid tone from the parking aid (accompanied by a touchscreen display message and a chime), bring your vehicle to a complete stop.

When automatic steering is finished, the touch screen displays a message and a tone sounds, indicating that the active park assist process is done. The driver is responsible for checking the parking job and making any necessary corrections before putting the transmission in park (P).

Note: If driven above approximately 22 mph (35 km/h), the touchscreen shows a message to alert you to reduce your vehicle speed.

Automatic Steering into Parking Space

Note: If your vehicle speed exceeds 6 mph (9 km/h), the system turns off and you need to take full control of your vehicle.

When you shift the transmission into reverse (R), with your hands off the wheel (and nothing obstructing its movement), your vehicle steers itself into the space. Indicated by tones, instructions to move your vehicle back and forth in the space appear on the display screen.

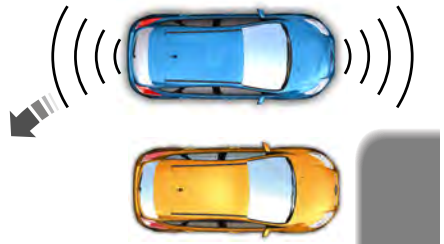

Deactivating the Park Assist Feature

Manually deactivate the system by:

- Pressing the active park assist button.
- Grabbing the steering wheel during automatic steering.
- Driving above approximately 22 mph (35 km/h) for 30 seconds during an active park search.
- Driving above 6 mph (9 km/h) during automatic steering.
- Turning off the traction control system.

Parking Aids

Certain vehicle conditions can also deactivate the system, such as:

- Traction control has activated on a slippery or loose surface.
- There is an anti-lock brake system activation or failure.

If a problem occurs with the system, a warning message displays, followed by a tone. Occasional system messages may occur in normal operation. For recurring or frequent system faults, contact an authorized dealer to have your vehicle serviced.

Troubleshooting the System

The system does not look for a space

The traction control system may be off.

The transmission is in reverse (R); your vehicle must be moving forward to detect a parking space.

You recently disconnected or replaced the battery. After a battery disconnect, you must drive your vehicle for a short period of time before Active Park Assist becomes functional.

The system does not offer a particular space

Something may be contacting the sensors.

There is not enough room in the parking space for the vehicle to safely park.

There is not enough space for the parking maneuver on the opposite side of the parking space.

Your vehicle is farther than 4.9 ft (1.5 m) from the parking space.

Your vehicle is closer than 16 in (40 cm) from neighboring parked vehicles.

The transmission is in reverse (R); your vehicle must be moving forward to detect a parking space.

Your vehicle is going faster than 22 mph (35 km/h).

The system does not position the vehicle where I want in the space

Your vehicle is rolling in the opposite direction of the transmission (rolling forward with reverse (R) selected).

An irregular curb along the parking space prevents the system from aligning your vehicle properly.

Vehicles or objects bordering the space may not be positioned correctly.

Parking Aids

The system does not position the vehicle where I want in the space

You pulled your vehicle too far past the parking space. The system performs best when you drive the same distance past the parking space.

The tires may not be installed or maintained correctly (not inflated correctly, improper size, or of different sizes).

A repair or alteration has changed detection capabilities.

A parked vehicle has a high attachment (salt sprayer, snowplow or moving truck bed).

The parking space length or position of parked objects changed after your vehicle passed.

The temperature around your vehicle changes quickly (driving from a heated garage into the cold, or after leaving a car wash).

You didn't wait for the steering wheel to complete its rotation after a gear change. The system performs best when the steering wheel is allowed to finish rotating before accelerating.

REAR VIEW CAMERA (If Equipped)

WARNINGS



The rear view camera system is a reverse aid supplement device that still requires the driver to use it in conjunction with the interior and exterior mirrors for maximum coverage.



Objects that are close to either corner of the bumper or under the bumper, might not be seen on the screen due to the limited coverage of the camera system.



Back up as slow as possible since higher speeds might limit your reaction time to stop your vehicle.



Use caution when using the rear video camera when the tailgate is ajar. If the tailgate is ajar, the camera will be out of position and the video image may be incorrect. All guidelines have been removed when the tailgate is ajar.

WARNINGS



Use caution when turning camera features on or off while in reverse (R). Make sure your vehicle is not moving.

The rear view camera system provides a video image of the area behind your vehicle.

During operation, lines appear in the display which represent your vehicle's path and proximity to objects behind your vehicle.



E184050

Parking Aids

The camera is located on the tailgate handle.

Using the Rear View Camera System

The rear view camera system displays what is behind your vehicle when you place the transmission in reverse (R).

Note: *The reverse sensing system is not effective at speeds above 3 mph (5 km/h) and may not detect certain angular or moving objects.*

The system uses three types of guides to help you see what is behind your vehicle:

- Active guidelines: Show the intended path of your vehicle while reversing.
- Fixed guidelines: Show the actual path your vehicle is moving in while reversing in a straight line. This can be helpful when backing into a parking space or aligning your vehicle with another object behind you.
- Centerline: Helps align the center of your vehicle with an object (for example, a trailer).

Note: *If the image comes on while the transmission is not in reverse (R), have the system inspected by your authorized dealer.*

Note: *When towing, the camera only sees what you are towing behind your vehicle. This might not provide adequate coverage as it usually provides in normal operation and you might not see some objects. In some vehicles, the guidelines may disappear once you engage the trailer tow connector.*

Note: *If your vehicle is equipped with Pro Trailer Backup Assist you can set-up the trailer to work with the Rear View Camera system.*

The camera may not operate correctly under the following conditions:

- Nighttime or dark areas if the reverse lamps are not operating.
- Mud, water or debris obstructs the camera's view. Clean the lens with a soft, lint-free cloth and non-abrasive cleaner.
- The rear of your vehicle is hit or damaged, causing the camera to become misaligned.

Guidelines and the Centerline

Note: *Active guidelines and fixed guidelines are only available when the transmission is in reverse (R).*

Note: *The centerline is only available if active or fixed guidelines are on.*

Parking Aids

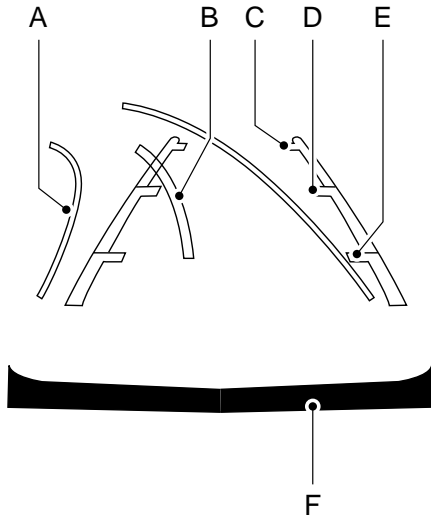

E142436

- A Active guidelines
- B Centerline
- C Fixed guideline: Green zone
- D Fixed guideline: Yellow zone
- E Fixed guideline: Red zone
- F Rear bumper

Active guidelines only show with fixed guidelines. To use active guidelines, turn the steering wheel to point the guidelines toward an intended path. If the steering wheel position changes while reversing, your vehicle might deviate from the original intended path.

The fixed and active guidelines fade in and out depending on the steering wheel position. The active guidelines do not show when the steering wheel position is straight.

Always use caution while reversing. Objects in the red zone are closest to your vehicle and objects in the green zone are farther away. Objects are getting closer to your vehicle as they move from the green zone to the yellow or red zones. Use the side view mirrors and rear view mirror to get better coverage on both sides and rear of your vehicle.

Manual Zoom

WARNING



When manual zoom is on, the full area behind your vehicle is not shown. Be aware of your surroundings when using the manual zoom feature.

Note: Manual zoom is only available when the transmission is in reverse (R).

Note: Only the centerline shows when you enable manual zoom.

Selectable settings for this feature are Zoom in (+) and Zoom out (-). Press the symbol on the camera screen to change the view. The default setting is Zoom OFF.

This allows you to get a closer view of an object behind your vehicle. The zoomed image keeps the bumper in the image to provide a reference. The zoom is only active while the transmission is in reverse (R).

Camera System Settings

To access any of the rear view camera system settings, make the following selections in the multifunctional display when the transmission is not in reverse (R):

- Menu > Vehicle > Camera Settings

Parking Aids

Enhanced Park Aids

Selectable settings for this feature are ON and OFF.

The system uses red, yellow and green highlights that appear on top of the video image when any of the sensing systems detect an object.

Vehicles equipped with MyFord Touch™

The system will provide an image of your vehicle and the sensor zones. The zones will highlight green, yellow and red when the parking aid sensors detect an object in the coverage area.



E190459

For additional information of the zone coverage and the rear sensing system. See **Parking Aid** (page 201).

Rear Camera Delay

Selectable settings for this feature are ON and OFF.

The default setting for the rear camera delay is OFF.

When shifting the transmission out of reverse (R) and into any gear other than park (P), the camera image remains in the display until your vehicle speed reaches 6 mph (10 km/h). This occurs when the rear camera delay feature is on, or until a radio button is pressed.

360 DEGREE CAMERA (If Equipped)

WARNINGS



The 360 degree camera system is a supplement system that still requires the driver to use it in conjunction with looking out the windows, and checking the interior and exterior mirrors for maximum coverage.



You may not see objects that are close to either corner of the bumper or under the bumper due to the limited coverage of the camera system.



Use caution when turning camera features ON or OFF while out of park (P). Make sure your vehicle is not moving.

The 360 degree camera system consists of front, side and rear cameras. The system:

- Allows you to see what is directly in front or behind your vehicle.
- Provides cross traffic view in front and behind your vehicle.
- Allows you to see a top-down view of the area outside your vehicle, including the blind spots.
- Provides visibility around your vehicle to you in parking maneuvers such as:
 - Centering in a parking space.
 - Obstacles near vehicle.
 - Parallel parking.

Parking Aids



The 360 degree camera system button is located on the instrument panel and allows you to toggle through different camera views. The front and rear cameras have multiple screens which consist of: Normal view with 360, Normal view, and split view. When in park (P), neutral (N) or drive (D), only the front images will be displayed when the button is pressed. When in reverse (R), only the rear images will be displayed when the button is pressed.

Note: *The 360 degree camera system will turn OFF when your vehicle is in motion at low speed, except when in reverse (R).*

Camera Views

The small vehicle icon displayed on the top left corner of the image illustrates the camera view being displayed. Camera views are laid out in the order the screens will appear once the button is pressed.

Note: *The front video image will be disabled when your vehicle is in motion at low speed, except when in reverse (R).*

- **Front 360 + Normal:** Contains the normal front camera view next to a 360 degree camera view. This view will appear on the screen when the button is pressed in any gear other than reverse (R).
- **Front Normal View:** Provides an image of what is directly in front of your vehicle. Access this view by pressing the camera button from the Front 360 + Normal View screen.
- **Front Split View:** Provides an extended view of what is in front of your vehicle. Access this view by pressing the camera button from the Front Normal View screen.

- **Rear 360 + Normal:** Contains the normal rear camera view next to a 360 degree camera view. This view can be accessed by putting your vehicle in reverse (R), or by pressing the camera button from the Rear Split View screen.
- **Rear Normal View:** Provides an image of what is directly behind your vehicle. Access this view by pressing the camera button from the Rear 360 + Normal screen.
- **Rear Split View:** Provides an extended view of what is behind your vehicle. Access this view by pressing the camera button from the Rear Normal View screen.

Keep Out Zone

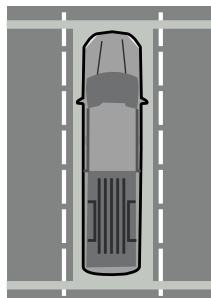

E184448

The Keep Out Zone is represented by the yellow dotted lines running parallel to your vehicle. It is designed to give you the indication on the ground of the fully extended outside mirror position.

Front Camera

WARNING



The front camera system is an aid supplement device that still requires the driver to use it in conjunction with looking out your vehicle.

Parking Aids



E184044

The front video camera, located in the grille, provides a video image of the area in front of your vehicle. It adds assistance to the driver while driving forward at low speeds. To use the front video camera system, place the transmission in any gear except reverse (R). An image will display once the camera enable button is pressed. The area displayed on the screen may vary according to your vehicle's orientation and/or road condition.

Side Camera

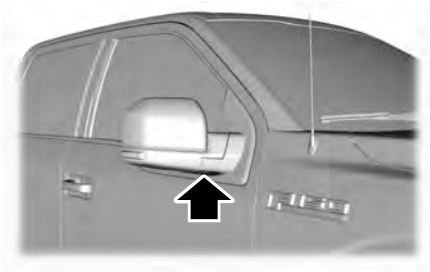

E206263

The side view camera, located in the outside mirror, provides a video image of the area on the sides of your vehicle as part of the front 360 + normal view and rear 360 + normal view. It aids you while parking your vehicle either forward or backwards.

Cruise Control (If Equipped)

PRINCIPLE OF OPERATION

Cruise control lets you maintain a set speed without keeping your foot on the accelerator pedal. You can use cruise control when your vehicle speed is greater than 20 mph (30 km/h).

USING CRUISE CONTROL

WARNINGS



Do not use cruise control on winding roads, in heavy traffic or, when the road surface is slippery. This could result in loss of vehicle control, serious injury or death.



When you are going downhill, your vehicle speed may increase above the set speed. The system will not apply the brakes. Change down a gear to assist the system in maintaining the set speed. Failure to do so could result in loss of vehicle control, serious injury or death.

Note: Cruise control will disengage if the vehicle speed decreases more than 10 mph (16 km/h) below the set speed while driving uphill.

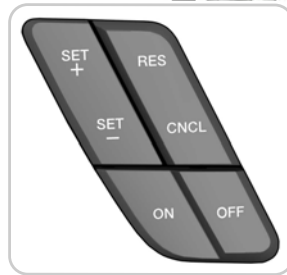

E191819

The cruise controls are on the steering wheel.

Switching Cruise Control On and Off

Switching Cruise Control On

Press and release **ON**.



The indicator appears in the instrument cluster.

Setting the Cruise Speed

1. Drive to desired speed.
2. Press and release **SET+**.
3. Take your foot off the accelerator pedal.

The indicator color changes.

Cruise Control (If Equipped)

Changing the Set Speed

Note: If you accelerate by pressing the accelerator pedal, the set speed will not change. When you release the accelerator pedal, your vehicle returns to the speed that you previously set.

- Press the accelerator or brake pedal until you reach the desired speed. Press and release **SET+**.
- Press and hold **SET+** or **SET-**. Release the control when you reach the desired speed.
- Press and release **SET+** or **SET-**. The set speed will change in approximately 1 mph (2 km/h) increments.

Canceling the Set Speed

Press **CNCL** or tap the brake pedal, this action does not erase the set speed.

Resuming the Set Speed

Press and release **RES**.

Switching Cruise Control Off

Press and release **OFF** or switch the ignition off.







Note: You will erase the set speed if you switch the system off.

USING ADAPTIVE CRUISE CONTROL (If Equipped)

WARNINGS

 Always pay close attention to changing road conditions, especially when using adaptive cruise control. Adaptive cruise control cannot replace attentive driving. Failing to follow any of the warnings below or failing to pay attention to the road may result in a crash, serious injury or death.

WARNINGS

-  Adaptive cruise control is not a crash warning or avoidance system.
-  Adaptive cruise control does not detect stationary or slow moving vehicles below 6 mph (10 km/h).
-  Adaptive cruise control does not detect pedestrians or objects in the roadway.
-  Adaptive cruise control does not detect oncoming vehicles in the same lane.
-  Do not use the adaptive cruise control when entering or leaving a highway, in heavy traffic or on roads that are winding, slippery or unpaved.
-  Do not use in poor visibility, specifically fog, rain, spray or snow.

Note: It is your responsibility to stay alert, drive safely and control the vehicle at all times.

The system adjusts your speed to maintain a proper distance between you and the vehicle in front of you in the same lane. You can select from one of four gap settings.



E183737

The controls for using your cruise control are located on the steering wheel.

Cruise Control (If Equipped)

Switching the System On

Press and release **ON**.



The information display shows the grey indicator light.



E183738

The current gap setting and **SET** also shows.

Setting a Speed

1. Accelerate to the desired speed.
2. Press and release **SET+**. The memory stores the vehicle speed.
3. The information display shows a green indicator light, current gap setting and the desired set speed.
4. Take your foot off the accelerator pedal.



E183738

5. A lead vehicle graphic illuminates if the system detects a vehicle in front of you.

Note: *When adaptive cruise control is active, the speedometer may vary slightly from the set speed displayed in the information display.*

Following a Vehicle

WARNINGS



When following a vehicle in front of you, your vehicle does not decelerate automatically to a stop, nor does your vehicle always decelerate quickly enough to avoid a crash without driver intervention. Always apply the brakes when necessary. Failing to do so may result in a crash, serious injury or death.



Adaptive cruise control only warns of vehicles detected by the radar sensor. In some cases there may be no warning or a delayed warning. You should always apply the brakes when necessary. Failing to do so may result in a crash, serious injury or death.

Note: *The brakes may emit a sound when the adaptive cruise control system is active.*

When a vehicle ahead of you enters the same lane or a slower vehicle is ahead in the same lane, the vehicle speed adjusts to maintain a preset gap distance. The distance setting is adjustable.

The lead vehicle graphic illuminates.

The vehicle maintains a constant distance from the vehicle ahead until:

- The vehicle in front of you accelerates to a speed above the set speed.
- The vehicle in front of you moves out of your lane or out of view.
- The vehicle speed falls below 12.4 mph (20 km/h).
- You set a new gap distance.

Cruise Control (If Equipped)

The system applies the brakes to slow the vehicle to maintain a safe distance from the vehicle in front. The system applies only limited maximum braking. Press the brake pedal to override the system.

If the system predicts that its maximum braking level is insufficient, an audible warning sounds while the system continues to brake. A red warning bar appears on the windshield heads-up display. Take immediate action to slow or stop the vehicle.

The system may provide slight temporary acceleration when you use your driver side directional indicator while following a lead vehicle, to aid in passing the vehicle.

Setting the Gap Distance

Note: *It is your responsibility to select a gap appropriate to the driving conditions.*

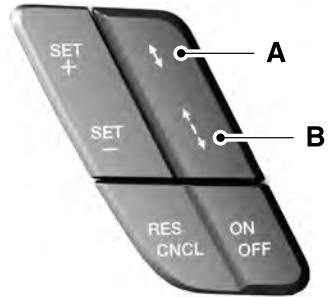

E183739

A Gap decrease.

B Gap increase.

Press the gap control to decrease or increase the distance between your vehicle and the vehicle in front of you.



E183738

Bars in the graphic show the selected gap distance. You can select between four gap settings.

Cruise Control (If Equipped)

Adaptive cruise control distance-between-vehicle settings

Set speed mph (km/h)	Graphic display, bars indicated between vehicles	Time gap, seconds	Distance gap yd (m)	Dynamic beha- vior
62 (100)	1	1	31 (28)	Sport.
62 (100)	2	1.4	43 (39)	Normal.
62 (100)	3	1.8	55 (50)	Normal.
62 (100)	4	2.2	67 (61)	Comfort.

Each time you start the vehicle, the system selects the last chosen gap for the current driver.

Disengaging the System

Press the brake pedal or press **CNCL**. The last set speed displays in grey but does not erase.

Overriding the System

WARNING



Whenever you press the accelerator pedal and override the system, the system no longer automatically applies the brakes to maintain separation from any vehicle ahead.

While you press the accelerator pedal, you override the set speed and gap distance.



When you override the system, the green indicator light illuminates and the lead vehicle graphic does not show in the information display.

The system resumes operation when you release the accelerator pedal. The vehicle speed decreases to the set speed, or to a lower speed if following a slower vehicle.

Changing the Set Speed

- Accelerate or brake to the desired speed, then press and release **SET+**.
- Press and hold **SET+** or **SET-** until the desired set speed shows on the information display. The vehicle speed gradually changes to the selected speed.
- Press and release **SET+** or **SET-**. The set speed changes in approximately 1.2 mph (2 km/h).

The system may apply the brakes to slow the vehicle to the new set speed. The set speed displays continuously in the information display while the system is active.

Resuming the Set Speed

Note: Only use resume if you are aware of the set speed and intend to return to it.

Press and release **RES**. The vehicle returns to the previously set speed. The set speed shows continuously in the information display while the system is active.

Cruise Control (If Equipped)

Low Speed Automatic Cancellation

The system does not function at vehicle speeds below 12.4 mph (20 km/h). An audible alarm sounds and the automatic braking releases if the vehicle drops below this speed.

Hilly Condition Usage

Note: An audible alarm sounds and the system shuts down if it applies brakes for an extended period of time. This allows the brakes to cool. The system functions normally again when the brakes have cooled.

Select a lower gear when the system is active in situations such as prolonged downhill driving on steep grades, for example in mountainous areas. The system needs additional engine braking in these situations to reduce the load on the vehicle's regular brake system to prevent it from overheating.

Switching the System Off

Note: The set speed memory erases when you switch off the system.

Press and release **OFF** or switch off the ignition.

Detection Issues

WARNING



On rare occasions, detection issues can occur due to the road infrastructures, for example bridges, tunnels and safety barriers. In these cases, the system may brake late or unexpectedly. At all times, you are responsible for controlling your vehicle, supervising the system and intervening, if required.

The radar sensor has a limited field of vision. It may not detect vehicles at all or detect a vehicle later than expected in some situations. The lead vehicle graphic does not illuminate if the system does not detect a vehicle in front of you.

A

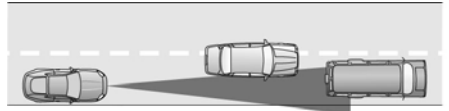

B

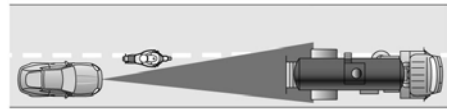

C

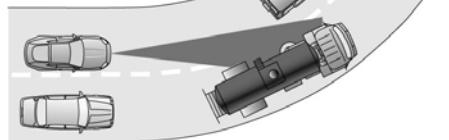

E71621

Detection issues can occur:

- A When driving on a different line than the vehicle in front.
- B With vehicles that edge into your lane. The system can only detect these vehicles once they move fully into your lane.
- C There may be issues with the detection of vehicles in front when driving into and coming out of a bend or curve in the road.

Cruise Control (If Equipped)

In these cases the system may brake late or unexpectedly. Stay alert and take action when necessary.

If something hits the front end of your vehicle or damage occurs, the radar-sensing zone may change. This could cause missed or false vehicle detections. Contact an authorized dealer to have them check for proper coverage and operation.

System Not Available

Conditions that can cause the system to deactivate or prevent the system from activating when requested include:

- A blocked sensor.
- High brake temperature.
- A failure in the system or a related system.

Note: *If you disable electronic stability control, adaptive cruise control is not available. See **Using Stability Control** (page 197).*

Blocked Sensor

WARNINGS

 Do not use the system when towing a trailer with aftermarket trailer brake controls. Aftermarket trailer brakes will not function properly when you switch the system on because the brakes are electronically controlled. Failing to do so may result in loss of vehicle control, which could result in serious injury.

WARNINGS



Do not use adaptive cruise control while you have a snow plow blade installed.



Do not use tire sizes other than those recommended because this can affect the normal operation of the system. Failing to do so may result in a loss of vehicle control, which could result in serious injury.

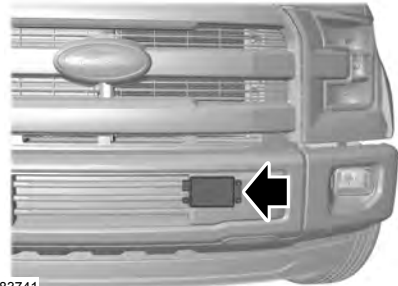

E183741

A message displays if something obstructs the radar signals from the sensor. The sensor is behind a cover near the driver side of the lower grille. The system cannot detect a vehicle ahead and does not function when something obstructs the radar signals. The following table lists possible causes and actions for this message displaying.

Cruise Control (If Equipped)

Cause	Action
The surface of the radar in the grille is dirty or obstructed in some way.	Clean the grille surface in front of the radar or remove the object causing the obstruction.
The surface of the radar in the grille is clean but the message remains in the display.	Wait a short time. It may take several minutes for the radar to detect that it is free from obstruction.
Heavy rain or snow is interfering with the radar signals.	Do not use the system in these conditions because it may not detect any vehicles ahead.
Swirling water, or snow or ice on the surface of the road may interfere with the radar signals.	Do not use the system in these conditions because it may not detect any vehicles ahead.
You are in a desert or remote area with no other vehicles and no roadside objects.	Wait a short time or switch to normal cruise control.

Due to the nature of radar technology, it is possible to get a blockage warning and not have a blockage. This can happen, for example, when driving in sparse rural or desert environments. A false blocked condition either self clears or clears after a key cycle.

Switching to Normal Cruise Control

WARNING



Normal cruise control does not brake due to slower vehicles. Always be aware of which mode you have selected and apply the brakes when necessary.



The cruise control indicator light replaces the adaptive cruise control indicator light if you select normal cruise control. The gap setting does not display, the system does not automatically respond to lead vehicles and automatic braking is not active. The system recalls its last setting when you start your vehicle.

You can manually change from adaptive cruise control to normal cruise control through the information display. See **Information Messages** (page 118).

Driving Aids

DRIVER ALERT (If Equipped)

WARNING



The driver alert system is designed to aid you. It is not intended to replace your attention and judgment. You are still responsible to drive with due care and attention.

Note: *The system will store the on or off setting in the information display menu through ignition cycles.*

Note: *If enabled in the menu, the system will be active at speeds above 40 mph (64 km/h).*

Note: *The system works as long as one lane marking can be detected by the camera.*

Note: *If the camera is blocked or if the windshield is damaged, the system may not function.*

Note: *The system may not be available in poor weather or other low visibility conditions.*

The system automatically monitors your driving behavior using various inputs including the front camera sensor.

If the system detects that your driving alertness is reduced below a certain threshold, the system will alert you using a chime and a message in the information display.

Using Driver Alert

Switching the system on and off

You may switch the system on or off through the information display by selecting Settings then Driver Assist then Driver Alert in the menu. When activated, the system will monitor your alertness level based upon your driving behavior in relation to the lane markings, and other factors.

System Warnings

Note: *Note: The system will not issue warnings below approximately 40 mph (64 km/h).*

The warning system is in two stages. At first the system issues a temporary warning that you need to take a rest. This message will only appear for a short time. If the system detects further reduction in driving alertness, another warning may be issued which will remain in the information display for a longer time. Press OK on the steering wheel control to clear the warning. When active the system will run automatically in the background and only issue a warning if required.

Resetting the System

You can reset the system by either:

- Switching the ignition off and on.
- Stopping the vehicle and then opening and closing the driver's door.

LANE KEEPING SYSTEM (If

Equipped)

WARNING



The system is designed to aid the driver. It is not intended to replace your attention and judgment. You are still responsible to drive with due care and attention.

Note: *The system works above 40 mph (64 km/h).*

Note: *The system works as long as the camera can detect one lane marking.*

Note: *The system may not function if the camera is blocked or there is damage to the windshield.*

Driving Aids

Note: When Aid mode is on and the system detects no steering activity for a short period, the system will alert you to put your hands on the steering wheel. The system may detect a light grip or touch on the steering wheel as hands off driving.

The system notifies you to stay in your lane through the steering system and the instrument cluster display when the front camera detects an unintentional drift out of your lane is likely to occur. The system automatically detects and tracks the road lane markings using a camera mounted behind the interior rear view mirror.

Switching the System On and Off

Note: The system on or off setting is stored until it is manually changed, unless a MyKey® is detected. If the system detects a MyKey®, it defaults to on and the mode is set to alert.

Note: If a MyKey® is detected, pressing the button will not affect the on or off status of the system. You can only change the mode and intensity settings.



Press the button located on the center console to switch the system on or off.

System Settings

The system has one standard feature setting and one optional setting menu available. To view or adjust the settings, See **General Information** (page 103). The system stores the last known selection for each of these settings. You do not need to readjust your settings each time you turn on the system.

Mode: This setting allows you to select which of the system features you can enable.

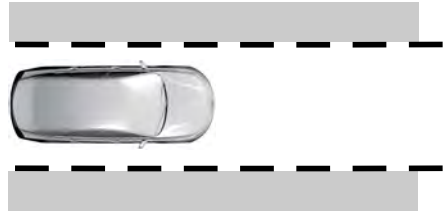

E165515

Alert only – Provides a steering wheel vibration when an unintended lane departure is detected.

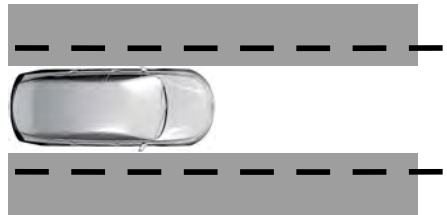

E165516

Aid only – Provides a steering wheel vibration when the system detects an unintended lane departure.

Driving Aids

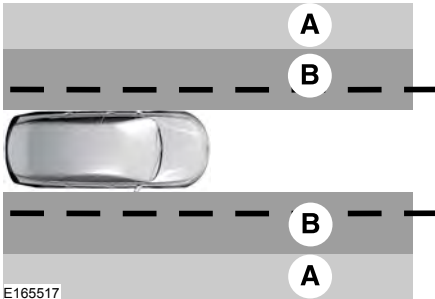

A Alert

B Aid

Alert + Aid – Provides an assistance steering torque input toward the lane center. If your vehicle continues drifting out of the lane, the system provides a steering wheel vibration.

Note: The alert and aid diagrams illustrate general zone coverage. They do not provide exact zone parameters.

Intensity: This setting affects the intensity of the steering wheel vibration used for the alert and alert + aid modes. This setting does not affect the aid mode.

- Low
- Medium
- High

System Display



When you switch on the system, an overhead graphic of a vehicle with lane markings will display in the information display.



If you select aid mode when you switch on the system, arrows will be displayed with lane markings.

When you switch off the system, the lane marking graphics will not display.

Note: The overhead vehicle graphic may still be displayed if adaptive cruise control is enabled.

While the system is on, the color of the lane markings will change to indicate the system status.

Gray: Indicates that the system is temporarily unable to provide a warning or intervention on the indicated side(s). This may be because:

- Your vehicle is under the activation speed.
- Your turn indicator is active.
- Your vehicle is in a dynamic maneuver.
- The road has no or poor lane markings in the camera field-of-view.
- The camera is obscured or unable to detect the lane markings due to environmental conditions (significant sun angles, shadows, snow, heavy rain, fog), traffic conditions (following a large vehicle that is blocking or shadowing the lane), or vehicle conditions (poor headlamp illumination).

See **Troubleshooting** for additional information.

Green: Indicates that the system is available or ready to provide a warning or intervention, on the indicated side(s).

Yellow: Indicates that the system is providing or has just provided a lane keeping aid intervention.

Red: Indicates that the system is providing or has just provided a lane keeping alert warning.

You can temporarily disable the system at any time by doing the following

- Quick braking.
- Fast acceleration.
- Using your direction indicator.
- Evasive steering maneuver.

Driving Aids

Troubleshooting

Why is the feature not available (line markings are gray) when I can see the lane markings on the road?
Vehicle speed is outside the operational range of the feature
Sun is shining directly into the camera lens
Quick intentional lane change
Staying too close to the lane marking
Driving at high speeds in curves
Previous feature activation happened within the last one second
Ambiguous lane markings (mainly in construction zones)
Rapid transition from light to dark or vice versa
Sudden offset in lane markings
ABS or AdvanceTrac activation
Camera blockage due to dirt, grime, fog, frost or water on the windshield
Driving too close to the vehicle in front of you
Transitioning between no lane markings to lane markings or vice versa
Standing water on the road
Faint lane markings (partial yellow lane markings on concrete roads)
Lane width too narrow or too wide
Camera not calibrated after a windshield replacement
Driving on tight roads or on uneven roads
Vehicle accessories such as snow plows

Why does the vehicle not come back into the middle of the lane always, as expected, in the Aid or Aid + Alert mode?
High cross winds
Large road crown
Rough roads, grooves, shoulder drop-offs

Driving Aids

Why does the vehicle not come back into the middle of the lane always, as expected, in the Aid or Aid + Alert mode?

Heavy uneven loading of the vehicle or improper tire inflation pressure

If the tires have been exchanged (including snow tires), or the suspension has been modified

Vehicle accessories such as snow plows or trailers

BLIND SPOT INFORMATION SYSTEM

WARNING



To help avoid injuries, NEVER use the Blind Spot Information System as a replacement for using the interior and exterior mirrors or looking over your shoulder before changing lanes. The Blind Spot Information System is not a replacement for careful driving.

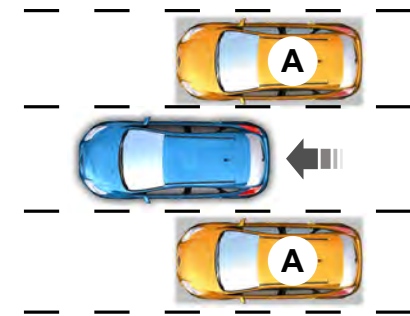

E124788

The Blind Spot Information System is designed to aid you in detecting vehicles that may have entered the blind spot zone (A). The detection area is on both sides of your vehicle, extending rearward from the exterior mirrors to approximately 13 ft (4 m) beyond the bumper. The system is designed to alert you if certain vehicles enter the blind spot zone while driving.

Note: *The Blind Spot Information System does not prevent contact with other vehicles or objects; nor detect parked vehicles, people, animals or infrastructure (fences, guardrails, trees). It's only designed to alert you to vehicles in the blind spot zones.*

Note: *When a vehicle passes quickly through the blind spot zone, typically fewer than two seconds, the system does not trigger.*

Using the System

The Blind Spot Information System turns on when you start the engine and you drive your vehicle forward above 5 mph (8 km/h).

For automatic transmissions, the Blind Spot Information System remains on while the transmission is in drive (D). If shifted into reverse (R) or park (P) the Blind Spot Information System turns off. Once shifted back into drive (D), the Blind Spot Information System turns back on when you drive your vehicle above 5 mph (8 km/h).

Driving Aids

For manual transmissions, the Blind Spot Information System is on for all gears except the reverse (R).

Note: *The Blind Spot Information System does not function in reverse (R) or park (P).*

System Lights and Messages



E142442

The Blind Spot Information System illuminates an amber alert indicator in the outside mirror on the side of your vehicle the approaching vehicle is coming from. When the Blind Spot Information System is alerting on a vehicle and the corresponding turn signal is ON, the Blind Spot Information System alert indicator flashes as an increased warning level.

The alert indicator dims when the system detects nighttime darkness.

Note: *The alert indicator flashes in case of an alert and the turn signal is set to that side at the same time.*

System Sensor Blockage

WARNING



To help avoid injuries, NEVER use the Blind Spot Information System as a replacement for using the interior and exterior mirrors or looking over your shoulder before changing lanes. The Blind Spot Information System is not a replacement for careful driving.

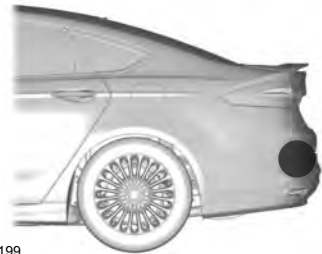

E205199

The system uses radar sensors that are located behind the bumper fascia on each side of your vehicle. Any dirt, mud and snow in front of the sensors and/or driving in heavy rain can cause system degradation. Also, other types of obstructions in front of the sensor can cause system degradation. This is referred to as a 'blocked' condition.

Note: *Do not apply bumper stickers and/or repair compound to these areas, this can cause degraded system performance.*

Driving Aids

If the system detects a degraded performance condition, a message warning of a blocked sensor will appear in the information display. Also the BLIS alert indicators will remain ON and BLIS will no longer provide any vehicle warnings. You can clear the information display warning but the alert indicators will remain illuminated.

A "blocked" condition can be cleared in two ways:

- After the blockage in front of the sensors is removed or the rainfall/snowfall rate decreases or stops, drive for a few minutes in traffic to allow the sensors to detect passing vehicles.
- By cycling the ignition from ON to OFF and then back ON.

Note: *If your vehicle has a tow bar with a factory equipped trailer tow module and it is towing a trailer, the sensors will automatically turn the Blind Spot Information System off. If your vehicle has a tow bar but no factory equipped trailer tow module, it is recommended to turn the Blind Spot Information System off manually. Operating the Blind Spot Information System with a trailer attached will cause poor system performance.*

System Errors

If the system senses a problem with the left or right sensor, the telltale will illuminate and a message will appear in the information display. See **Information Messages** (page 118).

Switching the System Off and On

You can temporarily switch the Blind Spot Information System off in the information display. See **General Information** (page 103). When the Blind Spot Information System switches off, you will not receive alerts and the information display shows a system off message. The telltale in the cluster also illuminates. When you switch the Blind Spot Information System on or off, the alert indicators flash twice.

Note: *The Blind Spot Information System remembers the last selected on or off setting.*

You can also have the Blind Spot Information System switched off permanently at an authorized dealer. Once switched off permanently, the system can only be switched back on at an authorized dealer.

CROSS TRAFFIC ALERT

WARNING



To help avoid personal injury, NEVER use the Cross Traffic Alert system as a replacement for using the interior and exterior mirrors and looking over your shoulder before backing out of a parking space. Cross Traffic Alert is not a replacement for careful driving.

Cross Traffic Alert is designed to warn you of vehicles approaching from the sides when the transmission is in reverse (R).

Using the System

Cross Traffic Alert turns on when you start the engine and you shift into reverse (R). Once shifted out of reverse (R), Cross Traffic Alert turns off.

Note: *Cross Traffic Alert only functions while your transmission is in reverse (R).*

Driving Aids

Cross Traffic Alert is designed to detect vehicles that approach with a speed up to 37 mph (60 km/h). Coverage decreases when the sensors are partially, mostly or

fully obstructed. Reversing slowly helps increase the coverage area and effectiveness.

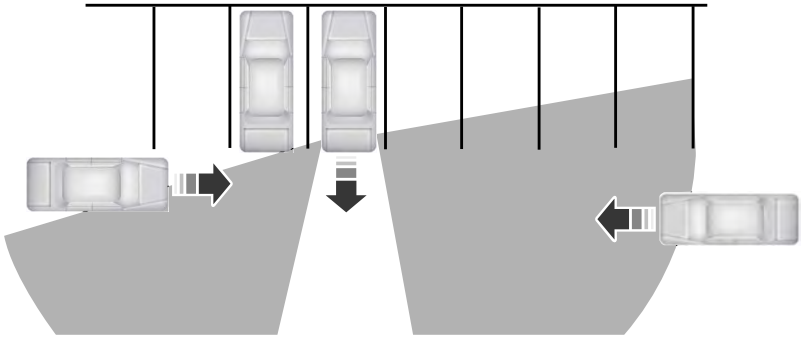

E142440

In this first example, the left sensor is only partially obstructed; zone coverage to the right is nearly maximized.

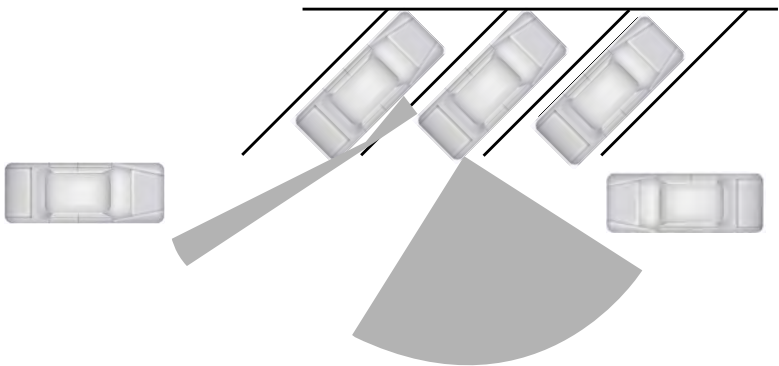

E142441

Driving Aids

Zone coverage also decreases when parking at shallow angles. Here, the left sensor is mostly obstructed; zone coverage on that side is severely limited.

System Lights, Messages and Audible Alerts



E142442

The Cross Traffic Alert illuminates an amber alert indicator in the outside mirror on the side of your vehicle the approaching vehicle is coming from. Cross Traffic Alert also sounds an audible alert and a message appears in the information display indicating a vehicle is coming from the right or left. Cross Traffic Alert works with the reverse sensing system that sounds its own series of tones. See **Parking Aid** (page 201).

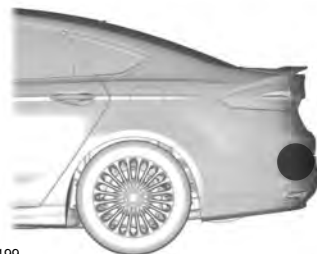

E205199

The system uses radar sensors that are located behind the bumper fascia on each side of your vehicle. Do not allow mud, snow or bumper stickers to obstruct these areas, this can cause degraded system performance. See **Blind Spot Information System** (page 224). If the Blind Spot Information System is blocked, Cross Traffic Alert is also blocked. A corresponding message appears in the information display as soon as you shift the transmission into reverse (R).

System Limitations

Cross Traffic Alert has its limitations; situations such as severe weather conditions or debris build-up on the sensor area may limit vehicle detection.

Driving Aids

The following are other situations that may limit the Cross Traffic Alert performance:

- Adjacently parked vehicles or objects obstructing the sensors.
- Approaching vehicles passing at speeds greater than 37 mph (60 km/h).
- Driving in reverse faster than 7 mph (12 km/h).
- Backing out of an angled parking spot.

False Alerts

Note: *If your vehicle has a tow bar with a factory equipped trailer tow module and it is towing a trailer, the sensors will automatically turn the Cross Traffic Alert off. If your vehicle has a tow bar but no factory equipped trailer tow module, it is recommended to turn the Cross Traffic Alert off manually. Operating Cross Traffic Alert with a trailer attached will cause poor Cross Traffic Alert performance.*

There may be certain instances when there is a false alert by the Cross Traffic Alert system that illuminates the alert indicator with no vehicle in the coverage zone. Some amount of false alerts are normal; they are temporary and self-correct.

System Errors

If Cross Traffic Alert senses a problem with the left or right sensor a message will appear in the information display. See **Information Messages** (page 118).

Switching the System Off and On

You can temporarily switch Cross Traffic Alert off in the information display. See **General Information** (page 103). When you switch Cross Traffic Alert off, you will not receive alerts and the information display will display a system off message.

Note: *The Cross Traffic Alert switches on whenever the ignition is switched on and ready to provide appropriate alerts when the transmission is in reverse (R). Cross Traffic Alert will not remember the last selected on or off setting.*

You can also have Cross Traffic Alert switched off permanently at an authorized dealer. Once switched off permanently, the system can only be switched back on at an authorized dealer.

STEERING

Electric Power Steering

WARNINGS



The electric power steering system has diagnostic checks that continuously monitor the system. If a fault is detected, a message displays in the information display. Stop your vehicle as soon as it is safe to do so. Switch the ignition off. After at least 10 seconds, switch the ignition on and watch the information display for a steering system warning message. If a steering system warning message returns, have the system checked by an authorized dealer.



If the system detects an error, you may not feel a difference in the steering, however a serious condition may exist. Obtain immediate service from an authorized dealer, failure to do so may result in loss of steering control.

Your vehicle has an electric power steering system. There is no fluid reservoir. No maintenance is required.

If your vehicle loses electrical power while you are driving, electric power steering assistance is lost. The steering system still operates and you can steer your vehicle manually. Manually steering your vehicle requires more effort.

Driving Aids

Extreme continuous steering may increase the effort required for you to steer your vehicle. This increased effort prevents overheating and permanent damage to the steering system. You do not lose the ability to steer your vehicle manually. Typical steering and driving maneuvers allow the system to cool and return to normal operation.

Steering Tips

If the steering wanders or pulls, check for:

- Correct tire pressures.
- Uneven tire wear.
- Loose or worn suspension components.
- Loose or worn steering components.
- Improper vehicle alignment.

Note: A high crown in the road or high crosswinds may also make the steering seem to wander or pull.

Adaptive Learning

The electronic power steering system adaptive learning helps correct road irregularities and improves overall handling and steering feel. It communicates with the brake system to help operate advanced stability control and accident avoidance systems. Additionally, whenever the battery is disconnected or a new battery installed, you must drive your vehicle a short distance before the system relearns the strategy and reactivates all systems.

COLLISION WARNING SYSTEM

(If Equipped)

Principle Of Operation (If Equipped)

WARNINGS



This system is an extra driving aid. It does not replace your attention and judgment, or the need to apply the brakes. This system does NOT automatically brake your vehicle. If you fail to press the brake pedal when necessary, you may collide with another vehicle.



The collision warning system with brake support cannot help prevent all collisions. Do not rely on this system to replace your judgment and the need to maintain correct distance and speed.

Note: The system does not detect, warn or respond to potential collisions with vehicles to the rear or sides of your vehicle.

Note: The collision warning system is active at speeds above approximately 5 mph (8 km/h).

Note: The collision warning system will be unavailable if you disable the electronic stability control. See **Using Stability Control** (page 197).



E156130

The system alerts you of certain collision risks. The system's sensor detects your vehicle's rapid approach to other vehicles traveling in the same direction as your vehicle.

Driving Aids

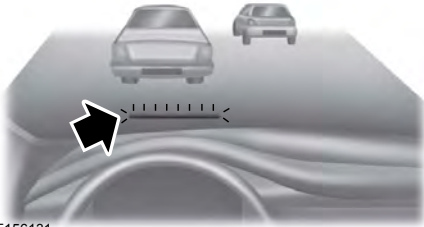

E156131

When your vehicle rapidly approaches another vehicle, a red warning light flashes and a tone sounds.

The brake support system assists you in reducing any collision speed by pre-charging the brakes. If the risk of collision continues to increase after the audio-visual warning, the brake support prepares the brake system for rapid braking. The system does not automatically activate the brakes, but if the brake pedal is pressed even lightly, the brakes apply full stopping power.

Using the Collision Warning System

WARNING



The collision warning system's brake support reduces collision speed only if you brake your vehicle before any collision. As in any typical braking situation, you must press your brake pedal.

You can use your information display control to adjust the collision warning system's sensitivity or to turn the system On or Off. Your vehicle will remember these settings across key cycles. You may change the collision warning system sensitivity to any one of three possible settings. See **General Information** (page 103).

Note: It is recommended that you turn the collision warning system off if a snow plow or similar object is installed in such a way that it may block the radar sensor. Your vehicle will remember the selected setting across key cycles.

Note: When possible, the manufacturer recommends using the highest sensitivity setting. If warnings are too frequent, you can reduce your system's sensitivity. Reduced sensitivity causes fewer and later system warnings. See **General Information** (page 103).

Blocked Sensors

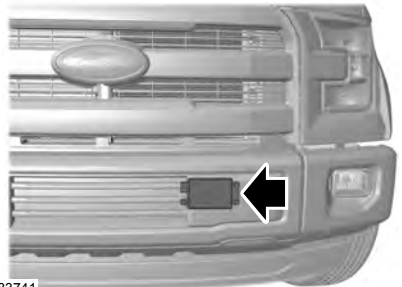

E183741

If a blocked sensor message appears in the information display, dirt, water, or an object is blocking the sensor. The sensor is located behind a cover near the driver side of the lower grille. If anything blocks the sensor, your vehicle cannot see through the sensor, and the collision warning system will not work. Possible causes for the blocked sensor message and corrective actions are listed below.

Driving Aids

Cause	Action
The radar sensor cover in the grille is dirty or obstructed	Clean the radar sensor cover or remove the obstruction
The surface of the radar sensor cover is clean but the message remains in the display	Wait a short time. The radar may take several minutes to reset after you remove the obstruction
Heavy rain, spray, snow or fog in the air interferes with the radar signals	The collision warning system is temporarily disabled. Shortly after weather conditions improve, the collision warning system automatically reactivates
Swirling water, snow or ice on the road surface interferes with the radar signals	The collision warning system is temporarily disabled. Shortly after weather conditions improve, the collision warning system automatically reactivates

System Limitations

WARNING



The collision warning system's brake support only reduces collision speed if you first apply your brakes. You must brake as you would in any typical braking situation.

Damage to the front end of your vehicle may alter the radar sensor's coverage area. This may result in missed or false collision warnings. Have an authorized dealer check your radar sensor for proper coverage and operation.

Due to the nature of radar technology, there may be certain instances where vehicles do not provide a collision warning. These include:

- Stationary vehicles or vehicles moving below 6 mph (10 km/h).
- Pedestrians or objects in the roadway.
- Oncoming vehicles in the same lane.
- Severe weather conditions (see blocked sensor section).
- Debris build-up on the grille near the headlamps (see blocked sensor section).
- Small distance to vehicle ahead.
- Large steering wheel and pedal movements (very active driving style).

Load Carrying

LOAD LIMIT

Vehicle Loading - with and without a Trailer

This section will guide you in the proper loading of your vehicle, trailer or both, to keep your loaded vehicle weight within its design rating capability, with or without a trailer. Properly loading your vehicle will provide maximum return of vehicle design performance. Before loading your vehicle, familiarize yourself with

the following terms for determining your vehicle's weight ratings, with or without a trailer, from the vehicle's Tire Label or Safety Compliance Certification Label:

Base Curb Weight - is the weight of the vehicle including a full tank of fuel and all standard equipment. It does not include passengers, cargo, or optional equipment.

Vehicle Curb Weight - is the weight of your new vehicle when you picked it up from your authorized dealer plus any aftermarket equipment.

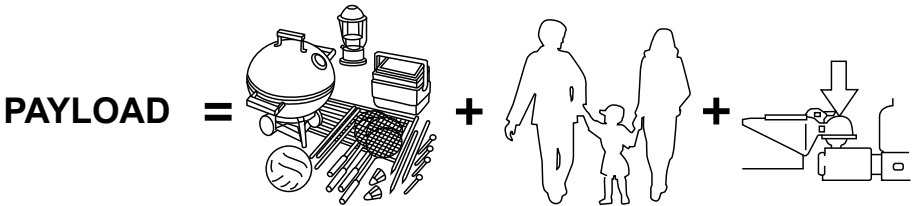

E143816

Payload - is the combined weight of cargo and passengers that the vehicle is carrying. The maximum payload for your vehicle can be found on the Tire Label on the B-Pillar or the edge of the driver door (vehicles exported outside the US and Canada may not have a Tire Label). Look for **“THE COMBINED WEIGHT OF OCCUPANTS AND CARGO SHOULD NEVER EXCEED XXX**

kg OR XXX lb.” for maximum payload. The payload listed on the Tire Label is the maximum payload for the vehicle as built by the assembly plant. If you install any aftermarket or authorized-dealer installed equipment on the vehicle, you must subtract the weight of the equipment from the payload listed on the Tire Label in order to determine the new payload.

Load Carrying

WARNING



The appropriate loading capacity of your vehicle can be limited either by volume capacity (how much space is available) or by payload capacity (how much weight the vehicle should carry). Once you have reached the maximum payload of your vehicle, do not add more cargo, even if there is space available. Overloading or improperly loading your vehicle can contribute to loss of vehicle control and vehicle rollover.

Example only:

TIRE AND LOADING INFORMATION			
SEATING CAPACITY	TOTAL 5	FRONT 2	REAR 3
The combined weight of occupants and cargo should never exceed : XXX kg or XXX lbs.			
TIRE	SIZE	COLD TIRE PRESSURE	SEE OWNERS MANUAL FOR ADDITIONAL INFORMATION
FRONT	LT225/75R16.5E	200 KPA, 29 PSI	
REAR	LT225/75R16.5E	200 KPA, 29 PSI	
SPARE	T145/80D16 P225/60R17	420 KPA, 60 PSI 200 KPA, 29 PSI	

E210944

TIRE AND LOADING INFORMATION			
RENSEIGNEMENTS SUR LES PNEUS ET LE CHARGEMENT			
SEATING CAPACITY	TOTAL 5	FRONT 2	REAR 3
The combined weight of occupants and cargo should never exceed 492 kg or 1085 lbs.			
Le poids total des occupants et du chargement ne doit jamais dépasser 492 kg ou 1085 lbs.			
TIRE PNEU	SIZE DIMENSIONS	COLD TIRE PRESSURE PRESSION DES PNEUS A FROID	SEE OWNERS MANUAL FOR ADDITIONAL INFORMATION VOIR LE MANUEL DE L'USAGER POUR PLUS DE RENSEIGNEMENTS
FRONT AVANT	P235/70R16	240 KPA, 35 PSI	
REAR ARRIERE	P235/70R16	240 KPA, 35 PSI	
SPARE DE SECOURS	T145/90R17	415 KPA, 60 PSI	

E210945

CARGO

=



+

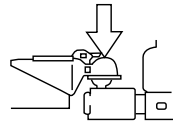

E143817

Load Carrying

Cargo Weight - includes all weight added to the Base Curb Weight, including cargo and optional equipment. When towing, trailer tongue load or king pin weight is also part of cargo weight.

GAW (Gross Axle Weight) - is the total weight placed on each axle (front and rear) including vehicle curb weight and all payload.

GAWR (Gross Axle Weight Rating) - is the maximum allowable weight that can be carried by a single axle (front or rear). These numbers are shown on the Safety Compliance

Certification Label. The label shall be affixed to either the door hinge pillar, door-latch post, or the door edge that meets the door-latch post, next to the driver seating position. **The total load on each axle must never exceed its Gross Axle Weight Rating.**

Note: For trailer towing information refer to the *RV and Trailer Towing Guide* available at an authorized dealer.

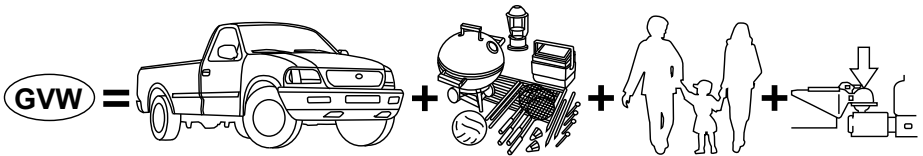

E143818

GVW (Gross Vehicle Weight) - is the Vehicle Curb Weight, plus cargo, plus passengers.

GVWR (Gross Vehicle Weight Rating) - is the maximum allowable weight of the fully loaded vehicle (including all options, equipment, passengers and cargo). It is shown on the

Safety Compliance Certification Label. The label shall be affixed to either the door hinge pillar, door-latch post, or the door edge that meets the door-latch post, next to the driver seating position. **The Gross Vehicle Weight must never exceed the Gross Vehicle Weight Rating.**

Load Carrying

Example only:

MFD. BY FORD MOTOR CO.

DATE: XX/XX	GVWR: XXXX KG (XXXX LB)	
FRONT GAWR:	REAR GAWR:	
XXXX KG (XXXX LB)	WITH XXXX KG (XXXX LB)	WITH
XXXXXXXXXXXXXXXXXX	TIRES XXXXXXXXXXXXXXXX	TIRES
XXXXXXXX	RIMS XXXXXXXX	RIMS
AT XXXX kPa/ XXX PSI COLD	AT XXXX kPa/ XXX PSI COLD	

THIS VEHICLE CONFORMS TO ALL APPLICABLE FEDERAL MOTOR VEHICLE SAFETY AND THEFT PREVENTION STANDARDS IN EFFECT ON THE DATE OF MANUFACTURE SHOWN ABOVE.

VIN: XXXXXXXXXXXXXXXXXXXX



TYPE: XXXX



EXT PNT:	XX	XXXXXX	RC:	XX	DSO:	XXXX	
WB	INT TR	TP/PS	R	AXLE	TR	SPR	XXXX
XXX	XX	XXX	X	XX	X	XXXX	XXXX
XXXXXXXXXXXXXXXX		XXX		XXXX-XXXXXXXX-XX			

MFD. BY FORD MOTOR CO.

DATE: xx/xx	GVWR/PNBV: xxxxx LB/xxxxx KG	
FRONT GAWR/PNBE AV	REAR GAWR/PNBE AR	
xxxxx/xxxxx B	xxxxx KG/xxxxx B	
WITH/AVEC TIRES/PNEUS		
xxxxx/xxxxx	xxxxx/xxxxx	
xxxxx/xxxxx	RIMS/JANTES xxxxxxx	
AT/A kPa/PSI/LPC	xxx/xx	COLD/A FROID
		xxxx/xx
VIN: xxxxxxxxxxxxxxxxxxxx		/JUMEELES
TYPE: xxx/xxxx	COMPLIES: xxxxx/xxxx-xxxx	xxxxxx
		xxxxxx

EXT PNT:	U		RC:	xx	DSO:		
WB	INT TR	TP/PS	R	AXLE	TR	SPR	xxxxxx
xxx	xx		x	xx	x	xxxx	xxx
XXXXXXXXXXXXXXXX		xxx		xxxx-xxxxxxxx-xx			

E198828

WARNING

 Exceeding the Safety Compliance Certification Label vehicle weight rating limits could result in substandard vehicle handling or performance, engine, transmission and/or structural damage, serious damage to the vehicle, loss of control and personal injury.

GCW
=
GVW
+

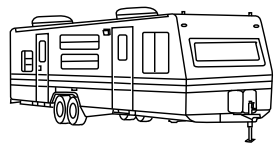

E143819

Load Carrying

GCW (Gross Combined Weight)

- is the Gross Vehicle Weight plus the weight of the fully loaded trailer.

GCWR (Gross Combined Weight Rating)

- is the maximum allowable weight of the vehicle and the loaded trailer, including all cargo and passengers, that the vehicle can handle without risking damage. (Important: The towing vehicle's braking system is rated for operation at Gross Vehicle Weight Rating, not at Gross Combined Weight Rating.)

Separate functional brakes should be used for safe control of towed vehicles and for trailers where the Gross Combined Weight of the towing vehicle plus the trailer exceed the Gross Vehicle Weight Rating of the towing vehicle. **The Gross Combined Weight must never exceed the Gross Combined Weight Rating.**

Maximum Loaded Trailer Weight

- is the highest possible weight of a fully loaded trailer the vehicle can tow. It assumes a vehicle with mandatory options, driver and front passenger weight (150 pounds [68 kilograms] each), no cargo weight (internal or external) and a tongue load of 10–15% (conventional trailer) or king pin weight of 15–25% (fifth wheel trailer). Consult an authorized dealer (or the RV and Trailer Towing Guide available at an authorized dealer) for more detailed information.

Tongue Load or Fifth Wheel King Pin Weight

- refers to the amount of the weight that a trailer pushes down on a trailer hitch.

Examples: For a 5000 pound (2268 kilogram) conventional trailer, multiply 5000 by 0.10 and 0.15 to obtain a proper tongue load range of 500 to 750 pounds (227 to 340 kilograms). For an 11500 pound (5216 kilogram) fifth wheel trailer, multiply by 0.15 and 0.25 to obtain a proper king pin load range of 1725 to 2875 pounds (782 to 1304 kilograms).

WARNINGS



Do not exceed the GVWR or the GAWR specified on the Safety Compliance Certification Label.



Do not use replacement tires with lower load carrying capacities than the original tires because they may lower the vehicle's GVWR and GAWR limitations. Replacement tires with a higher limit than the original tires do not increase the GVWR and GAWR limitations.



Exceeding any vehicle weight rating limitation could result in serious damage to the vehicle and/or personal injury.

Steps for determining the correct load limit:

Load Carrying

1. Locate the statement "The combined weight of occupants and cargo should never exceed XXX kg or XXX lb." on your vehicle's placard.
2. Determine the combined weight of the driver and passengers that will be riding in your vehicle.
3. Subtract the combined weight of the driver and passengers from XXX kg or XXX lb.
4. The resulting figure equals the available amount of cargo and luggage load capacity. For example, if the "XXX" amount equals 1,400 lb. and there will be five 150 lb. passengers in your vehicle, the amount of available cargo and luggage load capacity is 650 lb. ($1400 - 750 (5 \times 150) = 650$ lb.).
5. Determine the combined weight of luggage and cargo being loaded on the vehicle. That weight may not safely exceed the available cargo and luggage load capacity calculated in Step 4.
6. If your vehicle will be towing a trailer, load from your trailer will be transferred to your vehicle. Consult this manual to determine how this reduces the available cargo and luggage load capacity of your vehicle.

The following gives you a few examples on how to calculate the available amount of cargo and luggage load capacity:

*Suppose your vehicle has a 1400-pound (635-kilogram) cargo and luggage capacity. You decide to go golfing. Is there enough load capacity to carry you, four of your friends and all the golf bags? You and four friends average 220 pounds (99 kilograms) each and the golf bags weigh approximately 30 pounds (13.5 kilograms) each. The calculation would be: $1400 - (5 \times 220) - (5 \times 30) = 1400 - 1100 - 150 = 150$ pounds. Yes, you have enough load capacity in your vehicle to transport four friends and your golf bags. In metric units, the calculation would be: $635 \text{ kilograms} - (5 \times 99 \text{ kilograms}) - (5 \times 13.5 \text{ kilograms}) = 635 - 495 - 67.5 = 72.5$ kilograms.

*Suppose your vehicle has a 1400-pound (635-kilogram) cargo and luggage capacity. You and one of your friends decide to pick up cement from the local home improvement store to finish that patio you have been planning for the past two years. Measuring the inside of the vehicle with the rear seat folded down, you have room for twelve 100-pound (45-kilogram) bags of cement. Do you have enough load capacity to transport the cement to your home? If you and your friend each weigh 220 pounds (99 kilograms), the calculation would be: $1400 - (2 \times 220) - (12 \times 100) = 1400 - 440 - 1200 = -240$ pounds. No, you do not have enough cargo capacity to carry that much weight. In metric units, the calculation would

Load Carrying

be: 635 kilograms - (2 x 99 kilograms) - (12 x 45 kilograms) = 635 - 198 - 540 = -103 kilograms. You will need to reduce the load weight by at least 240 pounds (104 kilograms). If you remove three 100-pound (45-kilogram) cement bags, then the load calculation would be: 1400 - (2 x 220) - (9 x 100) = 1400 - 440 - 900 = 60 pounds. Now you have the load capacity to transport the cement and your friend home. In metric units, the calculation would be: 635 kilograms - (2 x 99 kilograms) - (9 x 45 kilograms) = 635 - 198 - 405 = 32 kilograms.

The above calculations also assume that the loads are positioned in your vehicle in a manner that does not overload the Front or the Rear Gross Axle Weight Rating specified for your vehicle on the Safety Compliance Certification Label. The label shall be affixed to either the door hinge pillar, door-latch post, or the door edge that meets the door-latch post, next to the driver seating position.

Special Loading Instructions for Owners of Pick-up Trucks and Utility-type Vehicles

WARNING

 Loaded vehicles may handle differently than unloaded vehicles. Extra precautions, such as slower speeds and increased stopping distance, should be taken when driving a heavily loaded vehicle.

Your vehicle can haul more cargo and people than most passenger cars. Depending upon the type and placement of the load, hauling cargo and people may raise the center of gravity of the vehicle.

TAILGATE

Tailgate Lock (If Equipped)

The tailgate lock can help prevent tailgate theft.

Manual Tailgate Lock

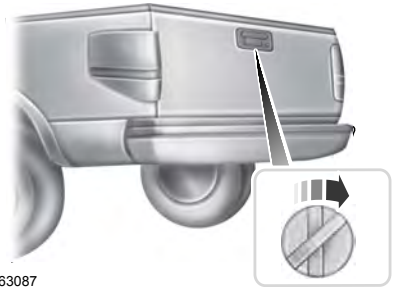

E163087

Load Carrying

Insert the ignition key into the tailgate lock. Turn it clockwise to lock the tailgate. Turn it counterclockwise to unlock the tailgate.

Remote Control Tailgate Lock (If Equipped)

Use the lock and unlock buttons on your remote control to lock and unlock the tailgate.

Manual Tailgate Opening

Manual Tailgate Release



E187692

1. Unlock the tailgate.
2. Pull up on the manual tailgate handle to release the tailgate.

Electronic Tailgate Opening (If Equipped)

WARNING



It is extremely dangerous to ride in a cargo area, inside or outside of a vehicle. In a crash, people riding in these areas are more likely to be seriously injured or killed. Do not allow people to ride in any area of your vehicle that is not equipped with seats and safety belts. Make sure everyone in your vehicle is in a seat and properly using a safety belt. Failure to follow this warning could result in serious personal injury or death.

The electronic tailgate release will not operate when:

- The battery voltage is below the minimum operating voltage.
- The vehicle speed is at or above 3 mph (5 km/h).

With the Remote Control



Press the remote control button twice within three seconds.

With the Outside Control Button

1. Unlock the vehicle with the remote control or power door unlock control. If an intelligent access transmitter is within 3 ft (1 m) of the tailgate, the tailgate will unlock when you press the tailgate release button.



E187693

2. Press the button in the top of the tailgate handle.
3. Push the tailgate up to close the tailgate.

Note: The electronic tailgate is not a powered tailgate. The use of a tonneau cover or other aftermarket accessories, freezing conditions or being parked downhill may stop your tailgate from opening automatically after it is unlatched. You may need to pull the handle to open the tailgate if the tailgate does not automatically lower after being unlatched.

Load Carrying

Tailgate Removal

WARNING



Always properly secure cargo to prevent shifting cargo or cargo falling from vehicle, which could result in compromised vehicle stability and serious personal injury to vehicle occupants or others.

You can remove the tailgate for more loading room.

Note: Skip to Step 4 if your vehicle does not have a rearview camera.

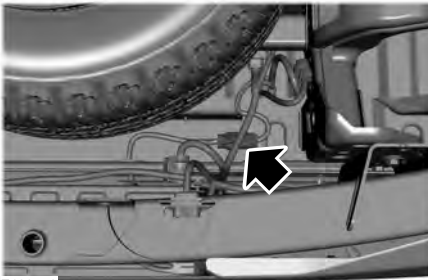

E189556

1. Locate and disconnect the rearview camera in-line connector. It is under the pickup box on the right-hand side of the vehicle near the spare tire.
2. There is a protective cap in the glove box. Install it on the in-line connector that remains under the pickup box.
3. Partially lower the tailgate. Carefully feed the tailgate harness up through the gap between the pickup box and the bumper and place it out of the way under the pickup box.
4. Lower the tailgate.

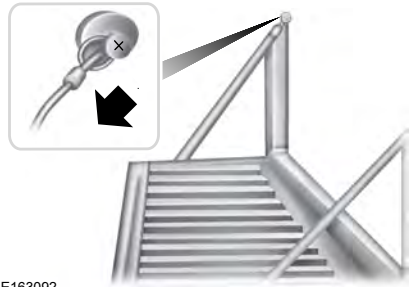

E163092

5. Use a screwdriver to gently pry the spring clip on each connector past the head of the support screw. Disconnect the cable.
6. Disconnect the other cable.
7. Lift the tailgate to 45° from horizontal.
8. Lift the right side off its hinge.
9. Lift the tailgate to 80° from horizontal.
10. Remove the tailgate from the left side hinge by sliding it to the right.

Reverse the steps to reinstall the tailgate.

Tailgate Step (If Equipped)

Use the step to make entering the truck bed easier.

To reduce the risk of falling:

- Only operate the step when your vehicle is on a level surface.
- Only operate the step in areas with sufficient lighting.
- Always open the step panel to widen the step.
- Always use the grab handle when climbing on the step.
- Do not use the step with bare feet.
- Make sure the step is clean before use.
- Keep the step load, you plus the load, below 350 lb (159 kg).

Load Carrying

Opening the Step

Note: Make sure to close and fully latch the step before moving your vehicle. Never drive with the step or grab handle open.

1. Lower the tailgate.
2. Push the button in the center of the step molding. The step will pop out slightly.

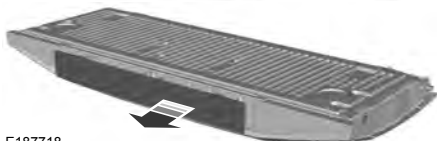

E187718

3. Pull the step out fully. Lower the step to its lowest position.



E189557

4. Pull the yellow handle stop backward out of the tailgate.
5. Rotate the handle up from horizontal to vertical until you hear a click. You have locked the handle in place.

Note: Do not tow with the step or grab the handle.

Replace the slip resistance tape or grab handle molding if it appears worn or damaged.

Closing the Step

1. Press handle button 1 to lower the telescoping handle extension, and then press button 2 to release the handle. Rotate the handle down from vertical to horizontal.
2. Push the handle back into the tailgate.
3. Rotate the step up until it is horizontal, then push it back into the tailgate, until the step is secure.

Box Side Step (If Equipped)

Use the step for easier access to the truck bed.

Note: Close the step before driving.

Note: Do not exceed 500 lb (227 kg) on the step. This includes you plus cargo.

Note: Do not use the step to lift the vehicle. Only use proper jacking points.

Note: The step may operate more slowly in cool temperatures.

Note: The step mechanism may trap debris such as mud, dirt, snow, ice and salt. This may prevent the step from deploying automatically when you press the button. If this happens, make sure that you press the button down and carefully pull out the step manually. Wash off the debris with a high-pressure car wash wand and stow the step.

Load Carrying

Deploying the Step

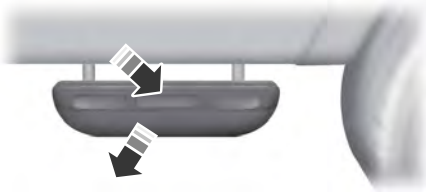

E167268

Push down on the button with your foot. The step will automatically extend from the stowed position.

Stowing the Step



E167269

Push the step under the truck with your foot until it fully latches. Do not push on the button while stowing the step.

Bed Extender (If Equipped)

Note: Do not use the bed extender when driving off road.

Note: Make sure to engage the locking pins and knobs fully before driving your vehicle.

Note: Make sure to secure all cargo.

Note: Do not exceed 150 lb (68 kg) on the tailgate when your vehicle is moving.

Note: Do not keep the bed extender in the tailgate mode when you are not using it for restraining cargo. Always keep the bed extender in the grocery mode or the stowed position with the tailgate closed.

Tailgate Mode



E163095

1. Pull the locking pin toward the center of your vehicle.



E163096

2. Open the latches to release the panels.

Load Carrying



E163097

3. Rotate the panels toward the tailgate. Repeat Steps 1-3 on the other side of your vehicle.



E163098

4. Connect the two panels. Rotate both knobs one-quarter turn clockwise to secure the panels.

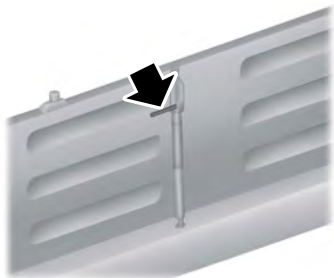

E163099

5. Make sure to insert the latch rod into the tailgate hole. Make sure to engage both sides of the locking pins into their holes in the pick-up box.

Reverse the steps to store the bed extender.

Grocery Mode



E163100

Follow Steps 1-4 of the tailgate mode instructions by rotating the panels away from the tailgate. Close the tailgate.

BoxLink™ Cleats (If Equipped)

These cleats attach to the inner box walls to help you to tie down cargo. The cleats can be locked to prevent removal or unlocked for removal.

BoxLink Cleats

Note: Leave the key in the lock when removing or installing the cleats. The key cannot be removed from the lock unless it is in the locked position.

Load Carrying

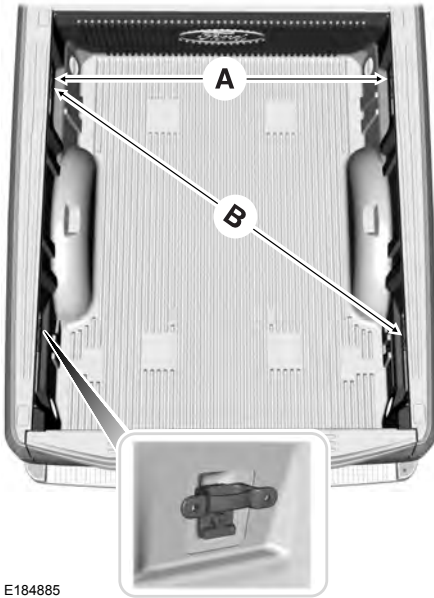

E184885

A. 275 lb (1,223 N) maximum force between directly opposed cleats.

B. 600 lb (2,669 N) maximum force between diagonally opposed cleats.

Secure cargo with up to 275 lb (1,223 N) force applied between opposing box link cleats, or up to 600 lb (2,669 N) force applied between diagonal box link cleats.

Removing Locking BoxLink Cleats

1. Insert the key into the lock and turn clockwise to unlock.
2. Pull bottom of the cleat outward while pushing top of cleat down.
3. Hold on to the cleat as it clears the mounting slot.

Installing Locking BoxLink Cleats

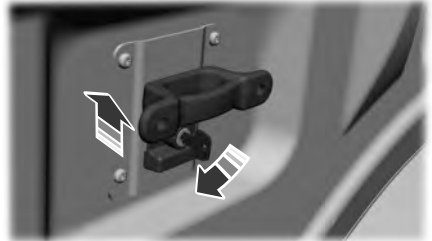

E189558

1. Insert the key into the lock and turn clockwise to unlock.
2. Insert the cleat into the mounting slot and push upward. Make sure the cleat is fully engaged.
3. Turn the key counterclockwise to lock.
4. Remove the key.

Bed Ramp (If Equipped)

WARNINGS





The slide action of the ramp is a pinch point. Do not place fingers or hands in the pinch point.



Extend and retract the ramp only when connected to the tailgate plate.

Load Carrying

WARNINGS

-  Be sure the ramp is installed correctly when loading and unloading equipment on and off the ramp.
-  Do not step or sit on the ramp when it is in the stowed position.
-  Install the ramp only within the prescribed ramp angles.

Note: The ramp maximum capacity is 800 lb (363 kg).

Note: Verify the ramp is on stable ground before usage.

Note: For loading and unloading equipment, your ramp should be set between 10° upward and 26° downward to avoid damage to the ramp claw and tailgate plate.

Using the Bed Ramp

1. Remove the front and rear cables.

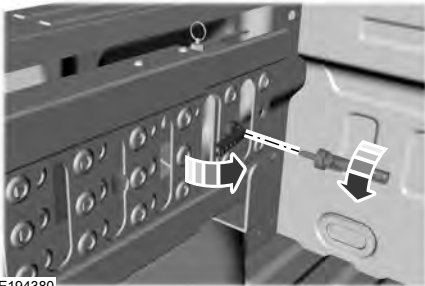

E194380

2. Open the cam lever arms and unscrew the cam bolts.
3. Remove the ramp from the ramp holder.



E211150

Note: A smooth surface tool can be used to rotate the stops.

4. Rotate the stops at the underside of the ramp to the open position.



E194382

5. Slide the ramp claw onto the tailgate plate.

Load Carrying

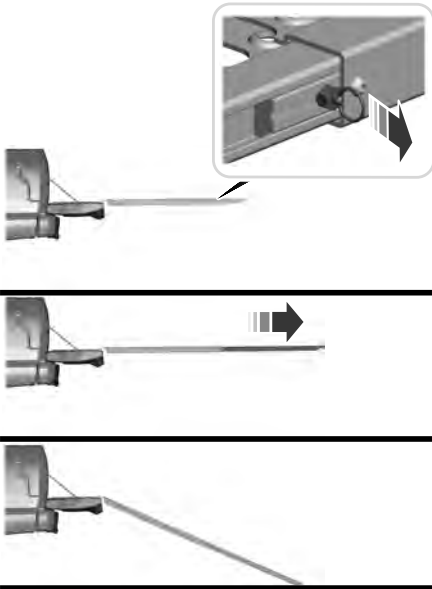

E194383

6. Pull the location pin outward and extend the ramp until the pin is seated in the usage position, then set the ramp on even ground.

Stowing the Bed Ramp

1. Pick up the ramp. Pull the location pin outward.
2. Slide the ramp into the storage position until the location pin locks.

Note: Make sure the proper pin location has been applied for your bed size.

3. Slide the ramp claw off of the tailgate plate.
4. Rotate the stops at the underside of the ramp to the closed position.

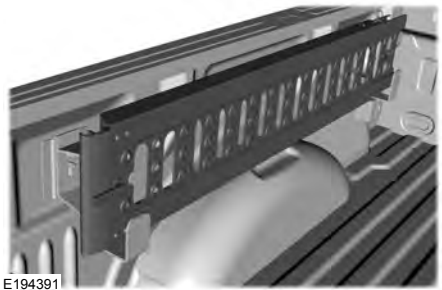

E194391

5. Place the ramp into the ramp holder.
6. Install the cam bolts and close the cam lever arms.
7. Attach the front and rear cables.

Installing the Ramp Holder

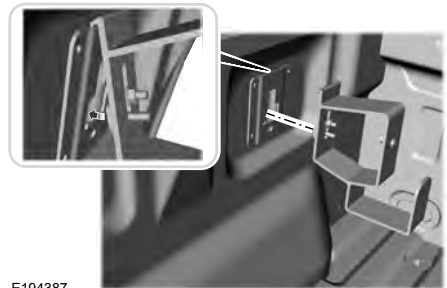

E194387

1. Hook the top of the ramp holder over the mounting plate and rotate the ramp holder into position.

Load Carrying

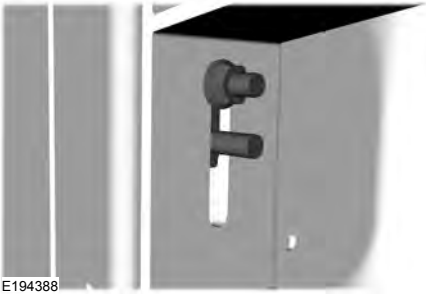

2. Slide the ramp holder studs upwards into the installed position.
3. Tighten the ramp holder nut.

Note: *The nut should be on the upper stud.*

Towing

TOWING A TRAILER

WARNINGS



Do not exceed the GVWR or the GAWR specified on the certification label.



Towing trailers beyond the maximum recommended gross trailer weight exceeds the limit of the vehicle and could result in engine damage, transmission damage, structural damage, loss of vehicle control, vehicle rollover and personal injury.

Your vehicle may have electrical items, such as fuses or relays, related to towing. See **Fuses** (page 289).

Your vehicle's load capacity designation is by weight, not by volume, so you cannot necessarily use all available space when loading a vehicle or trailer.

Towing a trailer places an extra load on your vehicle's engine, transmission, axle, brakes, tires and suspension. Inspect these components periodically during, and after, any towing operation.

Load Placement

To help minimize how trailer movement affects your vehicle when driving:

- Load the heaviest items closest to the trailer floor.
- Load the heaviest items centered between the left and right side trailer tires.
- Load the heaviest items above the trailer axles or just slightly forward toward the trailer tongue. Do not allow the final trailer tongue weight to go above or below 10-15% of the loaded trailer weight.
- Select a ball mount with the correct rise or drop. When both the loaded vehicle and trailer are connected, the trailer frame should be level, or slightly angled down toward your vehicle, when viewed from the side.

When driving with a trailer or payload, a slight takeoff vibration or shudder may be present due to the increased payload weight. Additional information regarding proper trailer loading and setting your vehicle up for towing is located in another chapter of this manual. See **Load Limit** (page 233).

You can also find information in the **RV & Trailer Towing Guide** available at your authorized dealer, or online.

Towing

RV & Trailer Towing Guide Online

Website | <http://www.fleet.ford.com/towing-guides/>

TRAILER SWAY CONTROL (If Equipped)

WARNING



Turning off trailer sway control increases the risk of loss of vehicle control, serious injury or death. Ford does not recommend disabling this feature except in situations where speed reduction may be detrimental (such as hill climbing), the driver has significant trailer towing experience, and can control trailer sway and maintain safe operation.

Note: This feature does not prevent trailer sway, but reduces it once it begins.

Note: This feature cannot stop all trailers from swaying.

Note: In some cases, if vehicle speed is too high, the system may activate multiple times, gradually reducing vehicle speed.

This feature applies your vehicle brakes at individual wheels and, if necessary, reduces engine power. If the trailer begins to sway, the stability control light flashes and the message **TRAILER SWAY REDUCE SPEED** appears in the information display. The first thing to do is slow your vehicle down, then pull safely to the side of the road and check for proper tongue load and trailer load distribution. See **Load Carrying** (page 233).

RECOMMENDED TOWING WEIGHTS

Note: Do not exceed a trailer weight of 5,100 lb (2,313 kg) when towing with, or by, bumper only.

Note: Do not exceed a trailer weight of 5,100 lb (2,313 kg) if your vehicle is not equipped with a Heavy Duty Trailer Towing Package.

Note: Make sure to take into consideration trailer frontal area. Vehicles not equipped with the Trailer Tow Package or the Heavy Duty Payload Package should not exceed 36.6 feet² (3.4 meters²) trailer frontal area. Vehicles equipped with the Trailer Tow Package or the Heavy Duty Payload Package should not exceed 60 feet² (5.6 meters²) trailer frontal area.

Note: Exceeding this limitation may significantly reduce the performance of your towing vehicle. Selecting a trailer with a low aerodynamic drag and rounded front design helps optimize performance and fuel economy.

Towing

Note: For high altitude operation, reduce the gross combined weight by 2% per 1,000 ft (305 m) starting at the 1,000 ft (305 m) elevation point.

Note: Certain states require electric trailer brakes for trailers over a specified weight. Be sure to check state regulations for this specified weight. The maximum trailer weights listed may be limited to this specified weight, as your vehicle's electrical system may not include the wiring connector needed to use electric trailer brakes.

Your vehicle may tow a trailer provided the maximum trailer weight is less than or equal to the maximum trailer weight listed for your vehicle configuration on the following charts.

Driveline – 4x2¹			
Cab – wheel-base (inches)	Engine	Axle ratio	Maximum GCWR^{2,3}
Regular cab – 122	3.5L TiVCT	3.55	9500 lb (4309 kg) ⁴
		3.73	12000 lb (5443 kg)
	2.7L GTDI	3.31	12200 lb (5533 kg)
		3.73	13100 lb (5942 kg)
	5.0L TiVCT	3.31	13000 lb (5897 kg)
		3.55	13800 lb (6260 kg)
Regular cab – 141	3.5L TiVCT	3.55	9600 lb (4354 kg) ⁴

Towing

Driveline – 4x2¹			
Cab – wheel-base (inches)	Engine	Axle ratio	Maximum GCWR^{2,3}
	2.7L GTDI	3.73	12100 lb (5488 kg)
		3.31	12300 lb (5579 kg)
		3.73	13100 lb (5942 kg)
		3.73	13300 lb (6032 kg) ⁵
	5.0L TiVCT	3.31	13900 lb (6305 kg)
		3.55	14900 lb (6758 kg)
		3.73	16000 lb (7257 kg) ⁶
	3.5L GTDI	3.15	15500 lb (7030 kg)
		3.55	17000 lb (7711 kg) ⁷
		3.73	17100 lb (7756 kg) ^{6,7}
	Super Cab – 145	3.5L TiVCT	3.55
3.73			12200 lb (5534 kg)
2.7L GTDI		3.31	12500 lb (5670 kg)

Towing

Driveline – 4x2¹			
Cab – wheel- base (inches)	Engine	Axle ratio	Maximum GCWR^{2,3}
		3.73	13100 lb (5942 kg)
		3.73	13300 lb (6032 kg) ⁵
	5.0L TiVCT	3.31	14200 lb (6441 kg)
		3.55	15200 lb (6895 kg)
	3.5L GTDI	3.15	15800 lb (7167 kg)
		3.55	17100 lb (7756 kg) ⁷
Super Cab – 163	2.7L GTDI	3.31	12600 lb (5715 kg)
		3.73	13100 lb (5942 kg)
		3.73	13300 lb (6032 kg) ⁵
	5.0L TiVCT	3.31	14300 lb (6486 kg)
		3.55	15300 lb (6940 kg)
		3.73	16200 lb (7348 kg)
	3.5L GTDI	3.15	15900 lb (7212 kg)

Towing

Driveline – 4x2¹			
Cab – wheel-base (inches)	Engine	Axle ratio	Maximum GCWR^{2,3}
		3.55	17100 lb (7756 kg) ⁷
		3.73	17100 lb (7756 kg) ^{6,7}
Crew cab – 145	3.5L TiVCT	3.73	12200 lb (5534 kg)
	2.7L GTDI	3.31	12600 lb (5715 kg)
		3.73	13100 lb (5942 kg)
		3.73	13100 lb (5942 kg) ⁵
	5.0L TiVCT	3.31	14200 lb (6441 kg)
		3.55	15200 lb (6895 kg)
	3.5L GTDI	3.15	15800 lb (7167 kg)
		3.55	17000 lb (7711 kg) ⁷
Crew cab – 157	2.7L GTDI	3.31	12600 lb (5715 kg)
		3.73	13100 lb (5942 kg)
		3.73	13300 lb (6032 kg) ⁵

Towing

Driveline – 4x2¹			
Cab – wheel- base (inches)	Engine	Axle ratio	Maximum GCWR^{2,3}
	5.0L TiVCT	3.31	14200 lb (6441 kg)
		3.55	15200 lb (6895 kg)
		3.73	16200 lb (7348 kg) ⁶
	3.5L GTDI	3.15	15900 lb (7212 kg)
		3.55	17100 lb (7756 kg) ⁷
		3.73	17100 lb (7756 kg) ^{6,7}

¹Do not exceed a trailer weight of 5100 pounds (2313 kilograms) unless the vehicle is equipped with the Heavy Duty Trailer Tow package or the MAX Trailer Tow package.

²Calculated with SAE J2807 method.

³Heavy Duty Trailer Tow Payload Package (unless stated otherwise).

⁴Medium Duty Trailer Tow package – 5100 pound (2313 kilogram) maximum trailer weight.

⁵2.7L EcoBoost Payload Package.

⁶Heavy Duty Payload Package.

⁷MAX Trailer Tow Payload Package.

Towing

Driveline – 4x4¹			
Cab – wheel-base (inches)	Engine	Axle ratio	Maximum GCWR^{2,3}
Regular cab – 122	3.5L TiVCT	3.73	12200 lb (5534 kg)
	2.7L GTDI	3.55	12500 lb (5670 kg)
		3.73	13300 lb (6032 kg)
	5.0L TiVCT	3.31, 3.55	13200 lb (5987 kg)
		3.73	14600 lb (6622 kg)
Regular cab – 141	3.5L TiVCT	3.73	12200 lb (5534 kg)
	2.7L GTDI	3.55	12500 lb (5670 kg)
		3.73	13300 lb (6032 kg)
		3.73	13300 lb (6032 kg) ⁴
	5.0L TiVCT	3.31, 3.55	14100 lb (6396 kg)
		3.73	16200 lb (7348 kg)
		3.73	16200 lb (7348 kg) ⁵
	3.5L GTDI	3.31	15800 lb (7167 kg)

Towing

Driveline – 4x4¹			
Cab – wheel-base (inches)	Engine	Axle ratio	Maximum GCWR^{2,3}
		3.55	15800 lb (7167 kg)
		3.55	17100 lb (7756 kg) ⁶
		3.73	17000 lb (7711 kg) ^{5,6}
Super Cab – 145	3.5L TiVCT	3.73	12200 lb (5534 kg)
	2.7L GTDI	3.55	12700 lb (5761 kg)
		3.73	13300 lb (6032 kg)
		3.73	13300 lb (6032 kg) ⁴
	5.0L TiVCT	3.31	14300 lb (6486 kg)
		3.55	14400 lb (6532 kg)
		3.73	16200 lb (7348 kg)
	3.5L GTDI	3.31	16000 lb (7167 kg)
		3.55	16000 lb (7167 kg)
		3.55	16900 lb (7665 kg) ⁶

Towing

Driveline – 4x4¹			
Cab – wheel-base (inches)	Engine	Axle ratio	Maximum GCWR^{2,3}
Super Cab – 163	5.0L TiVCT	3.31	14300 lb (6486 kg)
		3.55	14500 lb (6577 kg)
		3.73	16200 lb (7348 kg)
		3.73	16200 lb (7348 kg) ⁵
	3.5L GTDI	3.31	16200 lb (7348 kg)
		3.55	16200 lb (7348 kg)
		3.55	17100 lb (7756 kg) ⁶
		3.73	17100 lb (7756 kg) ^{5,6}
Crew cab – 145	3.5L TiVCT	3.73	12200 lb (5534 kg)
	2.7L GTDI	3.55	12800 lb (5806 kg)
		3.73	13300 lb (6033 kg)
		3.73	13300 lb (6033 kg) ⁴
	5.0L TiVCT	3.31	14300 lb (6486 kg)

Towing

Driveline – 4x4¹			
Cab – wheel- base (inches)	Engine	Axle ratio	Maximum GCWR^{2,3}
		3.55	14400 lb (6532 kg)
		3.73	16200 lb (7348 kg)
	3.5L GTDI	3.31	16100 lb (7303 kg)
		3.55	16100 lb (7303 kg)
		3.55	16900 lb (7666 kg)
Crew cab – 157	5.0L TiVCT	3.31	14300 lb (6486 kg)
		3.55	14500 lb (6577 kg)
		3.73	16200 lb (7348 kg)
		3.73	16200 lb (7348 kg) ⁵
	3.5L GTDI	3.31	16100 lb (7303 kg)
		3.55	16100 lb (7303 kg)

Towing

Driveline – 4x4 ¹			
Cab – wheel-base (inches)	Engine	Axle ratio	Maximum GCWR ^{2,3}
		3.55	17100 lb (7756 kg) ⁶
		3.73	17000 lb (7711 kg) ^{5,6}

¹Do not exceed a trailer weight of 5100 pounds (2313 kilograms) unless the vehicle is equipped with the Heavy Duty Trailer Tow package or the MAX Trailer Tow package.

²Calculated with SAE J2807 method.

³Heavy Duty Trailer Tow Payload Package (unless stated otherwise).

⁴2.7L EcoBoost Payload Package.

⁵Heavy Duty Payload Package.

⁶MAX Trailer Tow Payload Package.

Calculating the Maximum Loaded Trailer Weight for Your Vehicle

1. Start with the gross combined weight rating for your vehicle model and axle ratio. See the previous charts.
2. Subtract all of the following that apply to your vehicle:
 - Vehicle curb weight.
 - Hitch hardware weight, such as a draw bar, ball, locks or weight distributing hardware.
 - Driver weight.

- Passenger(s) weight.
- Payload, cargo and luggage weight.
- Aftermarket equipment weight.

This equals the maximum loaded trailer weight for this combination.

Note: *The trailer tongue load is considered part of the payload for your vehicle. Reduce the total payload by the final trailer tongue weight.*

Note: *Consult an authorized dealer to determine the maximum trailer weight allowed for your vehicle if you are not sure.*

Towing

ESSENTIAL TOWING CHECKS

Follow these guidelines for safe towing:

- Do not tow a trailer until you drive your vehicle at least 1000 miles (1600 kilometers).
- Consult your local motor vehicle laws for towing a trailer.
- See the instructions included with towing accessories for the proper installation and adjustment specifications.
- Service your vehicle more frequently if you tow a trailer. See your scheduled maintenance information.
- If you use a rental trailer, follow the instructions the rental agency gives you.

See **Load limits** in the Load Carrying chapter for load specification terms found on the tire label and Safety Compliance label and instructions on calculating your vehicle's load.

Remember to account for the trailer tongue weight as part of your vehicle load when calculating the total vehicle weight.

Trailer Towing Connector

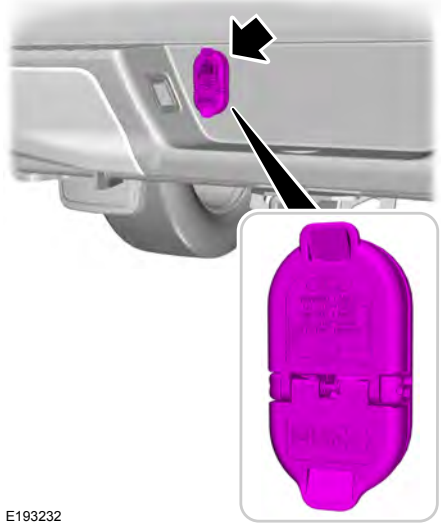

E193232

When attaching the trailer wiring connector to your vehicle, only use a proper fitting connector that works with the vehicle and trailer functions. Some seven-position connectors may have the SAE J2863 logo, which confirms that it is the proper wiring connector and works correctly with your vehicle.

Color	Function
Yellow	Left turn signal and stop lamp
White	Ground (-)
Blue	Electric brakes
Green	Right turn signal and stop lamp

Towing

Color	Function
Orange	Battery (+)
Brown	Running lights
Grey	Reverse lights

Hitches

Do not use a hitch that either clamps onto the bumper or attaches to the axle. You must distribute the load in your trailer so that 10-15% of the total weight of the trailer is on the tongue.

Weight-distributing Hitches

WARNING



Do not adjust a weight-distributing hitch to any position where the rear bumper of the vehicle is higher than it was before attaching the trailer. Doing so will defeat the function of the weight-distributing hitch, which may cause unpredictable handling, and could result in serious personal injury.

When hooking-up a trailer using a weight-distributing hitch, always use the following procedure:

1. Park the loaded vehicle, without the trailer, on a level surface.
2. Measure the height to the top of your vehicle's front wheel opening on the fender. This is H1.
3. Attach the loaded trailer to your vehicle without the weight-distributing bars connected.
4. Measure the height to the top of your vehicle's front wheel opening on the fender a second time. This is H2.

5. Install and adjust the tension in the weight-distributing bars so that the height of your vehicle's front wheel opening on the fender is approximately a quarter the way down from H2, toward H1.
6. Check that the trailer is level or slightly nose down toward your vehicle. If not, adjust the ball height accordingly and repeat Steps 2-6.

Once the trailer is level or slightly nose down toward the vehicle:

- Lock the bar tension adjuster in place.
- Check that the trailer tongue securely attaches and locks onto the hitch.
- Install safety chains, lighting, and trailer brake controls as required by law or the trailer manufacturer.

Safety Chains

Note: Do not attach safety chains to the bumper.

Always connect the safety chains to the frame or hook retainers of your vehicle hitch.

To connect the safety chains, cross the chains under the trailer tongue and allow enough slack for turning tight corners. Do not allow the chains to drag on the ground.

Trailer Brakes

WARNING



Do not connect a trailer's hydraulic brake system directly to your vehicle's brake system. Your vehicle may not have enough braking power and your chances of having a collision greatly increase.

Towing

Electric brakes and manual, automatic or surge-type trailer brakes are safe if you install them properly and adjust them to the manufacturer's specifications. The trailer brakes must meet local and federal regulations.

The rating for the tow vehicle's braking system operation is at the gross vehicle weight rating, not the gross combined weight rating.

Separate functioning brake systems are required for safe control of towed vehicles and trailers weighing more than 1500 pounds (680 kilograms) when loaded.

Integrated Trailer Brake Controller (If Equipped)

WARNING



The Ford trailer brake controller has been verified to be compatible with trailers having electric-actuated drum brakes (one to four axles) and electric-over-hydraulic brakes. It will not activate hydraulic surge-style trailer brakes. It is the responsibility of the customer to ensure that the trailer brakes are adjusted appropriately, functioning normally and all electric connections are properly made. Failure to do so may result in loss of vehicle control, crash or serious injury.

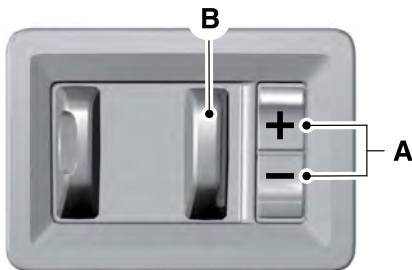

E183395

When used properly, the trailer brake controller assists in smooth and effective trailer braking by powering the trailer's electric or electric-over-hydraulic brakes with a proportional output based on the towing vehicle's brake pressure.

You can adjust the level of initial trailer brake output by selecting one of three settings using the information display. Choose Low, Medium or High for the initial trailer brake output you require. See **Information Displays** (page 103).

The controller user interface consists of the following:

A: + and - (Gain adjustment buttons): Pressing these buttons adjusts the controller's power output to the trailer brakes in 0.5 increments. You can increase the gain setting to 10.0 (maximum trailer braking) or decrease it to 0 (no trailer braking). The gain setting displays in the message center.

The controller shows gain setting, output bar graph, and trailer connectivity status in the information display. They appear in the information display as follows:

- Trailer Brake Controller Gain (without trailer connected): Shows the current gain setting during a given ignition cycle and when adjusting the gain. This also displays if you use the manual control lever or make gain adjustments with no trailer connected.
- Trailer Brake Controller Gain Output: Displays when you push your vehicle's brake pedal, or upon use of the manual control. Bar indicators illuminate in the information display to indicate the amount of power going to the trailer brakes relative to the brake pedal or manual control input. One bar indicates the least amount of output; six bars indicate maximum output.

Towing

- **Trailer Connected:** Displays when the system senses a correct trailer wiring connection (a trailer with electric trailer brakes) during a given ignition cycle.
- **Trailer Disconnected:** Displays, accompanied by a single audible time, when the system senses a trailer connection and then a disconnection, either intentional or unintentional, during a given ignition cycle. It also displays if a truck or trailer-wiring fault occurs causing the trailer to appear disconnected. This message can also display if you use the manual control lever without a trailer connected. After disconnecting the trailer connector, press the brake pedal for approximately five seconds to allow the system to detect and update the trailer status.

B: Manual control lever: Slide the control lever to the left to turn on the trailer's electric brakes independent of the tow vehicle's. See the following **Procedure for adjusting gain** section for instructions on proper use of this feature. If you use the manual control while the brake is also applied, the greater of the two inputs determines the power sent to the trailer brakes.

- **Stop lamps:** Using the manual control lever illuminates both the trailer brake lamps and your vehicle brake lamps except the center high-mount stop lamp, if you make the proper electrical connection to the trailer. Pressing your vehicle brake pedal also illuminates both trailer and vehicle brake lamps.

Procedure for Setting Trailer Brake Controller Mode

Select the correct option using the information display. Choose electric for trailers with electromagnetic drum brakes or EOH for trailers with electric over hydraulic brake systems. See **Information Displays** (page 103).

Trailer Brake Effort Setting

The trailer brake controller allows the user to customize how aggressively the trailer brakes engage. The default value is "Low" and is the recommended setting for most trailers. If your trailer's brakes require more initial voltage, or if you prefer more aggressive trailer braking, then select either the "Medium" or the "High" setting.

Procedure for Adjusting Gain

Note: *Only perform this procedure in a traffic-free environment at speeds of approximately 20-25 mph (30-40 km/h).*

The gain setting sets the trailer brake controller for the specific towing condition. You should change the setting as towing conditions change. Changes to towing conditions include trailer load, vehicle load, road conditions and weather.

The gain should be set to provide the maximum trailer braking assistance while making sure the trailer wheels do not lock when using the brakes. Locked trailer wheels may lead to trailer instability.

1. Make sure the trailer brakes are in good working condition, functioning normally and properly adjusted. See your trailer dealer if necessary.
2. Hook up the trailer and make the electrical connections according to the trailer manufacturer's instructions.

Towing

3. When you plug in a trailer with electric or electric-over-hydraulic brakes, a message confirming connection appears in the information display.
4. Use the gain adjustment (+ and -) buttons to increase or decrease the gain setting to the desired starting point. A gain setting of 6.0 is a good starting point for heavier loads.
5. In a traffic-free environment, tow the trailer on a dry, level surface at a speed of 20-25 mph (30-40 km/h) and squeeze the manual control lever completely.
6. If the trailer wheels lock up, indicated by squealing tires, reduce the gain setting. If the trailer wheels turn freely, increase the gain setting. Repeat Steps 5 and 6 until the gain setting is at a point just below trailer wheel lock-up. If towing a heavier trailer, trailer wheel lock-up may not be attainable even with the maximum gain setting of 10.

Explanation of Information Display Warning Messages

Note: *An authorized dealer can diagnose the trailer brake controller to determine exactly which trailer fault has occurred. However, your Ford warranty does not cover this diagnosis if the fault is with the trailer.*

A message indicating a trailer brake module fault may display in response to faults sensed by the trailer brake controller, accompanied by a single tone. If this message appears, contact an authorized dealer as soon as possible for diagnosis and repair. The controller may still function, but performance may be degraded.

A message indicating a trailer wiring fault may display when there is a short circuit on the electric brake output wire. If this message displays, accompanied by a single tone, with no trailer connected, the problem is with your vehicle wiring between the trailer brake controller and the 7-pin connector at the bumper. If the message only displays with a trailer connected, the problem is with the trailer wiring. Consult your trailer dealer for assistance. This can be a short to ground (such as a chaffed wire), short to voltage (such as a pulled pin on trailer emergency breakaway battery) or the trailer brakes may be drawing too much current.

Points to Remember

Note: *Do not attempt removal of the trailer brake controller without consulting the Workshop Manual. Damage to the unit may result.*

- Adjust gain setting before using the trailer brake controller for the first time.
- Adjust gain setting, using the procedure above, whenever road, weather and trailer or vehicle loading conditions change from when the gain was initially set.
- Only use the manual control lever for proper adjustment of the gain during trailer setup. Misuse, such as application during trailer sway, could cause instability of trailer or tow vehicle.
- Avoid towing in adverse weather conditions. The trailer brake controller does not provide anti-lock control of the trailer wheels. Trailer wheels can lock up on slippery surfaces, resulting in reduced stability of trailer and tow vehicle.

Towing

- The trailer brake controller is equipped with a feature that reduces output at vehicle speeds below 11 mph (18 km/h) so trailer and vehicle braking is not jerky or harsh. This feature is only available when applying the brakes using your vehicle's brake pedal, not the controller.
- The controller interacts with the brake control system and powertrain control system of your vehicle to provide the best performance on different road conditions.
- Your vehicle's brake system and the trailer brake system work independently of each other. Changing the gain setting on the controller does not affect the operation of your vehicle's brakes whether you attach a trailer or not.
- When you switch the engine off, the controller output is disabled and the display and module shut down. The controller module and display turn on when you switch the ignition on.
- The trailer brake controller is only a factory-installed or dealer-installed item. Ford is not responsible for warranty or performance of the controller due to misuse or customer installation.

Trailer Lamps

WARNING



Never connect any trailer lamp wiring to the vehicle's tail lamp wiring; this may damage the electrical system resulting in fire. Contact your authorized dealer as soon as possible for assistance in proper trailer tow wiring installation. Additional electrical equipment may be required.

Trailer lamps are required on most towed vehicles. Make sure all running lights, brake lights, turn signals and hazard lights are working.

Using a Step Bumper (if Equipped)

The rear bumper is equipped with an integral hitch and only requires a ball with a one-inch (25.4 millimeter) shank diameter. The bumper has a 5000-pound (2268 kilogram) trailer weight and a 500-pound (227 kilogram) tongue weight capacity.

If it is necessary to relocate the hitch ball position, you must install a frame-mounted trailer hitch.

Before Towing a Trailer

Practice turning, stopping and backing up to get the feel of your vehicle-trailer combination before starting on a trip. When turning, make wider turns so the trailer wheels clear curbs and other obstacles.

When Towing a Trailer

- Do not drive faster than 70 mph (113 km/h) during the first 500 miles (800 kilometers).
- Do not make full-throttle starts.
- Check your hitch, electrical connections and trailer wheel lug nuts thoroughly after you have traveled 50 miles (80 kilometers).
- When stopped in congested or heavy traffic during hot weather, place the gearshift in position **P** to aid engine and transmission cooling and to help A/C performance.
- Turn off the speed control with heavy loads or in hilly terrain. The speed control may turn off automatically when you are towing on long, steep grades.

Towing

- Shift to a lower gear when driving down a long or steep hill. Do not apply the brakes continuously, as they may overheat and become less effective.
- If your transmission is equipped with a Grade Assist or Tow/Haul feature, use this feature when towing. This provides engine braking and helps eliminate excessive transmission shifting for optimum fuel economy and transmission cooling.
- If your vehicle is equipped with AdvanceTrac with RSC, this system may turn on during typical cornering maneuvers with a heavily loaded trailer. This is normal. Turning the corner at a slower speed while towing may reduce this tendency.
- If you are towing a trailer frequently in hot weather, hilly conditions, at the gross combined weight rating (or any combination of these factors), consider refilling your rear axle with synthetic gear lubricant (if the axle is not already filled with it). See **Capacities and Specifications** (page 361).
- Allow more distance for stopping with a trailer attached. Anticipate stops and brake gradually.
- Avoid parking on a grade. However, if you must park on a grade:
 1. Turn the steering wheel to point your vehicle tires away from traffic flow.
 2. Set your vehicle parking brake.
 3. Place the automatic transmission in position **P**.
 4. Place wheel chocks in front and back of the trailer wheels. (Chocks not included with vehicle.)

Your vehicle may be equipped with a temporary or conventional spare tire. A "temporary" spare tire is different in size (diameter or width), tread-type (All-Season or All Terrain) or is from a different manufacturer than the road tires on your vehicle. Consult information on the tire label or Safety Compliance label for limitations when using.

Launching or Retrieving a Boat or Personal Watercraft (PWC)

Note: *Disconnect the wiring to the trailer before backing the trailer into the water.*

Note: *Reconnect the wiring to the trailer after removing the trailer from the water.*

When backing down a ramp during boat launching or retrieval:

- Do not allow the static water level to rise above the bottom edge of the rear bumper.
- Do not allow waves to break higher than 6 inches (15 centimeters) above the bottom edge of the rear bumper.

Exceeding these limits may allow water to enter vehicle components:

- Causing internal damage to the components.
- Affecting driveability, emissions, and reliability.

Replace the rear axle lubricant anytime the rear axle has been submerged in water. Water may have contaminated the rear axle lubricant, which is not normally checked or changed unless a leak is suspected or other axle repair is required.

Towing

TOWING POINTS

WARNINGS



Using recovery hooks is dangerous and should only be done by a person familiar with proper vehicle recovery safety practices. Improper use of recovery hooks may cause hook failure or separation from the vehicle and could result in serious injury or death.



Always slowly remove the slack from the recovery strap prior to pulling. Failure to do so can introduce significantly higher loads which can cause the recovery hooks to break off, or the recovery strap to fail which can cause serious injury or death.



Never link two straps together with a clevis pin. These heavy metal objects could become projectiles if the strap breaks and can cause serious injury or death.

Your vehicle comes equipped with frame-mounted front recovery hooks. These hooks should never have a load applied to them greater than the gross vehicle weight rating of your vehicle.

Before using recovery hooks:

- Make sure all attaching points are secure and capable of withstanding the applied load.
- Never use chains, cables or tow straps with metal hook ends.
- Only use recovery straps that have a minimum breaking strength two to three times the gross vehicle weight of the stuck vehicle.
- Make sure the recovery strap is in good condition and free of visible cuts, tears or damage.
- Use a damper device such as a tarp, heavy blanket or piece of carpet draped over the recovery strap to help absorb the energy in the event the strap breaks.
- Make sure the stuck vehicle is not loaded heavier than its gross vehicle weight rating specified on the certification label.
- Always align the tow vehicle and stuck vehicle in a straight line (within 10 degrees).
- Keep bystanders to the **sides** of the vehicle, at a distance of at least twice the length of the recovery strap. This helps avoid injury from the hazard of a recovery hook or strap breaking, or a vehicle lurching into their path.

Towing

TRANSPORTING THE VEHICLE

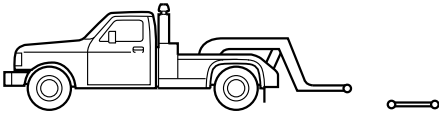

It is acceptable to have your two-wheel drive vehicle towed with the front wheels on the ground (without dollies) and the rear wheels off the ground.

We recommend towing a four-wheel drive vehicle with all wheels off the ground, such as using a wheel lift and dollies or flatbed equipment.

TOWING THE VEHICLE ON FOUR WHEELS

WARNING



If your vehicle has a steering wheel lock make sure the ignition is in the accessory or on position when being towed.

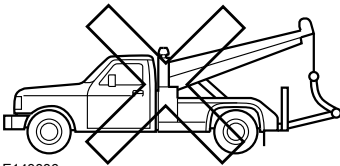
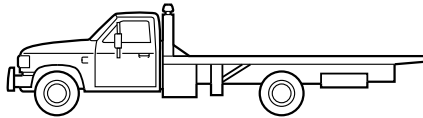

E143886

If you need to have your vehicle towed, contact a professional towing service or, if you are a member of a roadside assistance program, your roadside assistance service provider.

We recommend the use of a wheel lift and dollies or flatbed equipment to tow your vehicle. Do not tow with a slingbelt. Ford Motor Company has not approved a slingbelt towing procedure. Vehicle damage may occur if towed incorrectly, or by any other means.

Ford Motor Company produces a towing manual for all authorized tow truck operators. Have your tow truck operator refer to this manual for proper hook-up and towing procedures for your vehicle.

Emergency Towing

If your vehicle becomes inoperable (without access to wheel dollies, car-hauling trailer, or flatbed transport vehicle), it can be flat-towed (all wheels on the ground, regardless of the powertrain and transmission configuration) under the following conditions:

- Your vehicle is facing forward for towing in a forward direction.
- Place the transmission in position **N**. If you cannot move the transmission into **N**, you may need to override it. See **Transmission** (page 174).
- Maximum speed is 35 mph (56 km/h).
- Maximum distance is 50 mi (80 km).

Recreational Towing

Note: Put your climate control system in recirculated air mode to prevent exhaust fumes from entering your vehicle. See **Climate Control** (page 131).

Towing

Follow these guidelines if you have a need for recreational towing, such as towing your vehicle behind a motorhome. We designed these guidelines to prevent damage to your transmission.

Two-wheel Drive Vehicles

You cannot tow a two-wheel drive vehicle with any wheels on the ground as vehicle or transmission damage may occur. You must tow your vehicle with all four wheels off the ground, such as when using a car-hauling trailer.

Four-wheel Drive Vehicles

You can only tow a four-wheel drive vehicle with all wheels on the ground by placing the transfer case in its neutral position and engaging the four-wheel-down towing feature. Perform the steps outlined in the following section after positioning your vehicle behind the tow vehicle and properly securing them together.

Note: Make sure you properly secure your vehicle to the tow vehicle.

Four-wheel-down Towing

1. Put the ignition in the on position, but do not start the engine. If your vehicle has an ignition key, turn the key to on. If your vehicle has intelligent access, press the engine **START/STOP** button once without pressing the brake pedal.
2. Press and hold the brake pedal.
3. Rotate the four-wheel drive switch to **2H**.
4. Shift the transmission to position **N**.
5. Rotate the four-wheel drive switch from **2H** to **4L** and back to **2H** five times within seven seconds.

Note: If completed successfully, the information display shows **NEUTRAL TOW LEAVE IN N** or **NEUTRAL TOW ENABLED LEAVE TRANSMISSION IN NEUTRAL**. This indicates that your vehicle is safe to tow with all wheels on the ground.

Note: If you do not see the message in the display, you must perform the procedure again from the beginning.

Note: You may hear an audible noise as the transfer case shifts into its neutral position. This is normal.

6. Leave the transmission in position **N** and turn the ignition as far as it will go toward the off position (it will not turn fully off when the transmission is in position **N**). If your vehicle has an ignition key, you must leave the key in the ignition while towing. To lock and unlock your vehicle, use the keyless entry keypad or extra set of keys. If your vehicle has intelligent access, press the engine **START/STOP** button once without pressing the brake pedal. You do not need to leave your keys in the vehicle. You can lock and unlock your vehicle as you normally do.
7. Release the brake pedal.

WARNINGS



Do not disconnect the battery during recreational towing. Doing so will prevent the transfer case from shifting properly and may cause the vehicle to roll even if the transmission is in P (Park).



Shifting the transfer case to its neutral position for recreational towing may cause the vehicle to be able to roll even if the transmission is in P (Park). The driver or others could be injured. Make sure the foot brake is depressed and the vehicle is in a secure and safe position while the transfer case is being shifted to its neutral position.

Towing

WARNINGS



Failing to put the transfer case in its neutral position will damage vehicle components.

Note: You can check four-wheel-down towing status at any time by opening the driver's door or turning the ignition to the accessory or on position and verifying the **NEUTRAL TOW ENABLED** message displays in the cluster.

To exit four-wheel-down towing and return the transfer case to its **2H** position:

1. With your vehicle still properly secured to the tow vehicle, put the ignition in the on position, but do not start the engine. If your vehicle has an ignition key, turn the key to on. If your vehicle has intelligent access, press the engine **START/STOP** button once without pressing the brake pedal.
2. Press and hold the brake pedal.
3. Shift the transmission out of **N** and into any gear.
4. Release the brake pedal.

Note: If completed successfully, the instrument cluster displays **4X2**, and **NEUTRAL TOW DISABLED**.

Note: If the indicator light and message do not display, you must perform the procedure again from the beginning.

Note: You may hear an audible noise as the transfer case shifts out of its neutral position. This is normal.

Note: If **SHIFT DELAY PULL FORWARD** displays in the instrument cluster, transfer case gear tooth blockage is present. See the instructions after this section.

5. Apply the parking brake, and then disconnect the vehicle from the tow vehicle.

6. Release the parking brake, start the engine, and shift the transmission to position **D** to make sure the transfer case is out of position **N**.
7. If the transfer case does not successfully shift out of position **N**, set the parking brake until you can have your vehicle serviced.

Resolving the **SHIFT DELAY PULL FORWARD** Message

If the instrument cluster displays **SHIFT DELAY PULL FORWARD** perform the following:

1. Press and hold the brake pedal.
2. Put the transmission into position **N**, and then start the engine.
3. With the engine running, shift the transmission to position **D** and let the vehicle roll forward, up to 3 feet (1 meter). You may hear an audible noise as the transfer case shifts out of its neutral position. This is normal.
4. Make sure the instrument cluster displays **NEUTRAL TOW DISABLED**.

Driving Hints

BREAKING-IN

You need to break in new tires for approximately 300 miles (480 kilometers). During this time, your vehicle may exhibit some unusual driving characteristics.

Avoid driving too fast during the first 1000 miles (1600 kilometers). Vary your speed frequently and change up through the gears early. Do not labor the engine.

Do not tow during the first 1000 miles (1600 kilometers).

ECONOMICAL DRIVING

Your fuel economy is affected by several things, such as how you drive, the conditions you drive under, and how you maintain your vehicle.

You may improve your fuel economy by keeping these things in mind:

- Accelerate and slow down in a smooth, moderate fashion.
- Drive at steady speeds without stopping.
- Anticipate stops; slowing down may eliminate the need to stop.
- Combine errands and minimize stop-and-go driving.
- Close the windows for high-speed driving.
- Drive at reasonable speeds (traveling at 55 mph [88 km/h] uses 15% less fuel than traveling at 65 mph [105 km/h]).
- Keep the tires properly inflated and use only the recommended size.
- Use the recommended engine oil.
- Perform all regularly scheduled maintenance.

Avoid these actions; they reduce your fuel economy:

- Sudden accelerations or hard accelerations.
- Revving the engine before turning it off.
- Idle for periods longer than one minute.
- Warm up your vehicle on cold mornings.
- Use the air conditioner or front defroster.
- Use the speed control in hilly terrain.
- Rest your foot on the brake pedal while driving.
- Drive a heavily loaded vehicle or tow a trailer.
- Carry unnecessary weight (approximately 1 mpg [0.4 km/L] is lost for every 400 lb [180 kilogram] of weight carried).
- Driving with the wheels out of alignment.

Conditions

- Heavily loading a vehicle or towing a trailer may reduce fuel economy at any speed.
- Adding certain accessories to your vehicle (for example bug deflectors, rollbars, light bars, running boards, ski racks or luggage racks) may reduce fuel economy.
- To maximize the fuel economy, drive with the tonneau cover installed (if equipped).
- Using fuel blended with alcohol may lower fuel economy.
- Fuel economy may decrease with lower temperatures during the first 8–10 miles (12–16 kilometers) of driving.
- Driving on flat terrain offers improved fuel economy as compared to driving on hilly terrain.

Driving Hints

- Transmissions give their best fuel economy when operated in the top cruise gear and with steady pressure on the gas pedal.
- Four-wheel-drive operation (if equipped) is less fuel efficient than two-wheel-drive operation.
- Close the windows for high-speed driving.

DRIVING THROUGH WATER

WARNING



Do not drive through flowing or deep water as you may lose control of your vehicle.

Note: *Driving through standing water can cause vehicle damage.*

Note: *Engine damage can occur if water enters the air filter.*

Before driving through standing water, check the depth. Never drive through water that is higher than the bottom of the wheel hubs.

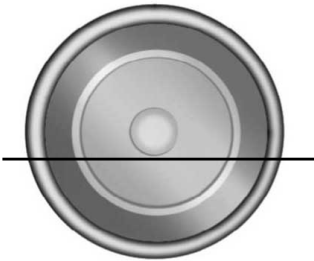

E176913

When driving through standing water, drive very slowly and do not stop your vehicle. Your brake performance and traction may be limited. After driving through water and as soon as it is safe to do so:

- Lightly press the brake pedal to dry the brakes and to check that they work.
- Check that the horn works.
- Check that the exterior lights work.
- Turn the steering wheel to check that the steering power assist works.

FLOOR MATS

WARNINGS



Always use floor mats that are designed to fit the foot well of your vehicle. Only use floor mats that leave the pedal area unobstructed. Only use floor mats that are firmly secured to retention posts so that they cannot slip out of position and interfere with the pedals or impair safe operation of your vehicle in other ways.



Pedals that cannot move freely can cause loss of vehicle control and increase the risk of serious personal injury.



Always make sure that the floor mats are properly attached to the retention posts in the carpet that are supplied with your vehicle. Floor mats must be properly secured to both retention posts to make sure mats do not shift out of position.



Never place floor mats or any other covering in the vehicle foot well that cannot be properly secured to prevent them from moving and interfering with the pedals or the ability to control the vehicle.



Never place floor mats or any other covering on top of already installed floor mats. Floor mats should always rest on top of vehicle carpeting surface and not another floor mat or other covering. Additional floor mats or any other covering will reduce the pedal clearance and potentially interfere with pedal operation.

Driving Hints

WARNINGS



Check attachment of floor mats on a regular basis. Always properly reinstall and secure floor mats that have been removed for cleaning or replacement.



Always make sure that objects cannot fall into the driver foot well while the vehicle is moving. Objects that are loose can become trapped under the pedals causing a loss of vehicle control.



Failure to properly follow floor mat installation or attachment instructions can potentially cause interference with pedal operation causing a loss of vehicle control.



E142666

To install floor mats, position the floor mat so that the eyelet is over the retention post and press down to lock in.

To remove the floor mat, reverse the installation procedure.

SNOWPLOWING

We recommend the four-wheel drive F-150 in XL, XLT or Lariat trim levels with the 5.0L engine and snowplow option for residential snowplowing only. We do not recommend the F-150 with the automatic four-wheel drive system for snowplowing.

Do not use F-150 vehicles equipped with the 2.7L or 3.5L engines for snowplowing.

Installing the Snowplow

Weight limits and guidelines for selecting and installing the snowplow are in the Ford Truck Body Builders Layout Book, snowplow section, found at www.fleet.ford.com/truckbbas.

A typical installation affects the following:

- Certification to government safety laws such as occupant protection and airbag deployment, braking, and lighting. Look for an Alterer's Label on your vehicle from the snowplow installer certifying that the installation meets all applicable Federal Motor Vehicle Safety Standards (FMVSS).
- The Front Gross Axle Weight Rating (GAWR) is on the upper left side of the vehicle's Safety Compliance Certification Label. This is the total weight that front axle supports, which includes the vehicle weight plus any auxiliary equipment such as snowplow frame-mounted hardware that can be added to the vehicle and satisfy Ford compliance certification to FMVSS. Do not exceed FGAWR or Gross Vehicle Weight Rating (GVWR).
- Rear ballast weight behind the rear axle may be required to prevent exceeding the FGAWR, and provide front-to-rear weight balance for proper braking and steering.
- Front wheel toe may require re-adjustment to prevent premature uneven tire wear. Specifications are in the Ford Workshop Manual.
- Headlight aim may require adjustment.

Driving Hints

- The tire air pressures recommended for general driving are on the vehicle's Safety Certification Label. The maximum cold inflation pressure for the tire and associated load rating are on the tire sidewall. Tire air pressure may require re-adjustment within these pressure limits to accommodate the additional weight of the snowplow installation.
- Federal and some local regulations require additional exterior lamps for snowplow-equipped vehicles. Contact an authorized dealer for additional information.

Snowplow Mode (If Equipped)

Press the snowplow button on the instrument panel to switch on snowplow mode. The button illuminates when in snowplow mode. A message appears in the information display indicating that features are turned off when in snowplow mode.

The following features are disabled when in snowplow mode:

- 110V inverter.
- Fog lamps.
- Heated steering wheel.
- Heated front and rear seats.
- Massaging seats.

The body module also activates the snowplow relay that provides power to aftermarket snowplow controls.

Switch off snowplow mode by pressing the snowplow button or switching off the ignition. The snowplow button is no longer illuminated and features are turned on.

Note: *The electrical system is designed to support the addition of a residential snowplow (up to 60 Amps continuous) and snowplow lights (up to 20 Amps continuous) using snowplow mode. The system is not designed to support snowplow usage with additional electrical aftermarket accessories.*

Operating the Vehicle with the Snowplow Attached

Note: *Drive the vehicle at least 500 miles (800 kilometers) before using your vehicle for snow removal.*

We recommend vehicle speed does not exceed 45 mph (72 km/h) when snowplowing.

The attached snowplow blade restricts airflow to the radiator, and may cause the engine to run at a higher temperature. Attention to engine temperature is especially important when outside temperatures are above freezing. Angle the blade to maximize airflow to the radiator and monitor engine temperature to determine whether a left or right angle provides the best performance.

Follow the severe duty schedule in your Scheduled Maintenance information for engine oil and transmission fluid change intervals.

Snowplowing with your Airbag Equipped Vehicle

WARNINGS



Do not attempt to service, repair, or modify the airbag supplemental restraint system (SRS) or its fuses. Contact a Ford or Lincoln dealer.

Driving Hints

WARNINGS



Additional equipment such as snowplow equipment may affect the performance of the airbag sensors increasing the risk of injury. Please refer to the Body Builders Layout Book for instructions about the appropriate installation of additional equipment.



All occupants of the vehicle, including the driver, should always properly wear their safety belts, even when provided with an airbag supplemental restraint system (SRS).

Your vehicle is equipped with a driver and passenger airbag supplemental restraint system. The supplemental restraint system activates in certain frontal and offset frontal collisions when the vehicle sustains sufficient longitudinal deceleration.

Careless or high speed driving while snowplowing, which results in significant vehicle decelerations, can deploy the airbag. Such driving also increases the risk of accidents.

Never remove or defeat the tripping mechanisms designed into the snow removal equipment by its manufacturer. Doing so may cause damage to the vehicle and the snow removal equipment as well as possible airbag deployment.

Engine Temperature while Plowing

Your engine may run at a higher temperature than normal because the attached snowplow blade restricts airflow to the radiator:

- If you are driving more than 15 mi (24 km) at temperatures above freezing, angle the plow blade either full left or full right to provide maximum airflow to the radiator.
- If you are driving less than 15 mi (24 km) at speeds up to 45 mph (72 km/h) in cold weather, you do not need to worry about blade position to provide maximum airflow.

Transmission Operation while Plowing

WARNING



Do not spin the wheels at over 35 mph (55 km/h). The tires may fail and injure a passenger or bystander.

- Shift transfer case to **4L** (4WD Low) when plowing in small areas at speeds below 5.0 mph (8 km/h).
- Shift transfer case to **4H** (4WD High) when plowing larger areas or light snow at higher speeds. Do not exceed 15 mph (24 km/h).
- Do not shift the transmission from a forward gear to **R** (Reverse) until the engine is at idle and the wheels have stopped.

Outside Air Temperature While Plowing

While plowing with your vehicle, the plow blade can block the sensor airflow and cause the outside air temperature reading to be inaccurate.

A Ford wiring kit is available to relocate the Outside Air Temperature sensor to the plow blade frame to provide more accurate outside air temperature readings. Contact an authorized dealer for more information.

Roadside Emergencies

ROADSIDE ASSISTANCE

Vehicles Sold in the United States: Getting Roadside Assistance

To fully assist you should you have a vehicle concern, Ford Motor Company offers a complimentary roadside assistance program. This program is separate from the New Vehicle Limited Warranty. The service is available:

- 24 hours a day, seven days a week.
- For the coverage period listed on the Roadside Assistance Card included in your Owner's Manual portfolio.

Roadside Assistance covers:

- A flat tire change with a good spare, if provided with the vehicle (except vehicles supplied with a tire inflation kit).
- Battery jump start.
- Lock-out assistance (key replacement cost is the customer's responsibility).
- Fuel delivery — independent service contractors, if not prohibited by state, local or municipal law, shall deliver up to 2 gal (7.6 L) of gasoline or 5 gal (18.9 L) of diesel fuel to a disabled vehicle. Roadside Assistance limits fuel delivery service to two no-charge occurrences within a 12-month period.
- Winch out — available within 100 ft (30.5 m) of a paved or county maintained road, no recoveries.
- Towing — independent service contractors, if not prohibited by state, local or municipal law, shall tow Ford eligible vehicles to an authorized dealer within 35 mi (56 km) of the disablement location or to the nearest

authorized dealer. If a member requests a tow to an authorized dealer that is more than 35 mi (56 km) from the disablement location, the member shall be responsible for any mileage costs in excess of 35 mi (56 km).

Roadside Assistance includes up to \$200 for a towed trailer if the disabled eligible vehicle requires service at the nearest authorized dealer. If the towing vehicle is operational but the trailer is not, then the trailer does not qualify for any roadside services.

Vehicles Sold in the United States: Using Roadside Assistance

Complete the roadside assistance identification card and place it in your wallet for quick reference. This card is in the owner's information portfolio in the glove compartment.

United States Ford vehicle customers who require Roadside Assistance, call 1-800-241-3673.

If you need to arrange roadside assistance for yourself, Ford Motor Company reimburses a reasonable amount for towing to the nearest dealership within 35 mi (56 km). To obtain reimbursement information, United States Ford vehicle customers call 1-800-241-3673. Customers need to submit their original receipts.

Vehicles Sold in Canada: Getting Roadside Assistance

Canadian customers who require roadside assistance, call 1-800-665-2006.

Vehicles Sold in Canada: Using Roadside Assistance

For your convenience, you may complete the roadside assistance identification card found in the centerfold of your warranty guide and retain for future reference.

Roadside Emergencies

Canadian roadside coverage and benefits may differ from the U.S. coverage. If you require more information, please refer to the coverage section of your warranty guide, call us in Canada at 1-800-665-2006, or visit our website at www.ford.ca.

Sykes Assistance Services Corporation administers the Roadside Assistance program. You must receive covered services in Canada or the continental United States. Coverage extends to vehicles that use public, non-seasonal, annually traveled roadways. Roadside Assistance coverage does not extend to vehicles involved in cross-country driving, logging, autocross and any other form of off-road use. Well maintained roads and surfaces help ensure safe travel for the supplier, and allow their representatives to perform service as per the standard operating procedures.

In Remote Locations

If our supplier cannot take your vehicle by road to the nearest authorized dealership, transportation by rail or water may be necessary. The program covers a tow to the dock or rail terminal and also to the dealership at the end of the trip.

For rail or water transportation, however, contact your authorized dealer to confirm if you are eligible for additional coverage before you authorize or pay for the service.

Call Ford Roadside Assistance at 1-800-665-2006 for additional information.

HAZARD WARNING FLASHERS

Note: *The hazard warning flashers will operate when the ignition is in any position or if the key is not in the ignition. If used when the engine is not running, the battery will lose charge. As a result, there may be insufficient power to restart your engine.*



The hazard flasher control is located on the instrument panel by the radio. Use it when your vehicle is disabled and is creating a safety hazard for other motorists.

- Press the flasher control and all front and rear direction indicators flash.
- Press the flasher control again to turn them off.

FUEL SHUTOFF

WARNING



Failure to inspect and, if necessary, repair fuel leaks after a collision may increase the risk of fire and serious injury. Ford Motor Company recommends that the fuel system be inspected by an authorized dealer after any collision.

In the event of a moderate to severe collision, this vehicle is equipped with a fuel pump shut-off feature that stops the flow of fuel to the engine. Not every impact will cause a shut-off.

Should your vehicle shut off after a collision, you may restart your vehicle. For vehicles equipped with a key system:

1. Switch off the ignition.
2. Switch on the ignition.
3. Repeat Steps 1 and 2 to re-enable the fuel pump.

Roadside Emergencies

For vehicles equipped with a push button start system:

1. Press the **START/STOP** button to switch off the ignition.
2. Press the brake pedal and press the **START/STOP** button to switch on the ignition.
3. Remove your foot from the brake pedal and press the **START/STOP** button to switch off the ignition.
4. You can either attempt to start the engine by pressing the brake pedal and the **START/STOP** button, or switch on the ignition only by pressing the **START/STOP** button without pressing the brake pedal. Both ways re-enable the fuel system.

Note: *When you try to restart your vehicle after a fuel shutoff, the vehicle makes sure that various systems are safe to restart. Once your vehicle determines that the systems are safe, then the vehicle will allow you to restart.*

Note: *In the event that your vehicle does not restart after your third attempt, contact an authorized dealer.*

JUMP STARTING THE VEHICLE

WARNINGS



Batteries normally produce explosive gases which can cause personal injury. Therefore, do not allow flames, sparks or lighted substances to come near the battery. When working near the battery, always shield your face and protect your eyes. Always provide correct ventilation.

WARNINGS



Keep batteries out of reach of children. Batteries contain sulfuric acid. Avoid contact with skin, eyes or clothing. Shield your eyes when working near the battery to protect against possible splashing of acid solution. In case of acid contact with skin or eyes, flush immediately with water for a minimum of 15 minutes and get prompt medical attention. If acid is swallowed, call a physician immediately.



Use only adequately sized cables with insulated clamps.

Preparing Your Vehicle

Do not attempt to push-start your automatic transmission vehicle.

Note: *Attempting to push-start a vehicle with an automatic transmission may cause transmission damage.*

Note: *Use only a 12-volt supply to start your vehicle.*

Note: *Do not disconnect the battery of the disabled vehicle as this could damage the vehicle electrical system.*

Park the booster vehicle close to the hood of the disabled vehicle, making sure the two vehicles do not touch.

Connecting the Jumper Cables

WARNINGS



Do not attach the cables to fuel lines, engine rocker covers, the intake manifold or electrical components as grounding points. Stay clear of moving parts. To avoid reverse polarity connections, make sure that you correctly identify the positive (+) and negative (-) terminals on both the disabled and booster vehicles before connecting the cables.

Roadside Emergencies

WARNINGS



Do not attach the end of the positive cable to the studs or L-shaped eyelet located above the positive (+) terminal of your vehicle's battery. High current may flow through and cause damage to the fuses.



Do not connect the end of the second cable to the negative (-) terminal of the battery to be jumped. A spark may cause an explosion of the gases that surround the battery.

Note: In the illustration, the bottom vehicle represents the booster vehicle.

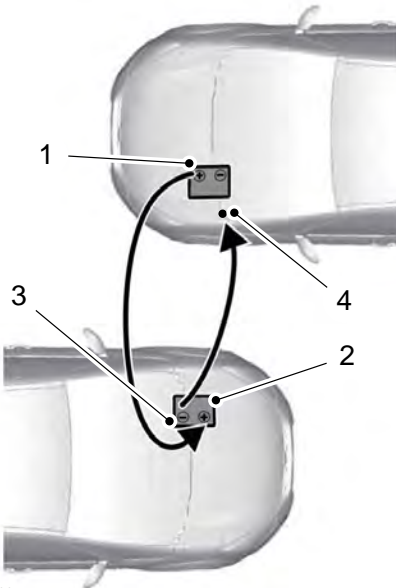

E142664

1. Connect the positive (+) jumper cable to the positive (+) terminal of the discharged battery.

2. Connect the other end of the positive (+) cable to the positive (+) terminal of the booster vehicle battery.
3. Connect the negative (-) cable to the negative (-) terminal of the booster vehicle battery.
4. Make the final connection of the negative (-) cable to an exposed metal part of the stalled vehicle's engine, away from the battery and the fuel injection system, or connect the negative (-) cable to a ground connection point if available.

Jump Starting

1. Start the engine of the booster vehicle and rev the engine moderately, or press the accelerator gently to keep your engine speed between 2000 and 3000 RPM, as shown in your tachometer.
2. Start the engine of the disabled vehicle.
3. Once the disabled vehicle has been started, run both vehicle engines for an additional three minutes before disconnecting the jumper cables.

Removing the Jumper Cables

Remove the jumper cables in the reverse order that they were connected.

Roadside Emergencies

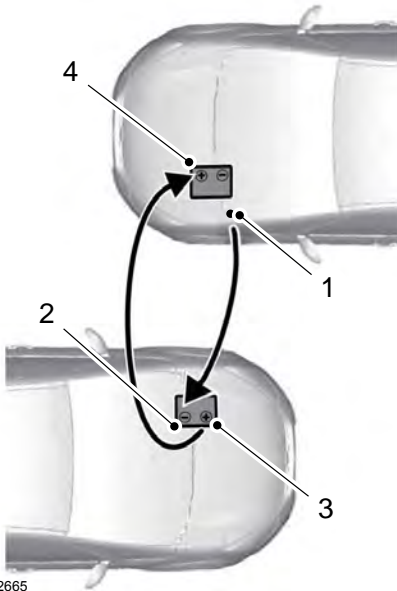

E142665

1. Remove the negative (-) jumper cable from the disabled vehicle.
2. Remove the jumper cable on the negative (-) terminal of the booster vehicle battery.
3. Remove the jumper cable from the positive (+) terminal of the booster vehicle battery.
4. Remove the jumper cable from the positive (+) terminal of the disabled vehicle battery.
5. Allow the engine to idle for at least one minute.

POST-CRASH ALERT SYSTEM

The system flashes the direction indicators and sounds the horn (intermittently) in the event of a serious impact that deploys an airbag (front, side, side curtain or Safety Canopy) or the safety belt pretensioners.

The horn and indicators will turn off when:

- You press the hazard control button.
- You press the panic button on the remote entry transmitter (if equipped).
- Your vehicle runs out of power.

Customer Assistance

GETTING THE SERVICES YOU NEED

Warranty repairs to your vehicle must be performed by an authorized dealer. While any authorized dealer handling your vehicle line will provide warranty service, we recommend you return to your selling authorized dealer who wants to ensure your continued satisfaction.

Please note that certain warranty repairs require special training and equipment, so not all authorized dealers are authorized to perform all warranty repairs. This means that, depending on the warranty repair needed, you may have to take your vehicle to another authorized dealer.

A reasonable time must be allowed to perform a repair after taking your vehicle to the authorized dealer. Repairs will be made using Ford or Motorcraft® parts, or remanufactured or other parts that are authorized by Ford.

Away From Home

If you are away from home when your vehicle needs service, contact the Ford Customer Relationship Center or use the online resources listed below to find the nearest authorized dealer.

In the United States:

Mailing address

Ford Motor Company
Customer Relationship Center
P.O. Box 6248
Dearborn, MI 48126

Telephone

1-800-392-3673 (FORD)
(TDD for the hearing impaired:
1-800-232-5952)

Additional information and resources are available online:

Website
www.owner.ford.com

These are some of the items that can be found online:

- U.S. dealer locator by Dealer Name, City/State or Zip Code.
- Owner Manuals.
- Maintenance Schedules.
- Recalls.
- Ford Extended Service Plans.
- Ford Genuine Accessories.
- Service specials and promotions.

In Canada:

Mailing address

Customer Relationship Centre
Ford Motor Company of Canada, Limited
P.O. Box 2000
Oakville, Ontario L6K 0C8

Telephone

1-800-565-3673 (FORD)

Website
www.ford.ca

Twitter

@FordServiceCA (English Canada)
@FordServiceQC (Quebec)

Additional Assistance

If you have questions or concerns, or are unsatisfied with the service you are receiving, follow these steps:

1. Contact your Sales Representative or Service Advisor at your selling or servicing authorized dealer.

Customer Assistance

2. If your inquiry or concern remains unresolved, contact the Sales Manager, Service Manager or Customer Relations Manager.
3. If you require assistance or clarification on Ford Motor Company policies, please contact the Ford Customer Relationship Center.

In order to help us serve you better, please have the following information available when contacting a Customer Relationship Center:

- Vehicle Identification Number.
- Your telephone number (home and business).
- The name of the authorized dealer and city where located.
- The vehicle's current odometer reading.

In some states within the United States, you must directly notify Ford in writing before pursuing remedies under your state's warranty laws, and Ford is also allowed a final repair attempt.

Additionally, in some states within the United States, a consumer has the option of submitting a warranty dispute to the BBB Auto Line before taking action under the Magnuson-Moss Warranty Act, or to the extent allowed by state law, before pursuing replacement or repurchase remedies provided by certain state laws. This dispute handling procedure is not required prior to enforcing state created rights or other rights which are independent of the Magnuson-Moss Warranty Act or state replacement or repurchase laws.

IN CALIFORNIA (U.S. ONLY)

California Civil Code Section 1793.2(d) requires that, if a manufacturer or its representative is unable to repair a motor vehicle to conform to the vehicle's applicable express warranty after a reasonable number of attempts, the manufacturer shall be required to either replace the vehicle with one substantially identical or repurchase the vehicle and reimburse the buyer in an amount equal to the actual price paid or payable by the consumer (less a reasonable allowance for consumer use). The consumer has the right to choose whether to receive a refund or replacement vehicle.

California Civil Code Section 1793.22(b) presumes that the manufacturer has had a reasonable number of attempts to conform the vehicle to its applicable express warranties if, within the first 18 months of ownership of a new vehicle or the first 18000 miles (29 000 km), whichever occurs first:

1. Two or more repair attempts are made on the same non-conformity likely to cause death or serious bodily injury OR
2. Four or more repair attempts are made on the same nonconformity (a defect or condition that substantially impairs the use, value or safety of the vehicle) OR
3. The vehicle is out of service for repair of nonconformities for a total of more than 30 calendar days (not necessarily all at one time).

In the case of 1 or 2 above, the consumer must also notify the manufacturer of the need for the repair of the nonconformity at the following address:

Ford Motor Company
16800 Executive Plaza Drive
Mail Drop 3NE-B
Dearborn, MI 48126

Customer Assistance

You are required to submit your warranty dispute to BBB AUTO LINE before asserting in court any rights or remedies conferred by California Civil Code Section 1793.22(b). You are also required to use BBB AUTO LINE before exercising rights or seeking remedies created by the Federal Magnuson-Moss Warranty Act, 15 U.S.C. sec. 2301 et seq. If you choose to seek redress by pursuing rights and remedies not created by California Civil Code Section 1793.22(b) or the Magnuson-Moss Warranty Act, resort to BBB AUTO LINE is not required by those statutes.

THE BETTER BUSINESS BUREAU (BBB) AUTO LINE PROGRAM (U.S. ONLY)

Your satisfaction is important to Ford Motor Company and to your dealer. If a warranty concern has not been resolved using the three-step procedure outlined earlier in this chapter in the Getting the Services you need section, you may be eligible to participate in the BBB AUTO LINE program.

The BBB AUTO LINE program consists of two parts – mediation and arbitration. During mediation, a representative of the BBB will contact both you and Ford Motor Company to explore options for settlement of the claim. If an agreement is not reached during mediation or you do not want to participate in mediation, and if your claim is eligible, you may participate in the arbitration process. An arbitration hearing will be scheduled so that you can present your case in an informal setting before an impartial person. The arbitrator will consider the testimony provided and make a decision after the hearing.

Disputes submitted to the BBB AUTO LINE program are usually decided within forty days after you file your claim with the BBB. You are not bound by the decision, and may reject the decision and proceed to court where all findings of the BBB Auto Line dispute, and decision, are admissible in the court action. Should you choose to accept the BBB AUTO LINE decision, Ford is then bound by the decision, and must comply with the decision within 30 days of receipt of your acceptance letter.

BBB AUTO LINE Application: Using the information provided below, please call or write to request a program application. You will be asked for your name and address, general information about your new vehicle, information about your warranty concerns, and any steps you have already taken to try to resolve them. A Customer Claim Form will be mailed that will need to be completed, signed and returned to the BBB along with proof of ownership. Upon receipt, the BBB will review the claim for eligibility under the Program Summary Guidelines.

You can get more information by calling BBB AUTO LINE at 1-800-955-5100, or writing to:

**BBB AUTO LINE
3033 Wilson Boulevard, Suite 600
Arlington, Virginia 22201**

BBB AUTO LINE applications can also be requested by calling the Ford Motor Company Customer Relationship Center at 1-800-392-3673.

Note: *Ford Motor Company reserves the right to change eligibility limitations, modify procedures, or to discontinue this process at any time without notice and without obligation.*

Customer Assistance

UTILIZING THE MEDIATION/ARBITRATION PROGRAM (CANADA ONLY)

For vehicles delivered to authorized Canadian dealers. In those cases where you continue to feel that the efforts by Ford of Canada and the authorized dealer to resolve a factory-related vehicle service concern have been unsatisfactory, Ford of Canada participates in an impartial third party mediation/arbitration program administered by the Canadian Motor Vehicle Arbitration Plan (CAMVAP).

The CAMVAP program is a straight forward and relatively speedy alternative to resolve a disagreement when all other efforts to produce a settlement have failed. This procedure is without cost to you and is designed to eliminate the need for lengthy and expensive legal proceedings.

In the CAMVAP program, impartial third-party arbitrators conduct hearings at mutually convenient times and places in an informal environment. These impartial arbitrators review the positions of the parties, make decisions and, when appropriate, render awards to resolve disputes. CAMVAP decisions are fast, fair, and final as the arbitrator's award is binding on both you and Ford of Canada.

CAMVAP services are available in all Canadian territories and provinces. For more information, without charge or obligation, call your CAMVAP Provincial Administrator directly at 1-800-207-0685 or visit www.camvap.ca.

GETTING ASSISTANCE OUTSIDE THE U.S. AND CANADA

Before exporting your vehicle to a foreign country, contact the appropriate foreign embassy or consulate. These officials can inform you of local vehicle registration regulations and where to find unleaded fuel.

If you cannot find unleaded fuel or can only get fuel with an anti-knock index lower than is recommended for your vehicle, contact our Customer Relationship Center.

The use of leaded fuel in your vehicle without proper conversion may damage the effectiveness of your emission control system and may cause engine knocking or serious engine damage. Ford Motor Company or Ford of Canada is not responsible for any damage caused by use of improper fuel. Using leaded fuel may also result in difficulty importing your vehicle back into the United States.

If your vehicle must be serviced while you are traveling or living in Asia-Pacific Region, Sub-Saharan Africa, U.S. Virgin Islands, Central America, the Caribbean, and Israel, contact the nearest authorized dealer. If the authorized dealer cannot help you, contact:

FORD MOTOR COMPANY
Customer Relationship Center
1555 Fairlane Drive
Fairlane Business Park #3
Allen Park, Michigan 48101
U.S.A.
Telephone: (313) 594-4857
Fax: (313) 390-0804
Email: expcac@ford.com

Customer Assistance

For customers in Guam, the Commonwealth of the Northern Mariana Islands (CNMI), America Samoa, and the U.S. Virgin Islands, please feel free to call our Toll-Free Number: (800) 841-FORD (3673).

If your vehicle must be serviced while you are traveling or living in Puerto Rico, contact the nearest authorized dealer. If the authorized dealer cannot help you, contact:

FORD MOTOR COMPANY
Customer Relationship Center
1555 Fairlane Drive
Fairlane Business Park #3
Allen Park, Michigan 48101
U.S.A.
Telephone: (800) 841-FORD (3673)
FAX: (313) 390-0804
Email: prcac@ford.com
www.ford.com.pr

If your vehicle must be serviced while you are traveling or living in the Middle East, contact the nearest authorized dealer. If the authorized dealer cannot help you, contact:

FORD MOTOR COMPANY
Customer Relationship Center
1555 Fairlane Drive
Fairlane Business Park #3
Allen Park, Michigan 48101
U.S.A.

Ford: 80004443673
Lincoln: 80004441067
If calling from the UAE: 80004441066
If calling from the Kingdom of Saudi Arabia: 8008443673
If calling from Kuwait: 22280384

FAX: +971 4 3327266
Email: menacac@ford.com
www.me.ford.com

If you buy your vehicle in North America and then relocate to any of the above locations, register your vehicle identification number (VIN) and new address with Ford Motor Company Export Operations & Global Growth Initiatives by emailing **expcac@ford.com**.

If you are in another foreign country, contact the nearest authorized dealer. In the event your inquiry is unresolved, communicate your concern with the dealership's Sales Manager, Service Manager or Customer Relations Manager. If you require additional assistance or clarification, please contact the respective Customer Relationship Center as previously listed.

**Customers in the U.S. should call
1-800-392-3673.**

ORDERING ADDITIONAL OWNER'S LITERATURE

To order the publications in this portfolio, contact Helm, Incorporated at:

HELM, INCORPORATED
47911 Halyard Drive
Plymouth, Michigan 48170
Attention: Customer Service

Or to order a free publication catalog, call toll free: 1-800-782-4356

Monday-Friday 8:00 a.m. - 6:00 p.m. EST

Helm, Incorporated can also be reached by their website:

www.helminc.com

(Items in this catalog may be purchased by credit card, check or money order.)

Customer Assistance

Obtaining a French Owner's Manual

French Owner's Manual can be obtained from your authorized dealer or by contacting Helm, Incorporated using the contact information listed previously in this section.

REPORTING SAFETY DEFECTS (U.S. ONLY)



E142557

If you believe that your vehicle has a defect which could cause a crash or could cause injury or death, you should immediately inform the National Highway Traffic Safety Administration (NHTSA) in addition to notifying Ford Motor Company.

If NHTSA receives similar complaints, it may open an investigation, and if it finds that a safety defect exists in a group of vehicles, it may order a recall and remedy campaign. However, NHTSA cannot become involved in individual problems between you, your dealer, or Ford Motor Company.

To contact NHTSA, you may call the Vehicle Safety Hotline toll-free at 1-888-327-4236 (TTY: 1-800-424-9153); go to <http://www.safercar.gov>; or write to:

Administrator
1200 New Jersey Avenue,
Southeast
Washington, D.C. 20590

You can also obtain other information about motor vehicle safety from <http://www.safercar.gov>.

REPORTING SAFETY DEFECTS (CANADA ONLY)

If you believe that your vehicle has a defect which could cause a crash or could cause injury or death, you should immediately inform Transport Canada and Ford of Canada.

Customer Assistance

Transport Canada Contact Information	
Website	www.tc.gc.ca/eng/motorvehiclesafety/safevehicles-defectinvestigations-index-76.htm (English)
Website	www.tc.gc.ca/fra/securiteautomobile/VehiculesSecuritaires-Enquetes-index-76.htm (French)
Phone	1-800-333-0510

Ford of Canada Contact Information	
Website	www.ford.ca
Phone	1-800-565-3673

Fuses

FUSE SPECIFICATION CHART

Power Distribution Box

WARNINGS



Always disconnect the battery before servicing high current fuses.



To reduce risk of electrical shock, always replace the cover to the power distribution box before reconnecting the battery or refilling fluid reservoirs.

The power distribution box is located in the engine compartment. It has high-current fuses that protect your vehicle's main electrical systems from overloads.

If you disconnect and reconnect the battery, you will need to reset some features. See **Changing the 12V Battery** (page 309).

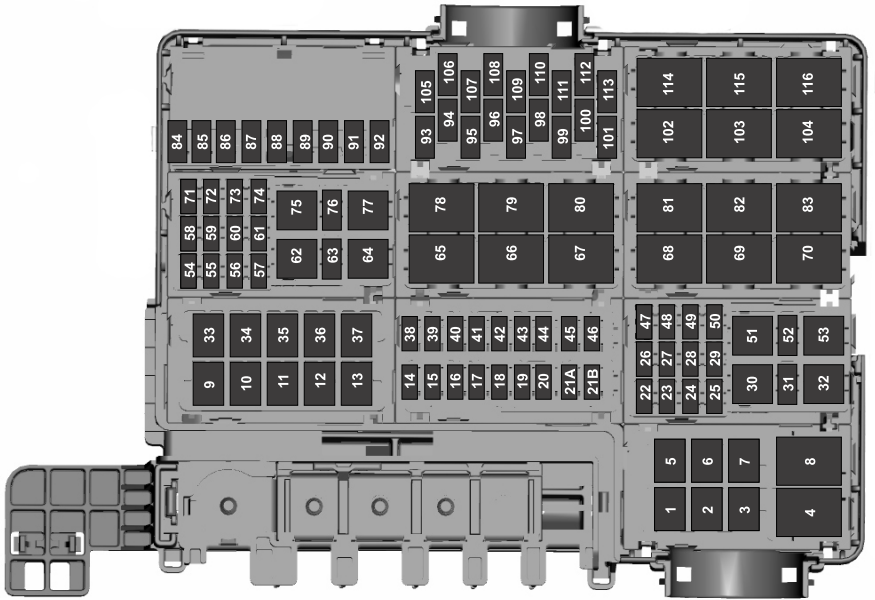

E176315

Fuse or relay number	Fuse amp rating	Protected components
1	—	Not used.
2	—	Not used.
3	—	Not used.

Fuses

Fuse or relay number	Fuse amp rating	Protected components
4	—	Telescoping side-view mirror.
5	40A*	Rear window defroster.
6	—	Not used.
7	—	Not used.
8	—	Telescoping side-view mirror.
9	—	Not used.
10	—	Not used.
11	60A*	Automatic brake system motor.
12	50A*	Body control module 1.
13	60A*	Body control module 2.
14	20A**	Amplifier.
15	25A**	4x4.
16	10A**	Spot light module.
17	15A**	Heated seat.
18	10A**	Steering-column lock.
19	10A**	Power seats.
20	15A**	Snow plow. Rear heated seats.
21A	—	Not used.
21B	—	Not used.
22	30A*	Windshield wiper motor.
23	15A*	Rain sensor.
24	25A*	Series fan feed.
25	—	Not used.
26	30A*	Driver seat motors.
27	30A*	Passenger power seat.
28	30A*	Climate controlled seat.

Fuses

Fuse or relay number	Fuse amp rating	Protected components
29	—	Not used.
30	—	Air conditioner clutch relay.
31	—	Not used.
32	—	Not used.
33	50A*	Electric fan 3.
34	25A*	Trailer tow park lamps.
35	20A*	Trailer tow stop-turn relay fuse.
36	25A*	Trailer tow lamps module.
37	50A*	Electric fan 1.
38	10A**	Alt A sensor.
39	10A**	Integrated wheel end solenoid.
40	15A**	E-locker.
41	10A**	Telescoping mirror.
42	30A**	Transmission fluid pump.
43	25A**	Horn.
44	10A**	Air conditioner clutch.
45	10A**	Powertrain control module relay coil.
46	10A**	Wiper relay coil.
47	—	Not used.
48	—	Not used.
49	30A*	Trailer brake control module.
50	30A*	Power running boards.
51	—	Fuel pump relay.
52	—	Not used.
53	—	Not used.
54	30A*	Voltage quality module. Body-control-module voltage-quality-module feed.

Fuses

Fuse or relay number	Fuse amp rating	Protected components
55	40A*	Body control module RP2 feed.
56	20A*	Fuel pump.
57	30A*	Right-hand EPB actuator.
58	30A*	Left-hand EPB actuator.
59	30A*	Starter.
60	40A*	Blower motor.
61	30A*	Brake control module. Automatic brake system valves.
62	—	Power seat relay.
63	15A**	Heated mirrors.
64	—	Not used.
65	—	Starter relay.
66	—	Powertrain control module relay.
67	—	Windshield wiper relay.
68	—	Blower motor relay.
69	—	Power sliding back window relay.
70	—	Electric fan 1 relay.
71	—	Not used.
72	25A*	4x4.
73	—	Not used.
74	30A*	PDRG motor.
75	—	Horn relay.
76	—	Not used.
77	—	Steering column lock relay.
78	—	Not used.
79	—	Trailer tow parking lamp relay.
80	—	Rear window defroster relay.

Fuses

Fuse or relay number	Fuse amp rating	Protected components
81	—	Not used.
82	—	PDRG close relay.
83	—	Not used.
84	—	Not used.
85	—	Not used.
86	—	Not used.
87	10A*	Trailer tow backup lamps.
88	—	Not used.
89	20A**	Cigar lighter power point 1.
90	20A**	Power point 2.
91	20A**	Power point 3.
92	20A**	Power point 4.
93	25A**	GTDI vehicle power 1.
	10A**	PFI vehicle power 1.
94	—	Not used.
95	25A**	Vehicle power 2.
96	—	Not used.
97	10A**	Vehicle power 3.
98	—	Not used.
99	20A**	Vehicle power 4 (PFI).
	15A**	Vehicle power 4 (GTDI).
100	—	Not used.
101	—	Not used.
102	—	Snow plow relay.
103	—	Not used.
104	—	Electric fan 3 relay.
105	10A**	Power steering.

Fuses

Fuse or relay number	Fuse amp rating	Protected components
106	—	Not used.
107	10A**	Anti-lock brakes.
108	—	Not used.
109	10A**	Powertrain control module.
110	10A**	4x4 run/start. Adaptive cruise control.
111	10A**	Transmission pump run-start.
112	—	Not used.
113	7.5A**	Blind spot information system. Rear view camera. Front view camera. Voltage quality module.
114	—	Electric fan 2 relay.
115	—	Not used.
116	—	Not used.

*Cartridge fuses

**Mini fuses

Passenger Compartment Fuse Panel

The fuse panel is in the right-hand side of the passenger footwell behind a trim panel.

To remove the trim panel, pull it toward you and swing it away from the side. To reinstall it, line up the tabs with the grooves on the panel, and then push it shut.

To remove the fuse panel cover, press in the tabs on both sides of the cover, and then pull it off.

To reinstall the fuse panel cover, place the top part of the cover on the fuse panel and push the bottom part until it latches. Gently pull on the cover to make sure it has latched properly.

Fuses

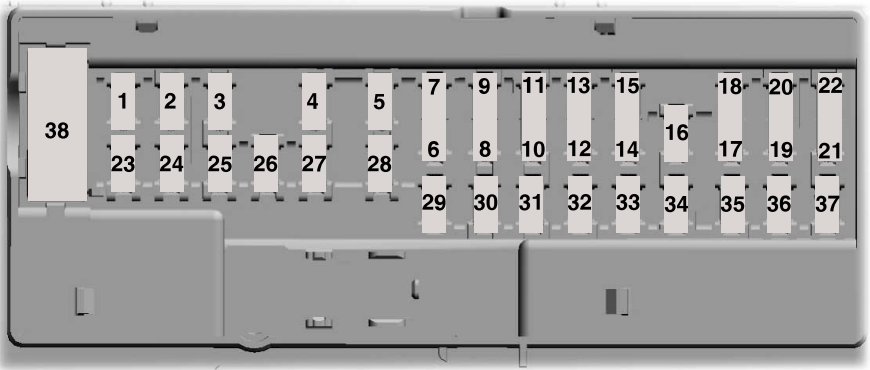

E145984

Fuse or relay number	Fuse amp rating	Protected components
1	10A	Demand lamp relay. Power seats relay. Glove box. Vanity lamps. Overhead console. Dome. Courtesy. Map lamps.
2	7.5A	Memory module logic. Memory seat switches. Lumbar motor.
3	20A	Driver door lock motor.
4	5A	Trailer brake control.
5	20A	Not used.
6	10A	Not used.
7	10A	Not used.
8	10A	Not used.
9	10A	Not used.

Fuses

Fuse or relay number	Fuse amp rating	Protected components
10	5A	Not used (spare).
11	5A	Combined sensor module.
12	7.5A	Climate head module. Smart datalink converter.
13	7.5A	Cluster. SCCM.
14	10A	Brake.
15	10A	Smart datalink converter.
16	15A	Tailgate release.
17	5A	HUD.
18	5A	Ignition switch and passive-entry passive-start start stop switch. Key inhibit solenoid.
19	7.5A	Tow haul (O/D) cancel for floor or column shifter.
20	7.5A	Not used.
21	5A	HUD. In car temperature with humidity sensor.
22	5A	EPB. Power seat.
23	10A	PDRG switch. Inverter. Driver side window. Moonroof.
24	20A	Central lock/unlock.
25	30A	Driver door control module.
26	30A	Passenger door control module.
27	30A	Vista roof. Moonroof.
28	20A	Not used.
29	30A	Not used.

Fuses

Fuse or relay number	Fuse amp rating	Protected components
30	30A	Not used.
31	15A	Adjustable pedal switch and motor.
32	10A	Multi-function display. Global position system. Sync 1. Sync 2. Radio frequency receiver.
33	20A	Radio.
34	30A	Run-start relay.
35	5A	Restraints module.
36	15A	360 camera module. Heated steering wheel module. Rear-view mirror. Rear heated seats.
37	15A	Power distribution box run-start relay.
38	30A Circuit breaker.	Rear window switches and motors.

CHANGING A FUSE

Fuses

WARNING



You must replace a failed fuse with one that has the specified amperage rating. If you use a fuse with a higher amperage rating, you may cause severe wire damage and may start a fire.

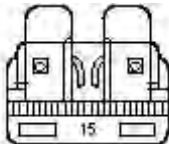

E142430

A fuse may fail if electrical components in the vehicle are not properly working. A broken wire inside the fuse indicates a failed fuse. Check the appropriate fuses before replacing any electrical components.

Maintenance

GENERAL INFORMATION

Have your vehicle serviced regularly to help maintain its roadworthiness and resale value. There is a large network of authorized dealers that are there to help you with their professional servicing expertise. We believe that their specially trained technicians are best qualified to service your vehicle properly and expertly. They are supported by a wide range of highly specialized tools developed specifically for servicing your vehicle.

If your vehicle requires professional service, an authorized dealer can provide the necessary parts and service. Check your warranty information to find out which parts and services are covered.

Use only recommended fuels, lubricants, fluids and service parts conforming to specifications. Motorcraft® parts are designed and built to provide the best performance in your vehicle.

Precautions

- Do not work on a hot engine.
- Make sure that nothing gets caught in moving parts.
- Do not work on a vehicle with the engine running in an enclosed space, unless you are sure you have enough ventilation.
- Keep all open flames and other burning material (such as cigarettes) away from the battery and all fuel related parts.

Working with the Engine Off

1. Set the parking brake and shift to park (P).
2. Switch off the engine.
3. Block the wheels.

Working with the Engine On

WARNING



To reduce the risk of vehicle damage and/or personal burn injuries, do not start your engine with the air cleaner removed and do not remove it while the engine is running.

1. Set the parking brake and shift to park (P).
2. Block the wheels.

OPENING AND CLOSING THE HOOD

1. Inside the vehicle, pull the hood release handle located under the left hand side of the instrument panel.



E166491

2. Go to the front of your vehicle and locate the secondary release lever under the front of the hood near the center of your vehicle.

Maintenance

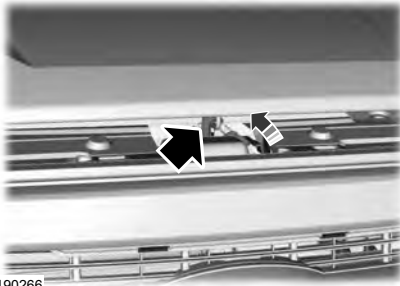

E190266

3. Raise the hood until the lift cylinders hold it open.
4. To close, lower the hood and make sure that it is closed properly and fully latched.

UNDER HOOD OVERVIEW - 2.7L ECOBOOST™

2.7L EcoBoost

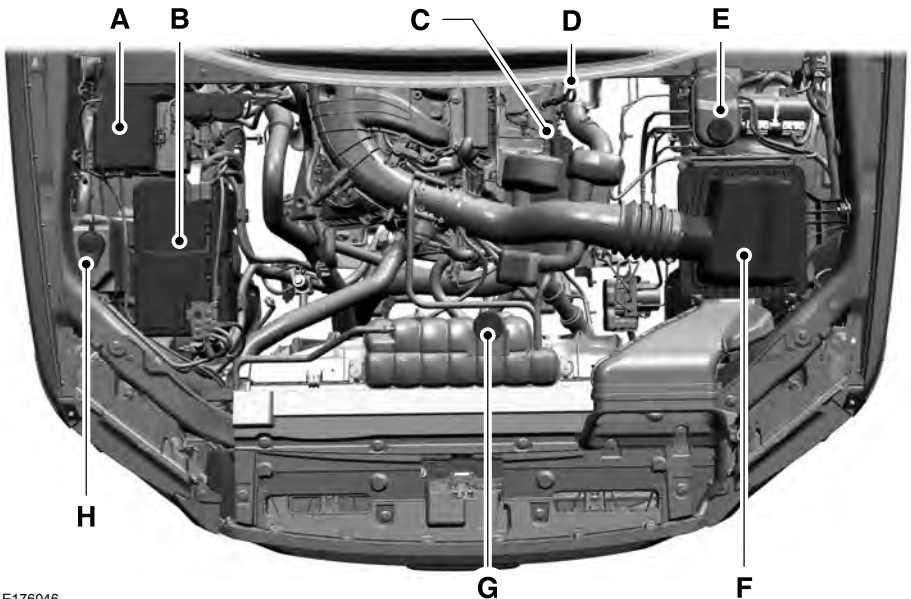

E176046

Maintenance

- A. Power distribution box. See **Fuses** (page 289).
- B. Battery. See **Changing the 12V Battery** (page 309).
- C. Engine oil filler cap. See **Engine Oil Check** (page 303).
- D. Engine oil dipstick. See **Engine Oil Dipstick** (page 303).
- E. Brake fluid reservoir. See **Brake Fluid Check** (page 309).
- F. Air filter assembly. See **Changing the Engine Air Filter** (page 320).
- G. Engine coolant reservoir. See **Engine Coolant Check** (page 304).
- H. Windshield washer fluid reservoir. See **Washer Fluid Check** (page 309).

UNDER HOOD OVERVIEW - 3.5L ECOBOOST™

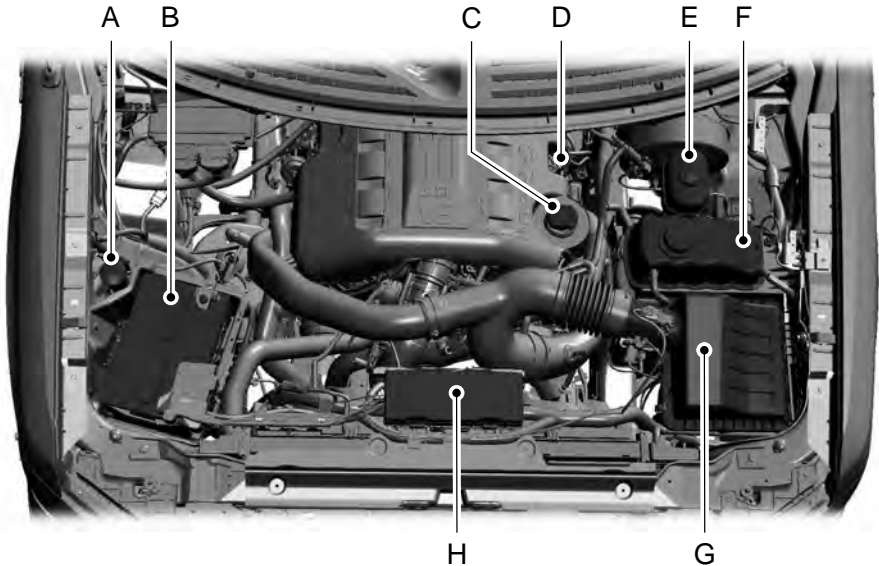

E166496

- A. Windshield washer fluid reservoir. See **Washer Fluid Check** (page 309).
- B. Battery. See **Changing the 12V Battery** (page 309).
- C. Engine oil filler cap. See **Engine Oil Check** (page 303).

Maintenance

- D. Engine oil dipstick. See **Engine Oil Dipstick** (page 303).
- E. Brake fluid reservoir. See **Brake Fluid Check** (page 309).
- F. Engine coolant reservoir. See **Engine Coolant Check** (page 304).
- G. Air filter assembly. See **Changing the Engine Air Filter** (page 320).
- H. Power distribution box. See **Fuses** (page 289).

UNDER HOOD OVERVIEW - 3.5L

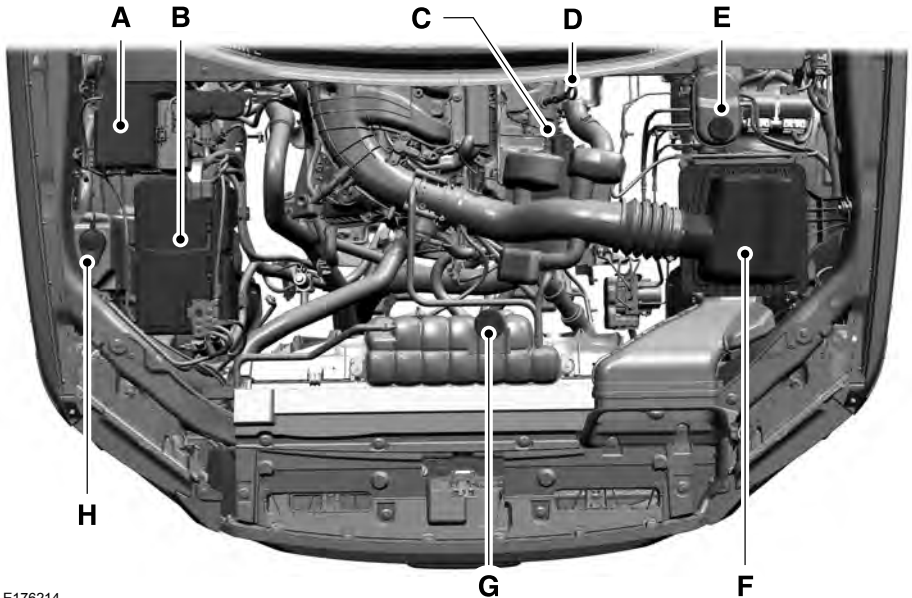

E176214

- A. Power distribution box. See **Fuses** (page 289).
- B. Battery. See **Changing the 12V Battery** (page 309).
- C. Engine oil filler cap. See **Engine Oil Check** (page 303).
- D. Engine oil dipstick. See **Engine Oil Dipstick** (page 303).
- E. Brake fluid reservoir. See **Brake Fluid Check** (page 309).
- F. Air filter assembly. See **Changing the Engine Air Filter** (page 320).

Maintenance

- G. Engine coolant reservoir. See **Engine Coolant Check** (page 304).
- H. Windshield washer fluid reservoir. See **Washer Fluid Check** (page 309).

UNDER HOOD OVERVIEW - 5.0L

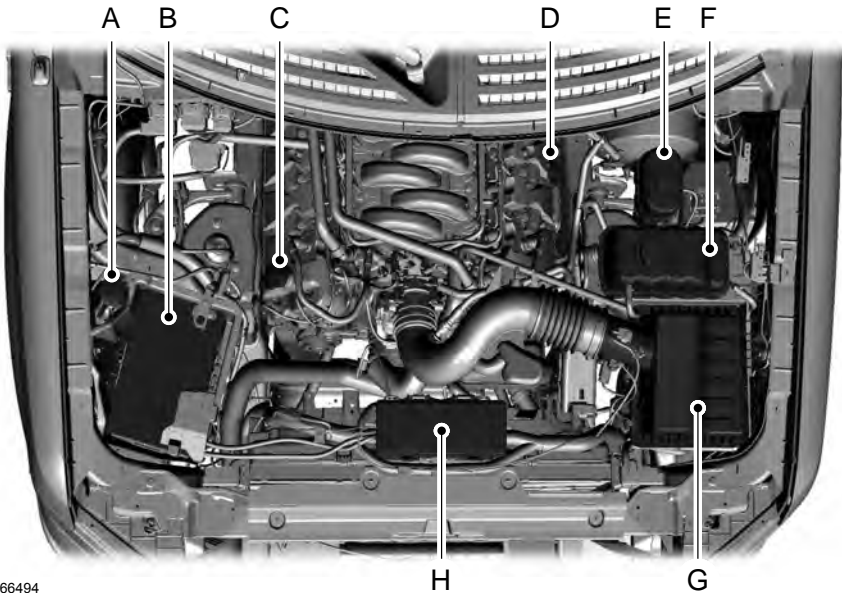

E166494

- A. Windshield washer fluid reservoir. See **Washer Fluid Check** (page 309).
- B. Battery. See **Changing the 12V Battery** (page 309).
- C. Engine oil filler cap. See **Engine Oil Check** (page 303).
- D. Engine oil dipstick. See **Engine Oil Dipstick** (page 303).
- E. Brake fluid reservoir. See **Brake Fluid Check** (page 309).
- F. Engine coolant reservoir. See **Engine Coolant Check** (page 304).
- G. Air filter assembly. See **Changing the Engine Air Filter** (page 320).
- H. Power distribution box. See **Fuses** (page 289).

Maintenance

ENGINE OIL DIPSTICK



E161560

A MIN
B MAX

ENGINE OIL CHECK

1. Make sure that your vehicle is on level ground.
2. Switch the engine off and wait 15 minutes for the oil to drain into the oil pan.
3. Set the parking brake and ensure the gearshift is in park (P).
4. Open the hood. Protect yourself from engine heat.
5. Locate and carefully remove the engine oil level dipstick. See **Under Hood Overview** (page 301).
6. Wipe the dipstick clean. Insert the dipstick fully, then remove it again.
 - If the oil level is between the lower and upper holes, the oil level is acceptable. **DO NOT ADD OIL.**
 - If the oil level is below the lower hole, add enough oil to raise the level within the lower and upper holes.
 - Oil levels above the upper hole may cause engine damage. Some oil must be removed from the engine by an authorized dealer.
7. Put the oil level dipstick back into the oil dipstick tube and ensure it is fully seated.

Adding Engine Oil

Note: Do not remove the filler cap when the engine is running.

Note: Do not remove the engine oil level dipstick when the engine is running.

Note: Do not add oil further than the MAX mark. Oil levels above the MAX mark may cause engine damage.



E142732

Maintenance

Only use oils certified for gasoline engines by the American Petroleum Institute (API). An oil with this trademark symbol conforms to the current engine and emission system protection standards and fuel economy requirements of the International Lubricants Specification Advisory Council (ILSAC), comprised of U.S. and Japanese automobile manufacturers.

1. Check the engine oil level.
2. If the engine oil level is not within the normal range, add engine oil that meets Ford specifications. See **Capacities and Specifications** (page 361).
3. Remove the engine oil filler cap and use a funnel to pour the engine oil into the opening.
4. Wipe off any spilled oil.
5. Recheck the engine oil level. Make sure the oil level is not above the normal operating range on the engine oil level dipstick.
6. Install the engine oil level dipstick and ensure it is fully seated.
7. Fully install the engine oil filler cap by turning the filler cap clockwise until three clicks are heard or until the cap is fully seated.

ENGINE COOLANT CHECK

WARNINGS



Do not add engine coolant when the engine is hot. Steam and scalding liquids released from a hot cooling system can burn you badly. Also, spilling coolant on hot engine parts can burn you.



Do not put engine coolant in the windshield washer fluid container. If sprayed on the windshield, engine coolant could make it difficult to see through the windshield.

WARNINGS



To reduce the risk of personal injury, make sure the engine is cool before unscrewing the coolant pressure relief cap. The cooling system is under pressure. Steam and hot liquid can come out forcefully when you loosen the cap slightly.



Do not add coolant further than the **MAX** mark.

Checking the Engine Coolant

When the engine is cold, check the concentration and level of the engine coolant at the intervals listed in the scheduled maintenance information. See **Scheduled Maintenance** (page 501).

Note: Make sure that the coolant level is between the **MIN** and **MAX** marks on the coolant reservoir.

Note: Coolant expands when it is hot. The level may extend beyond the **MAX** mark.

Note: If the level is at the **MIN** mark, below the **MIN** mark, or empty, add coolant immediately.

Maintain coolant concentration within 48% to 50%, which equates to a freeze point between -30°F (-34°C) and -34°F (-37°C).

Note: For best results, coolant concentration should be tested with a refractometer such as Robinair® Coolant and Battery Refractometer 75240. We do not recommend the use of hydrometers or coolant test strips for measuring coolant concentrations.

Note: Automotive fluids are not interchangeable. Do not use engine coolant, antifreeze or windshield washer fluid outside of its specified function and vehicle location.

Maintenance

Adding Engine Coolant

Note: Do not use stop leak pellets, cooling system sealants or additives as they can cause damage to the engine cooling or heating systems. Your warranty may not cover these damages.

Note: During normal vehicle operation, the coolant may change color from orange to pink or light red. As long as the coolant is clear and uncontaminated, this color change does not indicate the coolant has degraded nor does it require the coolant to be drained, the system to be flushed, or the coolant to be replaced.

Do not mix different colors or types of coolant in your vehicle. Mixing of engine coolants may harm your engine's cooling system. Use prediluted engine coolant meeting the correct specification. See **Capacities and Specifications** (page 361). The use of an incorrect coolant may harm the engine or cooling system components and may not be covered by the vehicle Warranty.

In case of emergency, you can add a large amount of water without engine coolant in order to reach a vehicle service location. In this instance, qualified personnel:

1. Must drain the cooling system.
2. Chemically clean the cooling system with Motorcraft Premium Cooling System Flush.
3. Refill with engine coolant as soon as possible.

Water alone, without engine coolant, can cause engine damage from corrosion, overheating or freezing.

Do not use the following as a coolant substitute:

- Alcohol.
- Methanol.

- Brine.
- Any engine coolant mixed with alcohol or methanol antifreeze or coolant.

Alcohol and other liquids can cause engine damage from overheating or freezing.

Do not add extra inhibitors or additives to the coolant. These can be harmful and compromise the corrosion protection of the engine coolant.

When adding coolant:

1. Unscrew the cap slowly. Any pressure will escape as you unscrew the cap.
2. Add prediluted engine coolant meeting the correct specification. See **Capacities and Specifications** (page 361).
3. Check the coolant level in the coolant reservoir the next few times you drive your vehicle.
4. If necessary, add enough prediluted engine coolant to bring the coolant level to the proper level.

Recycled Engine Coolant

We do not recommend the use of recycled engine coolant as an approved recycling process is not yet available.

Used engine coolant should be disposed of in an appropriate manner. Follow your community's regulations and standards for recycling and disposing of automotive fluids.

Maintenance

Severe Climates

If you drive in extremely cold climates:

- It may be necessary to have an authorized dealer increase the coolant concentration above 50%.
- A coolant concentration of 60% provides improved freeze point protection. Engine coolant concentrations above 60% decrease the overheat protection characteristics of the engine coolant and may cause engine damage.

If you drive in extremely hot climates:

- It may be necessary to have an authorized dealer decrease the coolant concentration to 40%.
- A coolant concentration of 40% provides improved overheat protection. Engine coolant concentrations below 40% decrease the freeze and corrosion protection characteristics of the engine coolant and may cause engine damage.

Vehicles driven year-round in non-extreme climates should use prediluted engine coolant for optimum cooling system and engine protection.

What You Should Know About Fail-Safe Cooling

If you deplete the engine coolant supply, fail-safe cooling allows you to temporarily drive your vehicle before you incur incremental component damage. The fail-safe distance depends on ambient temperatures, vehicle load and terrain.

How Fail-Safe Cooling Works

If the engine begins to overheat, the engine coolant temperature gauge will move to the red (hot) area and:



the coolant temperature warning light will illuminate



the service engine soon indicator will illuminate.

If the engine reaches a preset over-temperature condition, the engine automatically switches to alternating cylinder operation. Each disabled cylinder acts as an air pump and cools the engine.

When this occurs, your vehicle will still operate. However:

- The engine power will be limited.
- This will disable the air conditioning system.

Continued operation increases the engine temperature, causing the engine to completely shut down. Your steering and braking effort increases in this situation.

When the engine temperature cools, you can re-start your engine. Take your vehicle to an authorized dealer as soon as possible to minimize engine damage.

When Fail-Safe Mode Is Activated

WARNINGS



Fail-safe mode is for use during emergencies only. Operate your vehicle in fail-safe mode only as long as necessary to bring your vehicle to rest in a safe location and seek immediate repairs. When in fail-safe mode, your vehicle will have limited power, will not be able to maintain high-speed operation, and may completely shut down without warning, potentially losing engine power, power steering assist, and power brake assist, which may increase the possibility of a crash resulting in serious injury.



Never remove the coolant reservoir cap while the engine is running or hot.

Maintenance

You have limited engine power when in the fail-safe mode, so drive your vehicle with caution. Your vehicle will not maintain high-speed operation and the engine will operate poorly.

Remember that the engine is capable of automatically shutting down to prevent engine damage. In this situation:

1. Pull off the road as soon as safely possible and switch off the engine.
2. Tow your vehicle to an authorized dealer.
3. If this is not possible, wait a short period for the engine to cool.
4. Check the coolant level and add if low.
5. Re-start the engine and drive your vehicle to an authorized dealer.

Note: *Driving your vehicle without repair increases the chance of engine damage. Contact an authorized dealer as soon as possible.*

Engine Fluid Temperature Management (If Equipped)

WARNINGS



To reduce the risk of crash and injury, be prepared that the vehicle speed may reduce and the vehicle may not be able to accelerate with full power until the fluid temperatures reduce.



Never remove the coolant reservoir cap while the engine is running or hot.

Your vehicle can pull a trailer, but because of the added load, your vehicle's engine may temporarily reach higher temperatures during severe operating conditions such as ascending a long or steep grade while pulling a trailer in high temperatures.

At this time, you may notice your engine coolant temperature gauge needle move toward the **H** and the **POWER REDUCED TO LOWER TEMP** message may appear in the information display.

You may notice a reduction in vehicle speed caused by reduced engine power. In order to manage the engine fluid temperatures, your vehicle may enter this mode if certain high-temperature and high-load conditions take place. The amount of speed reduction depends on many factors such as vehicle loading, towing, grade and ambient temperature. If this occurs, there is no need to pull off the road. You can continue to drive your vehicle while this message is active.

The air conditioning may also cycle on and off during severe operating conditions to protect overheating of the engine. When the engine coolant temperature decreases to a normal operating temperature, the air conditioning will turn on once again.

If the engine coolant temperature gauge moves fully into the red (hot) area, or if the coolant temperature warning or service engine soon messages appear in your information display:

1. Pull off the road as soon as safely possible and shift the transmission into **P**.
2. Leave the engine running until the coolant temperature gauge needle moves away from the red (hot) area. After several minutes, if the temperature does not drop, follow the remaining steps.
3. Switch the engine off and wait for it to cool before checking the coolant level.
4. If the coolant level is normal, restart your engine and continue.

Maintenance

- If the coolant is low, add coolant, and restart the engine. See **Adding Engine Coolant** or **How Fail-Safe Cooling Works** in this chapter for more information.

AUTOMATIC TRANSMISSION FLUID CHECK

If required, have an authorized dealer check and change the transmission fluid at the correct service interval. See **Scheduled Maintenance** (page 501).

The automatic transmission does not have a transmission fluid dipstick.

Refer to your scheduled maintenance information for scheduled intervals for fluid checks and changes. Your transmission does not consume fluid. However, if the transmission slips, shifts slowly or if you notice a sign of leaking fluid, contact an authorized dealer.

Do not use supplemental transmission fluid additives, treatments or cleaning agents. The use of these materials may affect transmission operation and result in damage to internal transmission components.

TRANSFER CASE FLUID CHECK

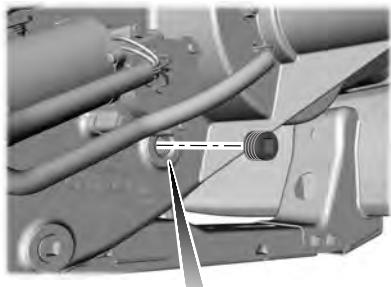

E170444

- Clean the filler plug.
- Remove the filler plug.
- Inspect the fluid level. The fluid level should be within 0.12 in (3 mm) from the bottom of the hole.
- Add fluid through the filler hole.

Use only fluid that meets Ford specifications. See **Capacities and Specifications** (page 361).

Maintenance

BRAKE FLUID CHECK

Fluid levels between the MIN and MAX lines are within the normal operating range; there is no need to add fluid. If the fluid levels are outside of the normal operating range, the performance of the system could be compromised; seek service from your authorized dealer immediately.

POWER STEERING FLUID CHECK

Your vehicle is equipped with an electric power steering (EPS) system. There is no fluid reservoir to check or fill.

WASHER FLUID CHECK

WARNING



If you operate your vehicle in temperatures below 40°F (5°C), use washer fluid with antifreeze protection. Failure to use washer fluid with antifreeze protection in cold weather could result in impaired windshield vision and increase the risk of injury or accident.

Add fluid to fill the reservoir if the level is low. Only use a washer fluid that meets Ford specifications. See **Capacities and Specifications** (page 361).

State or local regulations on volatile organic compounds may restrict the use of methanol, a common windshield washer antifreeze additive. Washer fluids containing non-methanol antifreeze agents should be used only if they provide cold weather protection without damaging the vehicle's paint finish, wiper blades or washer system.

FUEL FILTER

Your vehicle is equipped with a lifetime fuel filter that is integrated with the fuel tank. Regular maintenance or replacement is not needed.

CHANGING THE 12V BATTERY

WARNINGS



Batteries normally produce explosive gases which can cause personal injury. Therefore, do not allow flames, sparks or lighted substances to come near the battery. When working near the battery, always shield your face and protect your eyes. Always provide correct ventilation.



When lifting a plastic-cased battery, excessive pressure on the end walls could cause acid to flow through the vent caps, resulting in personal injury and damage to the vehicle or battery. Lift the battery with a battery carrier or with your hands on opposite corners.



Keep batteries out of reach of children. Batteries contain sulfuric acid. Avoid contact with skin, eyes or clothing. Shield your eyes when working near the battery to protect against possible splashing of acid solution. In case of acid contact with skin or eyes, flush immediately with water for a minimum of 15 minutes and get prompt medical attention. If acid is swallowed, call a physician immediately.



Battery posts, terminals and related accessories contain lead and lead compounds. Wash hands after handling.

Maintenance

WARNINGS



This vehicle may be fitted with more than one battery. Removing the battery cables from only one battery does not disconnect your vehicle electrical system. Make sure you disconnect the battery cables from all batteries when disconnecting power. Failure to do so may cause serious personal injury or property damage.

Your vehicle is fitted with a Motorcraft maintenance-free battery which normally does not require additional water.

When a battery replacement is required, you must use a recommended replacement battery that matches the electrical requirements of the vehicle.

Note: *After cleaning or replacing the battery, make sure you reinstall the battery cover or shield.*

Note: *If you add electrical accessories or components to the vehicle, it may adversely affect the low voltage battery performance and durability. This may also affect the performance of other electrical systems in the vehicle.*

For longer, trouble-free operation, keep the top of the battery clean and dry.

If you see any corrosion on the battery or terminals, remove the cables from the terminals and clean with a wire brush. You can neutralize the acid with a solution of baking soda and water.

Because your vehicle's engine is electronically controlled by a computer, some control conditions are maintained by power from the battery. When the battery is disconnected or a new battery is installed, the engine must relearn its idle and fuel trim strategy for optimum driveability and performance. Flexible fuel vehicles (FFV) must also relearn the ethanol content of the fuel for optimum driveability and performance.

To restore the settings, do the following:

1. Apply the parking brake.
2. Shift into park (P) or neutral (N).
3. Switch off all accessories.
4. Press the brake pedal and start your vehicle.
5. Run the engine until it reaches normal operating temperature. While the engine is warming up, complete the following: Reset the clock. See **Audio System** (page 383). Reset the power windows bounce-back feature. See **Audio System** (page 383). Reset the radio station presets. See **Audio System** (page 383).
6. Allow the engine to idle for at least one minute.
7. Drive the vehicle at least 10 mi (16 km) to completely relearn the idle trim and fuel trim strategy.

Note: *If you do not allow the engine to relearn the idle and fuel trim strategy, the idle quality of your vehicle may be adversely affected until the engine computer eventually relearns the idle trim and fuel trim strategy.*

Note: *For flexible fuel vehicles, if you are operating on E85, you may experience poor starts or an inability to start the engine and driveability problems until the fuel trim and ethanol content have been relearned.*

Maintenance

Make sure that you dispose of old batteries in an environmentally friendly way. Seek advice from your local authority about recycling old batteries.

If storing your vehicle for more than 30 days without recharging the battery, we recommend that you disconnect the battery cables to maintain battery charge for quick starting.

Battery Management System (if Equipped)

The battery management system monitors battery conditions and takes actions to extend battery life. If excessive battery drain is detected, the system temporarily disables some electrical systems to protect the battery.

Systems included are:

- Heated rear window.
- Heated seats.
- Climate control.
- Heated steering wheel.
- Audio unit.
- Navigation system.

A message may appear in the information displays to alert you that battery protection actions are active. These messages are only for notification that an action is taking place, and not intended to indicate an electrical problem or that the battery requires replacement.

After battery replacement, or in some cases after charging the battery with an external charger, the battery management system requires eight hours of vehicle sleep time to relearn the battery state of charge. During this time your vehicle must remain fully locked with the ignition switched off.

Note: *Prior to relearning the battery state of charge, the battery management system may temporarily disable some electrical systems.*

Electrical Accessory Installation

To make sure the battery management system works correctly, do not connect an electrical device ground connection directly to the battery negative post. This can cause inaccurate measurements of the battery condition and potential incorrect system operation.

Note: *If you add electrical accessories or components to the vehicle, it may adversely affect battery performance and durability. This may also affect the performance of other electrical systems in the vehicle.*

CHECKING THE WIPER BLADES



E142463

Run the tip of your fingers over the edge of the blade to check for roughness.

Clean the wiper blades with washer fluid or water applied with a soft sponge or cloth.

CHANGING THE WIPER BLADES

Note: *Do not hold the wiper blade when lifting the wiper arm.*

Maintenance



E165804

1. Pull the wiper blade and arm away from the glass.

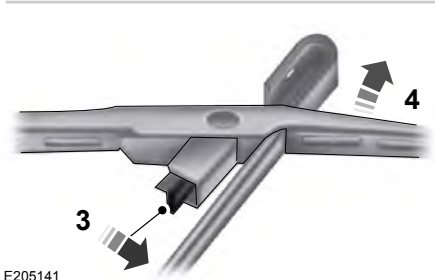
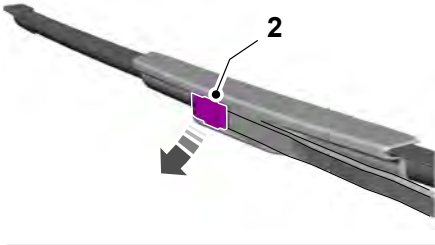

E205141

2. Lift the wiper blade primary locking clip.
3. Press the wiper blade secondary locking clip.
4. Remove the wiper blade.

Note: Make sure that the wiper arm does not spring back against the glass when the wiper blade is not attached.

5. Install in the reverse order.

Note: Make sure that the wiper blade locks into place.

ADJUSTING THE HEADLAMPS

Vertical Aim Adjustment

The headlamps on your vehicle are properly aimed at the assembly plant. If your vehicle has been in an accident, contact an authorized dealer to check and realign your headlamps.

Headlamp Aiming Target

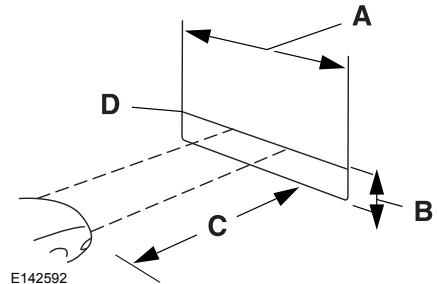

E142592

- A 8 feet (2.4 meters).
- B Center height of lamp to ground.
- C 25 feet (7.6 meters).
- D Horizontal reference line.

Vertical Aim Adjustment

1. Park your vehicle directly in front of a wall or screen on a level surface, approximately 25 feet (7.6 meters) away.

Maintenance

2. Measure the height from the center of your headlamp (indicated by a 3.0 millimeter circle on the lens) to the ground and mark an 8 foot (2.4 meter) horizontal reference line on the vertical wall or screen at this height (a piece of masking tape works well).

Note: To see a clearer light pattern for adjusting, you may want to block the light from one headlamp while adjusting the other.

3. Switch on the low beam headlamps to illuminate the wall or screen and open the hood. Cover one of the headlamps so no light hits the wall.



E167358

4. **For halogen or LED headlamps:** On the wall or screen you will observe a light pattern with a distinct horizontal edge toward the right. If this edge is not at the horizontal reference line, you will need to adjust the beam so the edge is at the same height as the horizontal reference line.



E163806

5. Locate the vertical adjuster on each headlamp. Use a #2 Phillips screwdriver to turn the adjuster either counterclockwise or clockwise in order to adjust the vertical aim of the headlamp.
6. Repeat Steps 3 through 7 to adjust the other headlamp.
7. Close the hood and turn off the lamps.

Horizontal Aim Adjustment

Horizontal aim is not required for this vehicle and is not adjustable.

CHANGING A BULB

WARNING



Handle a halogen headlamp bulb carefully and keep out of children's reach. Grasp the bulb only by its plastic base and do not touch the glass. The oil from your hand could cause the bulb to break the next time the headlamps are operated.

Note: If the bulb is accidentally touched, clean it with rubbing alcohol before installing it.

Maintenance

Lamp Assembly Condensation

Exterior lamps are vented to accommodate normal changes in pressure. Condensation can be a natural by-product of this design. When moist air enters the lamp assembly through the vents, there is a possibility that condensation can occur when the temperature is cold. When normal condensation occurs, a thin film of mist can form on the interior of the lens. The thin mist eventually clears and exits through the vents during normal operation. Clearing time may take as long as 48 hours under dry weather conditions.

Examples of acceptable condensation are:

- Presence of thin mist (no streaks, drip marks or droplets).
- Fine mist covers less than 50% of the lens.

Examples of unacceptable moisture (usually caused by a lamp water leak) are:

- Water puddle inside the lamp.
- Large water droplets, drip marks or streaks present on the interior of the lens.

Take your vehicle to a dealer for service if any of the above conditions of unacceptable moisture are present.

Accessing the Halogen High Beam, Low Beam and Direction Indicator Bulbs

1. Rotate the steering wheel to the opposite side of the bulb needing replacement.
2. Remove two screws and one push pin from the front of the wheel liner.

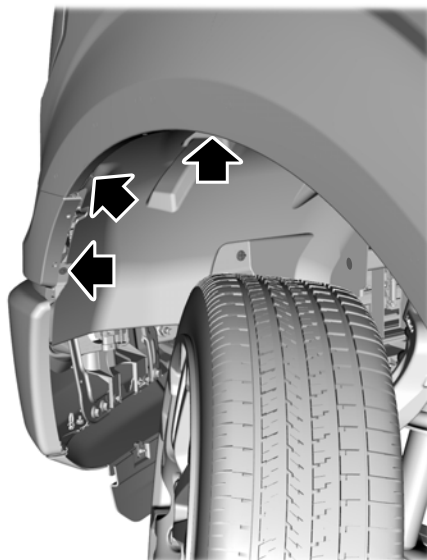

E183762

3. Pull the wheel liner back towards the tire to gain access to the bulbs.

Maintenance

Replacing the Halogen High Beam, Low Beam and Direction Indicator Bulbs

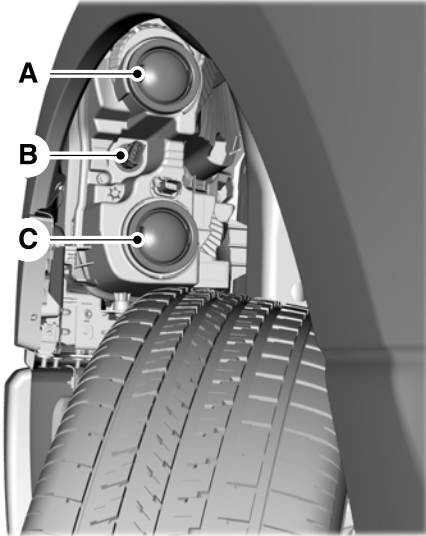

E183500

- A. Low beam headlamp bulb.
- B. Direction indicator bulb.
- C. High beam headlamp bulb.



E183763

1. Make sure the headlamps are off.
2. For the high beam and low beam bulbs, remove the rubber cap to access the bulbs.
3. Remove the bulb holder from the lamp assembly by turning it counterclockwise and pulling it straight out.
4. Disconnect the bulb from the electrical connector.
5. Install the new bulb in reverse order.

Maintenance

Replacing Side Marker Bulb

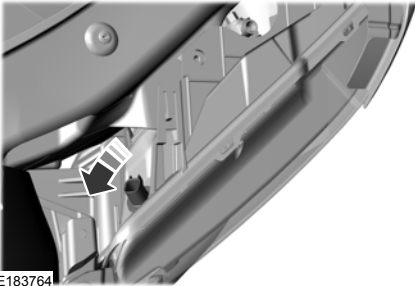

E183764

1. Make sure the headlamps are off.
2. With the hood open, locate the side marker on the top of the headlamp assembly.
3. Remove the bulb holder from the lamp assembly by turning it counterclockwise and pulling it straight out.
4. Install the new bulb in reverse order.

Replacing Fog Lamp Bulbs (If Equipped)

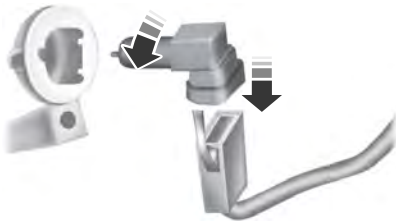

E163826

1. Make sure the fog lamps are off.
2. Disconnect the electrical connector from the fog lamp bulb.
3. Turn the bulb counterclockwise and remove it from the fog lamp.
4. Install the new bulb in reverse order.

Replacing LED Headlamp Bulbs (If Equipped)

These lamps have LED bulbs. Contact an authorized dealer.

Replacing LED Direction Indicator and Side Marker Bulbs (If Equipped)

These lamps have LED bulbs. Contact an authorized dealer.

Replacing Brake, Rear, Direction Indicator and Reverse Lamp Bulbs

1. Make sure the headlamps are off.
2. Open the tailgate to access the rear lamp assemblies

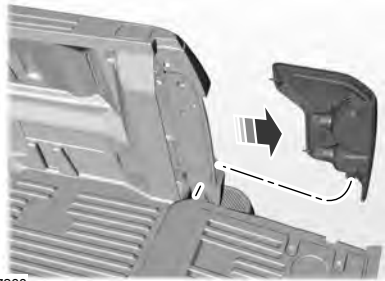

E187288

3. Remove the two bolts from the tail lamp assembly. Then, carefully pull the lamp assembly from the tailgate pillar by releasing the two retaining tabs.
4. Disconnect the electrical connector from the bulb.

Maintenance

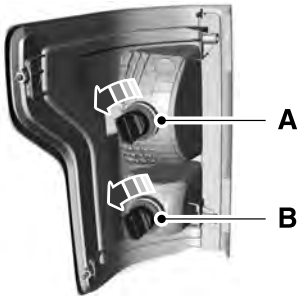

E187289

- A. Brake, rear and direction indicator bulb.
 - B. Reverse lamp bulb.
1. Rotate the bulb socket counterclockwise and remove it from the rear lamp assembly.
 2. Install the new bulb in reverse order.

Replacing LED Brake, Rear, Direction Indicator and Reverse Lamp Bulbs (If Equipped)

These lamps have LED bulbs. Contact an authorized dealer.

Replacing Cargo Lamp and High-mount Brake Lamp Bulbs

1. Make sure the lamps are off.
2. Remove the four screws and move the lamp assembly away from the vehicle to expose the bulb sockets.



E187290

3. Remove the bulb socket by rotating it counterclockwise and pulling it out of the lamp assembly.
4. Pull the bulb straight out of the socket.
5. Install the new bulb in reverse order.

Replacing LED Cargo Lamp, Spot Lamp and High-mount Brake Lamp Bulbs (If Equipped)

These lamps have LED bulbs. Contact an authorized dealer.

Replacing the License Plate Lamp Bulb

Note: The license plate bulbs are located behind the rear bumper.



E187794

1. Reach behind the rear bumper to locate the bulb.

Maintenance

2. Twist the bulb socket counterclockwise and carefully pull to remove it from the lamp assembly.
3. Pull the bulb straight out of the socket.
4. Install the new bulb in reverse order.

Replacing Exterior Mounted Mirror Direction Indicator Lamp Bulbs

These lamps have LED bulbs. Contact an authorized dealer.

BULB SPECIFICATION CHART

Replacement bulbs are specified in the chart below. Headlamp bulbs must be marked with an authorized D.O.T. marking for North America to make sure they have the proper lamp performance, light brightness, light pattern and safe visibility. The correct bulbs will not damage the lamp assembly or void the lamp assembly warranty and will provide quality bulb illumination time.

Exterior Lamps

Lamp	Specification	Power (Watt)
Front direction indicator and parking lamps.	7444NA	21/5W
Daytime running lamps.	LED	LED
Headlamp high beam.	9005	65W
Headlamp low beam.	H11	55W
Front fog lamps.	9140	55W
Front side marker lamps.	W5W	5W
Side direction indicator.	LED	LED
Puddle lamp.	LED	LED
Rear lamps, brake lamps, rear direction indicator and rear side marker lamps.*	3157	27/8W
Central high mounted brake lamp.*	921	16W
Central high mounted brake lamp. Vehicles with cargo box.	LED	LED
Reversing lamps.	3156K	27W
License plate lamp.	168	5W

*May have optional LED lamps.

Note: LED lamps are not serviceable. See an authorized dealer if they fail.

Maintenance

Interior Lamps

Lamp	Specification	Power (Watt)
Glove compartment lamp.	LED	LED
Map lamp.	LED	LED
Rear dome and courtesy lamps.	LED	LED
Rear cargo box lamps.	LED	LED

Note: LED lamps are not serviceable. See an authorized dealer if they fail.

Maintenance

CHANGING THE ENGINE AIR FILTER

WARNING



To reduce the risk of vehicle damage and personal burn injuries, do not start your engine with the air cleaner removed and do not remove it while the engine is running.

Note: Failure to use the correct air filter element may result in severe engine damage. Resulting component damage may not be covered by the vehicle Warranty.

Note: When servicing the air cleaner, do not allow foreign material to enter the air induction system. The engine is susceptible to damage from even small particles.

When changing the air filter element, use only the air filter element listed. See **Capacities and Specifications** (page 361).

Change the air filter element at the proper intervals. See **Scheduled Maintenance** (page 501).

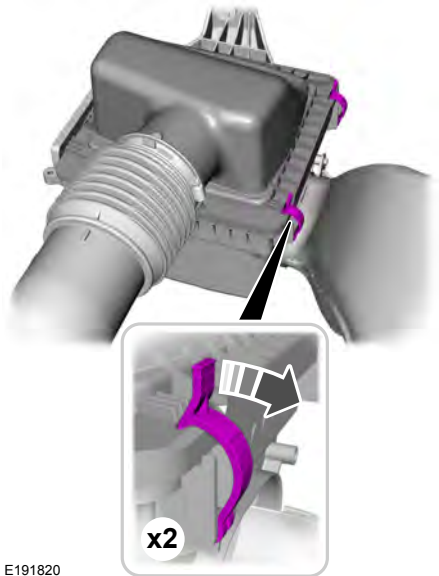

E191820

1. Release the clamps that secure the air filter cover to the housing.
2. Carefully lift the air filter housing cover.
3. Remove the air filter element from the air filter housing.
4. Install in the reverse order.

Vehicle Care

GENERAL INFORMATION

Your Ford or Lincoln authorized dealer has many quality products available to clean your vehicle and protect its finishes.

Materials

Name	Specification
Motorcraft Bug and Tar Remover ZC-42	-
Motorcraft Custom Bright Metal Cleaner ZC-15	-
Motorcraft® Detail Wash ZC-3-A	ESR-M14P4-A
Motorcraft Engine Shampoo and Degreaser (U.S.) ZC-20 (U.S.)	-
Engine Shampoo	-
Motorcraft Leather and Vinyl Cleaner ZC-56	-
Multi-Purpose Cleaner	-
Motorcraft® Premium Windshield Wash Concentrate with Bitterant (U.S.) ZC-32-B2 (U.S.)	WSS-M14P19-A
Professional Strength Carpet and Upholstery Cleaner ZC-54	-
Motorcraft Spot and Stain Remover (U.S.) ZC-14 (U.S.)	-
Motorcraft® Ultra-Clear Spray Glass Cleaner (U.S.) ZC-23 (U.S.)	ESR-M14P5-A
Motorcraft® Wheel and Tire Cleaner ZC-37-A	-

CLEANING PRODUCTS

For best results, use the following products or products of equivalent quality:

CLEANING THE EXTERIOR

Wash your vehicle regularly with cool or lukewarm water and a neutral pH shampoo, we recommend Motorcraft Detail Wash.

- Never use strong household detergents or soap, for example dish washing or laundry liquid. These products can discolor and spot painted surfaces.
- Never wash your vehicle when it is hot to the touch, or during strong or direct sunlight.
- Dry your vehicle with a chamois or soft terry cloth towel to eliminate water spotting.

Vehicle Care

- Immediately remove fuel spillages, bird droppings, insect deposits and road tar. These may cause damage to your vehicle's paintwork or trim over time. We recommend Motorcraft Bug and Tar Remover.
- Remove any exterior accessories, for example antennas, before entering a car wash.
- Do not use water pressure higher than 2,000 psi (14,000 kPa).
- Do not use water hotter than 179°F (82°C).
- Use a spray with a 40° wide spray angle pattern.
- Keep the nozzle at a 12 in (305 mm) distance and 90° angle to your vehicle's surface.

Note: *Suntan lotions and insect repellents can damage painted surfaces. If these substances come in contact with your vehicle, wash the affected area as soon as possible.*

Exterior Chrome Parts

- Apply a high quality-cleaning product to bumpers and other chrome parts. Follow the manufacturer's instructions. We recommend Motorcraft Custom Bright Metal Cleaner.
- Do not apply the cleaning product to hot surfaces. Do not leave the cleaning product on chrome surfaces longer than the time recommended.
- Using other non-recommended cleaners can result in severe and permanent cosmetic damage.

Note: *Never use abrasive materials, for example steel wool or plastic pads as they can scratch the chrome surface.*

Note: *Do not use chrome cleaner, metal cleaner or polish on wheels or wheel covers.*

Exterior Plastic Parts

For routine cleaning we recommend Motorcraft Detail Wash. If tar or grease spots are present, we recommend Motorcraft Bug and Tar Remover.

Stripes or Graphics (If Equipped)

Hand washing your vehicle is preferred however, pressure washing may be used under the following conditions:

Note: *Holding the pressure washer nozzle at an angle to the vehicle's surface may damage graphics and cause the edges to peel away from the vehicle's surface.*

Underbody

Flush the complete underside of your vehicle frequently. Keep body and door drain holes free of debris or foreign material.

WAXING

Regular waxing is necessary to protect your car's paint from the elements. We recommend that you wash and wax the painted surface once or twice a year.

When washing and waxing, park your vehicle in a shaded area out of direct sunlight. Always wash your vehicle before applying wax.

- Use a quality wax that does not contain abrasives.
- Follow the manufacturer's instructions to apply and remove the wax.
- Apply a small amount of wax in a back-and-forth motion, not in circles.

Vehicle Care

- Do not allow wax to come in contact with any non-body (low-gloss black) colored trim. The wax will discolor or stain the parts over time.
 - Roof racks.
 - Bumpers.
 - Grained door handles.
 - Side moldings.
 - Mirror housings.
 - Windshield cowl area.
- Do not apply wax to glass areas.
- After waxing, your car's paint should feel smooth, and be free of streaks and smudges.
- Never wash or rinse any ignition coil, spark plug wire or spark plug well, or the area in and around these locations.
- Cover the battery, power distribution box, and air filter assembly to prevent water damage when cleaning the engine.

CLEANING THE WINDOWS AND WIPER BLADES

Car wash chemicals and environmental fallout can result in windshield and wiper blade contamination. Dirty windshield and wipers will result in poor windshield wiper operation. Keep the windshield and wiper blades clean to maintain windshield wiper performance.

To clean the windshield and wiper blades:

- Clean the windshield with a non-abrasive glass cleaner. When cleaning the interior of the windshield, avoid getting any glass cleaner on the instrument panel or door panels. Wipe any glass cleaner off these surfaces immediately.
- For windshields contaminated with tree sap, chemicals, wax or bugs, clean the entire windshield using steel wool (no greater than 0000 grade) in a circular motion and rinse with water.
- Clean the wiper blades with isopropyl rubbing alcohol or windshield washer concentrate.

Note: Do not use razor blades or other sharp objects to clean or remove decals from the inside of the heated rear window. The vehicle warranty does not cover damage caused to the heated rear window grid lines.

CLEANING THE ENGINE

Engines are more efficient when they are clean because grease and dirt buildup keep the engine warmer than normal.

When washing:

- Take care when using a power washer to clean the engine. The high-pressure fluid could penetrate the sealed parts and cause damage.
- Do not spray a hot engine with cold water to avoid cracking the engine block or other engine components.
- Spray Motorcraft Engine Shampoo and Degreaser on all parts that require cleaning and pressure rinse clean. In Canada, use Motorcraft Engine Shampoo.
- Never wash or rinse the engine while it is hot or running; water in the running engine may cause internal damage.

Vehicle Care

CLEANING THE INTERIOR

WARNINGS



Do not use cleaning solvents, bleach or dye on the vehicle's safety belts, as these actions may weaken the belt webbing.



On vehicles equipped with seat-mounted airbags, do not use chemical solvents or strong detergents. Such products could contaminate the side airbag system and affect performance of the side airbag in a collision.

For fabric, carpets, cloth seats, safety belts and seats equipped with side airbags:

- Remove dust and loose dirt with a vacuum cleaner.
- Remove light stains and soil with Motorcraft Professional Strength Carpet & Upholstery Cleaner.
- If grease or tar is present on the material, spot-clean the area first with Motorcraft Spot and Stain Remover. In Canada, use Motorcraft Multi-Purpose Cleaner.
- If a ring forms on the fabric after spot cleaning, clean the entire area immediately (but do not oversaturate) or the ring will set.
- Do not use household cleaning products or glass cleaners, which can stain and discolor the fabric and affect the flame retardant abilities of the seat materials.

CLEANING THE INSTRUMENT PANEL AND INSTRUMENT CLUSTER LENS

WARNING



Do not use chemical solvents or strong detergents when cleaning the steering wheel or instrument panel to avoid contamination of the airbag system.

Clean the instrument panel and cluster lens with a clean, damp, white cotton cloth, then use a clean and dry white cotton cloth to dry these areas.

- Avoid cleaners or polishes that increase the gloss of the upper portion of the instrument panel. The dull finish in this area helps protect you from undesirable windshield reflection.
- Be certain to wash or wipe your hands clean if you have been in contact with certain products such as insect repellent and suntan lotion in order to avoid possible damage to the interior painted surfaces.
- Do not use household or glass cleaners as these may damage the finish of the instrument panel, interior trim and cluster lens.
- Do not allow air fresheners and hand sanitizers to spill onto interior surfaces. If a spill occurs, wipe off immediately. Damage may not be covered by your warranty.

If a staining liquid like coffee or juice has been spilled on the instrument panel or on interior trim surfaces, clean as follows:

1. Wipe up spilled liquid using a clean, white, cotton cloth.

Vehicle Care

2. Wipe the surface with a damp, clean, white cotton cloth. For more thorough cleaning, use a mild soap and water solution. If the spot cannot be completely cleaned by this method, the area may be cleaned using a commercially available cleaning product designed for automotive interiors.
3. If necessary, apply more soap and water solution or cleaning product to a clean, white, cotton cloth and press the cloth onto the soiled area. Allow this to set at room temperature for 30 minutes.
4. Remove the soaked cloth and if it is not soiled badly, use this cloth to clean the area by using a rubbing motion for 60 seconds.
5. Following this, wipe area dry with a clean, white, cotton cloth.

CLEANING LEATHER SEATS (if Equipped)

Without King Ranch Edition

Note: *Follow the same procedure as cleaning leather seats for cleaning leather instrument panels and leather interior trim surfaces.*

For routine cleaning, wipe the surface with a soft, damp cloth and a mild soap and water solution. Dry the area with a clean, soft cloth.

For cleaning and removing spots and stains such as dye transfer, use Motorcraft Premium Leather and Vinyl Cleaner or a commercially available leather cleaning product for automotive interiors.

Note: *Test any cleaner or stain remover on an inconspicuous area.*

You should:

- Remove dust and loose dirt with a vacuum cleaner.
- Clean and treat spills and stains as soon as possible.

Do not use the following products as these may damage the leather:

- Oil and petroleum or silicone-based leather conditioners.
- Household cleaners.
- Alcohol solutions.
- Solvents or cleaners intended specifically for rubber, vinyl and plastics.

With King Ranch Edition

Your vehicle has seating covered in premium, top-grain leather that is extremely durable, but still requires special care and maintenance in order to preserve longevity and comfort.

Regular cleaning and conditioning maintains the appearance of the leather.

Cleaning

For dirt, use a vacuum cleaner then use a clean, damp cloth or soft brush.

For routine cleaning, wipe the surface with a soft, damp cloth. For more thorough cleaning, wipe the surface with a mild soap and water solution.

- Clean spills as quickly as possible.
- Test any cleaner or stain remover on an inconspicuous part of the leather as cleaners may darken the leather.
- Do not spill coffee, ketchup, mustard, orange juice or oil-based products on the leather as they may permanently stain the leather.
- Do not use household cleaning products, alcohol solutions, solvents or cleaners intended for rubber, vinyl or plastics.

Vehicle Care

Scratches

Because the leather in the seat comes from genuine steer hides, there may be evidence of naturally occurring markings, such as small scars. These markings give character to the seating covers and are considered to be proof of a genuine leather product.

In order to lessen the appearance of certain scratches and other wear marks, apply conditioner on the affected area following the same instructions as in the **Conditioning** section.

Conditioning

Bottles of King Ranch Leather Conditioner are available at the King Ranch Saddle Shop. Visit the website at www.krsaddleshop.com, or call 1-800-282-KING (5464) in the United States. If you are unable to obtain King Ranch Leather Conditioner, use another premium leather conditioner.

- Clean the surfaces using the steps outlined in the Cleaning section.
- Make sure the leather is dry then apply a nickel-sized amount of conditioner to a clean, dry cloth.
- Rub the conditioner into the leather until it disappears. Allow the conditioner to dry, then repeat the process for the entire interior. If a film appears, wipe it off with a dry, clean cloth.

REPAIRING MINOR PAINT DAMAGE

Authorized dealers have touch-up paint to match your vehicle's color. Your vehicle color code is printed on a sticker on the front, left-hand side door jamb. Take your color code to your authorized dealer to make sure you get the correct color.

Before repairing minor paint damage, use a cleaner such as Motorcraft Bug and Tar Remover to remove particles such as bird droppings, tree sap, insect deposits, tar spots, road salt and industrial fallout.

Always read the instructions before using cleaning products.

CLEANING THE ALLOY WHEELS (If Equipped)

Note: Do not apply a cleaning chemical to warm or hot wheel rims and covers.

Note: Some automatic car washes may cause damage to the finish on your wheel rims and covers.

Note: Industrial-strength or heavy-duty cleaners in combination with brush agitation to remove brake dust and dirt, could wear away the clear coat finish over a period time.

Note: Do not use hydrofluoric acid-based or high caustic-based wheel cleaners, steel wool, fuels or strong household detergents.

Note: If you intend parking your vehicle for an extended period after cleaning the wheels with a wheel cleaner, drive your vehicle for a few minutes before doing so. This will reduce the risk of increased corrosion of the brake discs.

Alloy wheels and wheel covers are coated with a clear coat paint finish. To maintain their condition we recommend that you:

- Clean the wheels weekly using Motorcraft Wheel and Tire Cleaner. Apply using manufacturer's instructions.
- Use a sponge to remove heavy deposits of dirt and brake dust accumulation.

Vehicle Care

- Rinse thoroughly with a strong stream of water when you have completed the cleaning process.
- To remove tar and grease, use Motorcraft Bug and Tar Remover.
- Lubricate all hood, door and luggage compartment hinges and latches with a light grade oil.
- Cover interior trim to prevent fading.
- Keep all rubber parts free from oil and solvents.

VEHICLE STORAGE

If you plan on storing your vehicle for 30 days or more, read the following maintenance recommendations to make sure your vehicle stays in good operating condition.

We engineer and test all motor vehicles and their components for reliable, regular driving. Under various conditions, long-term storage may lead to degraded engine performance or failure unless you use specific precautions to preserve engine components.

General

- Store all vehicles in a dry, ventilated place.
- Protect from sunlight, if possible.
- If vehicles are stored outside, they require regular maintenance to protect against rust and damage.

Body

- Wash your vehicle thoroughly to remove dirt, grease, oil, tar or mud from exterior surfaces, rear-wheel housing and the underside of front fenders.
- Periodically wash your vehicle if it is stored in exposed locations.
- Touch-up exposed or primed metal to prevent rust.
- Cover chrome and stainless steel parts with a thick coat of auto wax to prevent discoloration. Re-wax as necessary when you wash your vehicle.

Engine

- Change the engine oil and filter prior to storage because used engine oil contains contaminants which may cause engine damage.
- Start the engine every 15 days for a minimum of 15 minutes. Run at fast idle with the climate controls set to defrost until the engine reaches normal operating temperature.
- With your foot on the brake, shift through all the gears while the engine is running.
- We recommend that you change the engine oil before you use your vehicle again.

Fuel system

- Fill the fuel tank with high-quality fuel until the first automatic shutoff of the fuel pump nozzle.

Cooling system

- Protect against freezing temperatures.
- When removing your vehicle from storage, check coolant fluid level. Confirm that there are no cooling system leaks and that fluid is at the recommended level.

Vehicle Care

Battery

- Check and recharge as necessary. Keep connections clean.
- If storing your vehicle for more than 30 days without recharging the battery, we recommend that you disconnect the battery cables to maintain battery charge for quick starting.

Note: *It is necessary to reset memory features if battery cables are disconnected.*

Brakes

- Make sure the brakes and parking brake release fully.

Tires

- Maintain recommended air pressure.

Miscellaneous

- Make sure all linkages, cables, levers and pins under your vehicle are covered with grease to prevent rust.
- Move vehicles at least 25 ft (7.5 m) every 15 days to lubricate working parts and prevent corrosion.

Removing Vehicle From Storage

When your vehicle is ready to come out of storage, do the following:

- Wash your vehicle to remove any dirt or grease film build-up on window surfaces.
- Check windshield wipers for any deterioration.
- Check under the hood for any foreign material that may have collected during storage such as mice or squirrel nests.
- Check the exhaust for any foreign material that may have collected during storage.

- Check tire pressures and set tire inflation per the Tire Label.
- Check brake pedal operation. Drive your vehicle 15 ft (4.5 m) back and forth to remove rust build-up.
- Check fluid levels (including coolant, oil and gas) to make sure there are no leaks, and fluids are at recommended levels.
- If you remove the battery, clean the battery cable ends and check for damage.

Contact an authorized dealer if you have any concerns or issues.

Wheels and Tires

GENERAL INFORMATION

Notice to utility vehicle and truck owners

WARNINGS



Utility vehicles have a significantly higher rollover rate than other types of vehicles. To reduce the risk of serious injury or death from a rollover or other crash you must avoid sharp turns and abrupt maneuvers, drive at safe speeds for the conditions, keep tires properly inflated, never overload or improperly load your vehicle, and make sure every passenger is properly restrained.



In a rollover crash, an unbelted person is significantly more likely to die than a person wearing a seat belt. All occupants must wear seat belts, and children and infants must use appropriate restraints to minimize the risk of injury or ejection.



Do not become overconfident in the ability of four-wheel drive vehicles. Although a four-wheel drive vehicle may accelerate better than a two-wheel drive vehicle in low traction situations, it won't stop any faster than two-wheel drive vehicles. Always drive at a safe speed.

Utility vehicles and trucks handle differently than passenger cars in the various driving conditions that are encountered on streets, highways and off-road. Utility vehicles and trucks are not designed for cornering at speeds as high as passenger cars any more than low-slung sports cars are designed to perform satisfactorily under off-road conditions.

Study your owner's manual and any supplements for specific information about equipment features, instructions for safe driving and additional precautions to reduce the risk of an accident or serious injury.

Four-wheel drive system (if equipped)

A vehicle equipped with four-wheel drive (when selected) has the ability to use all four wheels to power itself. This increases traction which may enable you to safely drive over terrain and road conditions that a conventional two-wheel drive vehicle cannot.

On some four-wheel drive models, the initial shift from two-wheel drive to four-wheel drive while the vehicle is moving can cause a momentary clunk and ratcheting sound. These sounds are normal as the front drivetrain comes up to speed and are not cause for concern.

How your vehicle differs from other vehicles

Sport utility vehicles and trucks can differ from some other vehicles in a few noticeable ways. Your vehicle may be:



E145298

Wheels and Tires

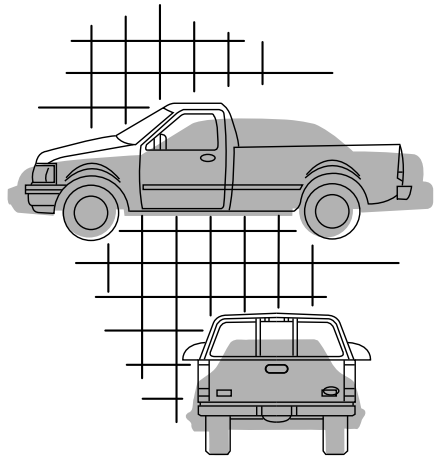
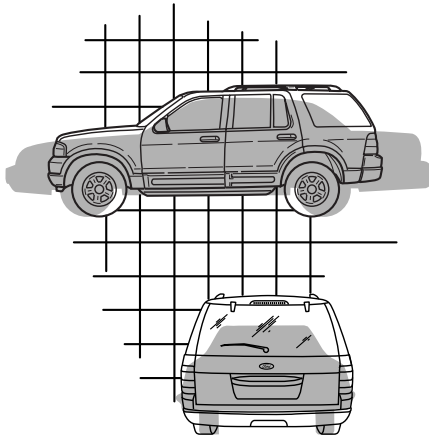

E145299

E168583

- Higher - to allow higher load carrying capacity and to allow it to travel over rough terrain without getting hung up or damaging underbody components.
- Shorter - to give it the capability to approach inclines and drive over the crest of a hill without getting hung up or damaging underbody components. All other things held equal, a shorter wheelbase may make your vehicle quicker to respond to steering inputs than a vehicle with a longer wheelbase.
- Narrower - to provide greater maneuverability in tight spaces, particularly in off-road use.

As a result of the above dimensional differences, Sport utility vehicles and trucks often will have a higher center of gravity and a greater difference in center of gravity between the loaded and unloaded condition. These differences that make your vehicle so versatile also make it handle differently than an ordinary passenger car.

Wheels and Tires

TIRE CARE

Information About Uniform Tire Quality Grading



E142542

Tire Quality Grades apply to new pneumatic passenger car tires. The Quality grades can be found where applicable on the tire sidewall between tread shoulder and maximum section width. For example: **Treadwear 200 Traction AA Temperature A.**

These Tire Quality Grades are determined by standards that the United States Department of Transportation has set.

Tire Quality Grades apply to new pneumatic passenger car tires. They do not apply to deep tread, winter-type snow tires, space-saver or temporary use spare tires, light truck or LT type tires, tires with nominal rim diameters of 10 to 12 inches or limited production tires as defined in Title 49 Code of Federal Regulations Part 575.104 (c)(2).

U.S. Department of Transportation Tire quality grades:

The U.S. Department of Transportation requires Ford Motor Company to give you the following information about tire grades exactly as the government has written it.

Treadwear

The treadwear grade is a comparative rating based on the wear rate of the tire when tested under controlled conditions on a specified government test course. For example, a tire graded 150 would wear one and one-half ($1\frac{1}{2}$) times as well on the government course as a tire graded 100. The relative performance of tires depends upon the actual conditions of their use, however, and may depart significantly from the norm due to variations in driving habits, service practices, and differences in road characteristics and climate.

Traction AA A B C

WARNING



The traction grade assigned to this tire is based on straight-ahead braking traction tests, and does not include acceleration, cornering, hydroplaning or peak traction characteristics.

Wheels and Tires

The traction grades, from highest to lowest are AA, A, B, and C. The grades represent the tire's ability to stop on wet pavement as measured under controlled conditions on specified government test surfaces of asphalt and concrete. A tire marked C may have poor traction performance.

Temperature A B C

WARNING



The temperature grade for this tire is established for a tire that is properly inflated and not overloaded. Excessive speed, underinflation, or excessive loading, either separately or in combination, can cause heat buildup and possible tire failure.

The temperature grades are A (the highest), B and C, representing the tire's resistance to the generation of heat and its ability to dissipate heat when tested under controlled conditions on a specified indoor laboratory test wheel. Sustained high temperature can cause the material of the tire to degenerate and reduce tire life, and excessive temperature can lead to sudden tire failure. The grade C corresponds to a level of performance which all passenger car tires must meet under the

Federal Motor Vehicle Safety Standard No. 139. Grades B and A represent higher levels of performance on the laboratory test wheel than the minimum required by law.

Glossary of Tire Terminology

***Tire label:** A label showing the original equipment tire sizes, recommended inflation pressure and the maximum weight the vehicle can carry.

***Tire Identification Number (TIN):** A number on the sidewall of each tire providing information about the tire brand and manufacturing plant, tire size and date of manufacture. Also referred to as DOT code.

***Inflation pressure:** A measure of the amount of air in a tire.

***Standard load:** A class of P-metric or Metric tires designed to carry a maximum load at set pressure. For example: For P-Metric tires 35 psi (2.4 bar) or 36 psi (2.5 bar) depending on tire size and for Metric 36 psi (2.5 bar). Increasing the inflation pressure beyond this pressure will not increase the tire's load carrying capability.

***Extra load:** A class of P-metric or Metric tires designed to carry a heavier maximum load at 42 psi (2.9 bar). Increasing the inflation pressure beyond this pressure will not increase the tire's load carrying capability.

Wheels and Tires

***kPa:** Kilopascal, a metric unit of air pressure.

***PSI:** Pounds per square inch, a standard unit of air pressure.

***Cold tire pressure:** The tire pressure when the vehicle has been stationary and out of direct sunlight for an hour or more and prior to the vehicle being driven for 1 mile (1.6 kilometers).

***Recommended inflation pressure:** The cold inflation pressure found on the Safety Compliance Certification Label (affixed to either the door hinge pillar, door-latch post, or the door edge that meets the door-latch post, next to the driver's seating position), or Tire Label located on the B-pillar or the edge of the driver's door.

B-pillar: The structural member at the side of the vehicle behind the front door.

***Bead area of the tire:** Area of the tire next to the rim.

* **Sidewall of the tire:** Area between the bead area and the tread.

***Tread area of the tire:** Area of the perimeter of the tire that contacts the road when mounted on the vehicle.

***Rim:** The metal support (wheel) for a tire or a tire and tube assembly upon which the tire beads are seated.

Information Contained on the Tire Sidewall

Both United States and Canada Federal regulations require tire manufacturers to place standardized information on the sidewall of all tires. This information identifies and describes the fundamental characteristics of the tire and also provides a U.S. DOT Tire Identification Number for safety standard certification and in case of a recall.

Information on P Type Tires

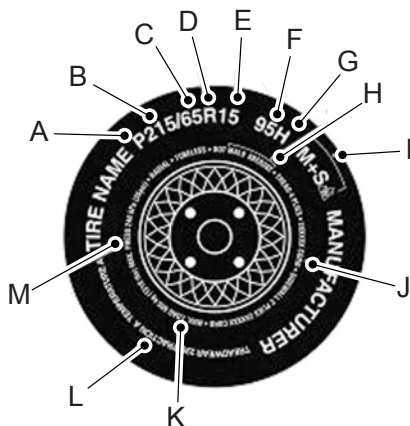

E142543

P215/65R15 95H is an example of a tire size, load index and speed rating. The definitions of these items are listed below. (Note that the tire size, load index and speed rating for your vehicle may be different from this example.)

Wheels and Tires

A. **P:** Indicates a tire, designated by the Tire and Rim Association, that may be used for service on cars, sport utility vehicles, minivans and light trucks. **Note:** If your tire size does not begin with a letter this may mean it is designated by either the European Tire and Rim Technical Organization or the Japan Tire Manufacturing Association.

B. **215:** Indicates the nominal width of the tire in millimeters from sidewall edge to sidewall edge. In general, the larger the number, the wider the tire.

C. **65:** Indicates the aspect ratio which gives the tire's ratio of height to width.

D. **R:** Indicates a radial type tire.

E. **15:** Indicates the wheel or rim diameter in inches. If you change your wheel size, you will have to purchase new tires to match the new wheel diameter.

F. **95:** Indicates the tire's load index. It is an index that relates to how much weight a tire can carry. You may find this information in your owner's manual. If not, contact a local tire dealer.

Note: *You may not find this information on all tires because it is not required by federal law.*

G. **H:** Indicates the tire's speed rating. The speed rating denotes the speed at which a tire is designed to be driven for extended periods of time under a standard condition of load and inflation pressure. The tires on your vehicle may operate at different conditions for load and inflation pressure. These speed ratings may need to be adjusted for the difference in conditions. The ratings range from 81 mph (130 km/h) to 186 mph (299 km/h). These ratings are listed in the following chart.

Note: *You may not find this information on all tires because it is not required by federal law.*

Letter rating	mph (km/h)
M	81 (130)
N	87 (140)
Q	99 (159)
R	106 (171)
S	112 (180)
T	118 (190)
U	124 (200)
H	130 (210)
V	149 (240)

Wheels and Tires

Letter rating	mph (km/h)
W	168 (270)
Y	186 (299)

Note: For tires with a maximum speed capability over 149 mph (240 km/h), tire manufacturers sometimes use the letters ZR. For those with a maximum speed capability over 186 mph (299 km/h), tire manufacturers always use the letters ZR.

H. U.S. DOT Tire Identification

Number: This begins with the letters DOT and indicates that the tire meets all federal standards. The next two numbers or letters are the plant code designating where it was manufactured, the next two are the tire size code and the last four numbers represent the week and year the tire was built. For example, the numbers 317 mean the 31st week of 1997. After 2000 the numbers go to four digits. For example, 2501 means the 25th week of 2001. The numbers in between are identification codes used for traceability. This information is used to contact customers if a tire defect requires a recall.

I. **M+S or M/S:** Mud and Snow, or

AT: All Terrain, or

AS: All Season.

J. Tire Ply Composition and Material Used:

Indicates the number of plies or the number of layers of rubber-coated fabric in the tire tread and sidewall. Tire manufacturers also must indicate the ply materials in the tire and the sidewall, which include steel, nylon, polyester, and others.

K. **Maximum Load:** Indicates the maximum load in kilograms and pounds that can be carried by the tire (affixed to either the door hinge pillar, door-latch post, or the door edge that meets the door-latch post, next to the driver's seating position), or Tire Label located on the B-pillar or the edge of the driver's door.

L. Treadwear, Traction and Temperature Grades:

***Treadwear:** The treadwear grade is a comparative rating based on the wear rate of the tire when tested under controlled conditions on a specified government test course. For example, a tire graded 150 would wear 1½ times as well on the government course as a tire graded 100.

Wheels and Tires

***Traction:** The traction grades, from highest to lowest are AA, A, B, and C. The grades represent the tire's ability to stop on wet pavement as measured under controlled conditions on specified government test surfaces of asphalt and concrete. A tire marked C may have poor traction performance.

***Temperature:** The temperature grades are A (the highest), B and C, representing the tire's resistance to the generation of heat and its ability to dissipate heat when tested under controlled conditions on a specified indoor laboratory test wheel.

M. Maximum Inflation Pressure:

Indicates the tire manufacturers' maximum permissible pressure or the pressure at which the maximum load can be carried by the tire. This pressure is normally higher than the vehicle manufacturer's recommended cold inflation pressure which can be found on the Safety Compliance Certification Label (affixed to either the door hinge pillar, door-latch post, or the door edge that meets the door-latch post, next to the driver's seating position), or Tire Label located on the B-pillar or the edge of the driver's door. The cold inflation pressure should never be set lower than the recommended pressure on the vehicle label.

The tire suppliers may have additional markings, notes or warnings such as standard load or radial tubeless.

Additional Information Contained on the Tire Sidewall for LT Type Tires

Note: *Tire Quality Grades do not apply to this type of tire.*

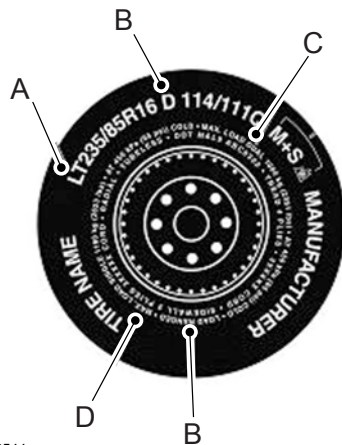

E142544

LT type tires have some additional information beyond those of P type tires. These differences are described below.

A. LT: Indicates a tire, designated by the Tire and Rim Association, that is intended for service on light trucks.

B. Load Range and Load Inflation Limits: Indicates the tire's load-carrying capabilities and its inflation limits.

Wheels and Tires

C. **Maximum Load Dual lb (kg) at psi (kPa) cold:**

Indicates the maximum load and tire pressure when the tire is used as a dual; defined as four tires on the rear axle (a total of six or more tires on the vehicle).

D. **Maximum Load Single lb (kg) at psi (kPa) cold:**

Indicates the maximum load and tire pressure when the tire is used as a single; defined as two tires (total) on the rear axle.

Information on T Type Tires

T145/80D16 is an example of a tire size.

Note: *The temporary tire size for your vehicle may be different from this example. Tire Quality Grades do not apply to this type of tire.*

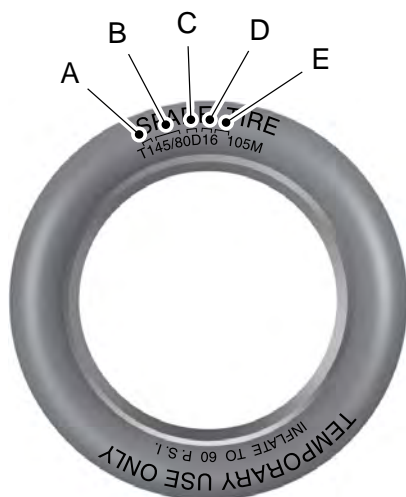

E142545

T type tires have some additional information beyond those of P type tires. These differences are described below:

A. **T:** Indicates a type of tire, designated by the Tire and Rim Association, that is intended for temporary service on cars, sport utility vehicles, minivans and light trucks.

B. **145:** Indicates the nominal width of the tire in millimeters from sidewall edge to sidewall edge. In general, the larger the number, the wider the tire.

Wheels and Tires

C. **80:** Indicates the aspect ratio which gives the tire's ratio of height to width. Numbers of 70 or lower indicate a short sidewall.

D. **D:** Indicates a diagonal type tire.

R: Indicates a radial type tire.

E. **16:** Indicates the wheel or rim diameter in inches. If you change your wheel size, you will have to purchase new tires to match the new wheel diameter.

Location of the Tire Label

You will find a Tire Label containing tire inflation pressure by tire size and other important information located on the B-Pillar or the edge of the driver's door. See **Load Carrying** (page 233).

Inflating Your Tires

Safe operation of your vehicle requires that your tires are properly inflated. Remember that a tire can lose up to half of its air pressure without appearing flat.

Every day before you drive, check your tires. If one looks lower than the others, use a tire gauge to check pressure of all tires and adjust if required.

At least once a month and before long trips, inspect each tire and check the tire pressure with a tire gauge (including spare, if equipped). Inflate all tires to the inflation pressure recommended by Ford Motor Company.

You are strongly urged to buy a reliable tire pressure gauge, as automatic service station gauges may be inaccurate. Ford recommends the use of a digital or dial-type tire pressure gauge rather than a stick-type tire pressure gauge.

Use the recommended cold inflation pressure for optimum tire performance and wear. Under-inflation or over-inflation may cause uneven treadwear patterns.

WARNING



Under-inflation is the most common cause of tire failures and may result in severe tire cracking, tread separation or blowout, with unexpected loss of vehicle control and increased risk of injury. Under-inflation increases sidewall flexing and rolling resistance, resulting in heat buildup and internal damage to the tire. It also may result in unnecessary tire stress, irregular wear, loss of vehicle control and accidents. A tire can lose up to half of its air pressure and not appear to be flat!

Always inflate your tires to the Ford recommended inflation pressure even if it is less than the maximum inflation pressure information found on the tire. The Ford recommended tire inflation pressure is found on the Safety Compliance Certification Label or

Wheels and Tires

Tire Label (affixed to either the door hinge pillar, door-latch post, or the door edge that meets the door-latch post, next to the driver's seating position), or Tire Label located on the B-pillar or the edge of the driver's door. Failure to follow the tire pressure recommendations can cause uneven treadwear patterns and adversely affect the way your vehicle handles.

Note: *Do not reduce tire pressure to change the ride characteristics of the vehicle. If you do not maintain the inflation pressure at the levels specified by Ford, your vehicle may experience a condition known as shimmy. Shimmy is a severe vibration and oscillation in the steering wheel after the vehicle travels over a bump or dip in the road that does not dampen out by itself. Shimmy may result from significant under-inflation of the tires, improper tires (load range, size, or type), or vehicle modifications such as lift-kits. In the event that your vehicle experiences shimmy, you should slowly reduce speed by either lifting off the accelerator pedal or lightly applying the brakes. The shimmy will cease as the vehicle speed decreases.*

Maximum Inflation Pressure is the tire manufacturer's maximum permissible pressure and the pressure at which the maximum load can be carried by the tire. This pressure is normally higher than

the manufacturer's recommended cold inflation pressure which can be found on the Safety Compliance Certification Label (affixed to either the door hinge pillar, door-latch post, or the door edge that meets the door-latch post, next to the driver's seating position), or Tire Label located on the B-pillar or the edge of the driver's door. The cold inflation pressure should never be set lower than the recommended pressure on the Safety Compliance Certification Label or Tire Label.

When weather temperature changes occur, tire inflation pressures also change. A 10°F (6°C) temperature drop can cause a corresponding drop of 1 psi (7 kPa) in inflation pressure. Check your tire pressures frequently and adjust them to the proper pressure which can be found on the Safety Compliance Certification Label or Tire Label.

To check the pressure in your tire(s):

1. Make sure the tires are cool, meaning they are not hot from driving even a mile.

Wheels and Tires

Note: *If you are checking tire pressure when the tire is hot, (for example, driven more than 1 mile [1.6 kilometers]), never bleed or reduce air pressure. The tires are hot from driving and it is normal for pressures to increase above recommended cold pressures. A hot tire at or below recommended cold inflation pressure could be significantly under-inflated.*

Note: *If you have to drive a distance to get air for your tire(s), check and record the tire pressure first and add the appropriate air pressure when you get to the pump. It is normal for tires to heat up and the air pressure inside to go up as you drive.*

2. Remove the cap from the valve on one tire, then firmly press the tire gauge onto the valve and measure the pressure.

3. Add enough air to reach the recommended air pressure.

Note: *If you overfill the tire, release air by pressing on the metal stem in the center of the valve. Then recheck the pressure with your tire gauge.*

4. Replace the valve cap.

5. Repeat this procedure for each tire, including the spare.

Note: *Some spare tires operate at a higher inflation pressure than the other tires. For T type mini-spare tires, see the Dissimilar spare wheel and tire assembly information for a description. Store and maintain at 60 psi (4.15 bar). For full-size and dissimilar spare tires, see the Dissimilar spare wheel and tire assembly information for a description. Store and maintain at the higher of the front and rear inflation pressure as shown on the Safety Compliance Certification Label or Tire Label.*

6. Visually inspect the tires to make sure there are no nails or other objects embedded that could poke a hole in the tire and cause an air leak.

7. Check the sidewalls to make sure there are no gouges, cuts or bulges.

Inspecting Your Tires and Wheel Valve Stems

Periodically inspect the tire treads for uneven or excessive wear and remove objects such as stones, nails or glass that may be wedged in the tread grooves. Check the tire and valve stems for holes, cracks, or cuts that may permit air leakage and repair or replace the tire and replace the valve stem. Inspect the tire sidewalls for cracking, cuts, bruises and other signs of damage or excessive wear. If internal damage to the tire is suspected, have the tire demounted and inspected in case

Wheels and Tires

it needs to be repaired or replaced. For your safety, tires that are damaged or show signs of excessive wear should not be used because they are more likely to blow out or fail.

Improper or inadequate vehicle maintenance can cause tires to wear abnormally. Inspect all your tires, including the spare, frequently, and replace them if one or more of the following conditions exist:

Tire Wear

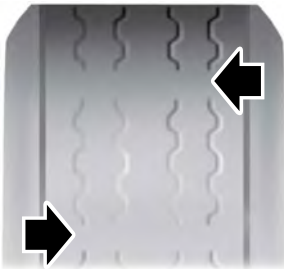

E142546

When the tread is worn down to one sixteenth of an inch (2 millimeters), tires must be replaced to help prevent your vehicle from skidding and hydroplaning. Built-in treadwear indicators, or wear bars, which look like narrow strips of smooth rubber across the tread will appear on the tire when the tread is worn down to one sixteenth of an inch (2 millimeters).

When the tire tread wears down to the same height as these wear bars, the tire is worn out and must be replaced.

Damage

Periodically inspect the tire treads and sidewalls for damage (such as bulges in the tread or sidewalls, cracks in the tread groove and separation in the tread or sidewall). If damage is observed or suspected have the tire inspected by a tire professional. Tires can be damaged during off-road use, so inspection after off-road use is also recommended.

Wheels and Tires

Age

WARNING

 Tires degrade over time depending on many factors such as weather, storage conditions, and conditions of use (load, speed, inflation pressure) the tires experience throughout their lives.

In general, tires should be replaced after six years regardless of tread wear. However, heat caused by hot climates or frequent high loading conditions can accelerate the aging process and may require tires to be replaced more frequently.

You should replace your spare tire when you replace the road tires or after six years due to aging even if it has not been used.

U.S. DOT Tire Identification Number

Both United States and Canada Federal regulations require tire manufacturers to place standardized information on the sidewall of all tires. This information identifies and describes the fundamental characteristics of the tire and also provides a U.S. DOT Tire Identification Number for safety standard certification and in case of a recall.

This begins with the letters DOT and indicates that the tire meets all federal standards. The next two numbers or letters are the plant code designating where it was manufactured, the next two are the tire size code and the last four numbers represent the week and year the tire was built. For example, the numbers 317 mean the 31st week of 1997. After 2000 the numbers go to four digits. For example, 2501 means the 25th week of 2001. The numbers in between are identification codes used for traceability. This information is used to contact customers if a tire defect requires a recall.

Tire Replacement Requirements

Your vehicle is equipped with tires designed to provide a safe ride and handling capability.

WARNINGS

 Only use replacement tires and wheels that are the same size, load index, speed rating and type (such as P-metric versus LT-metric or all-season versus all-terrain) as those originally provided by Ford. The recommended tire and wheel size may be found on either the Safety Compliance Certification Label or the Tire Label. If this information is not found on these labels then you should contact your authorized dealer as soon as possible. Use of any tire or wheel

Wheels and Tires

WARNINGS

not recommended by Ford can affect the safety and performance of your vehicle, which could result in an increased risk of loss of vehicle control, vehicle rollover, personal injury and death. Additionally the use of non-recommended tires and wheels could cause steering, suspension, axle, transfer case or power transfer unit failure. If you have questions regarding tire replacement, contact your authorized dealer as soon as possible.



To reduce the risk of serious injury, when mounting replacement tires and wheels, you should not exceed the maximum pressure indicated on the sidewall of the tire to set the beads without additional precautions listed below. If the beads do not seat at the maximum pressure indicated, re-lubricate and try again.

When inflating the tire for mounting pressures up to 20 psi (1.38 bar) greater than the maximum pressure on the tire sidewall, the following precautions must be taken to protect the person mounting the tire:

1. Make sure that you have the correct tire and wheel size.
2. Lubricate the tire bead and wheel bead seat area again.

WARNINGS

3. Stand at a minimum of 12 ft (3.6 m) away from the wheel and tire assembly.

4. Use both eye and ear protection.

For a mounting pressure more than 20 psi (1.38 bar) greater than the maximum pressure, a Ford dealer or other tire service professional should do the mounting.

Always inflate steel carcass tires with a remote air fill with the person inflating standing at a minimum of 12 ft (3.6 m) away from the wheel and tire assembly.

Important: Remember to replace the wheel valve stems when the road tires are replaced on your vehicle.

The two front tires or two rear tires should generally be replaced as a pair.

The tire pressure sensors mounted in the wheels are not designed to be used in aftermarket wheels.

The use of wheels or tires not recommended by Ford Motor Company may affect the operation of your tire pressure monitoring system.

Wheels and Tires

If the tire pressure monitoring system indicator is flashing, the system is malfunctioning. Your replacement tire might be incompatible with your tire pressure monitoring system, or some component of the system may be damaged.

Safety Practices

WARNINGS



If your vehicle is stuck in snow, mud, or sand, do not rapidly spin the tires; spinning the tires can tear the tire and cause an explosion. A tire can explode in as little as three to five seconds.



Do not spin the wheels at over 35 mph (56 km/h). The tires may fail and injure a passenger or bystander.

Driving habits have a great deal to do with your tire mileage and safety.

- *Observe posted speed limits
- *Avoid fast starts, stops and turns
- *Avoid potholes and objects on the road
- *Do not run over curbs or hit the tire against a curb when parking

Highway Hazards

No matter how carefully you drive there's always the possibility that you may eventually have a flat tire on the highway. Drive slowly to the closest safe area out of traffic. This may further damage the flat tire, but your safety is more important.

If you feel a sudden vibration or ride disturbance while driving, or you suspect your tire or vehicle has been damaged, immediately reduce your speed. Drive with caution until you can safely pull off the road. Stop and inspect the tires for damage. If a tire is under-inflated or damaged, deflate it, remove wheel and replace it with your spare tire and wheel. If you cannot detect a cause, have the vehicle towed to the nearest repair facility or tire dealer to have the vehicle inspected.

Tire and Wheel Alignment

A bad jolt from hitting a curb or pothole can cause the front end of your vehicle to become misaligned or cause damage to your tires. If your vehicle seems to pull to one side when you're driving, the wheels may be out of alignment. Have an authorized dealer check the wheel alignment periodically.

Wheels and Tires

Wheel misalignment in the front or the rear can cause uneven and rapid treadwear of your tires and should be corrected by an authorized dealer. Front-wheel drive vehicles and those with an independent rear suspension may require alignment of all four wheels.

The tires should also be balanced periodically. An unbalanced tire and wheel assembly may result in irregular tire wear.

Tire Rotation

WARNING

 If the tire label shows different tire pressures for the front and rear tires and the vehicle is equipped with a tire pressure monitoring system, then the settings for the system sensors need to be updated. Always perform the system reset procedure after tire rotation. If the system is not reset, it may not provide a low tire pressure warning when necessary. See the tire pressure monitoring system reset procedure in this chapter.

Note: *If your tires show uneven wear ask an authorized dealer to check for and correct any wheel misalignment, tire imbalance or mechanical problem involved before tire rotation.*

Note: *Your vehicle may be equipped with a dissimilar spare wheel and tire assembly. A dissimilar spare wheel and tire assembly is defined as a spare wheel and tire assembly that is different in brand, size or appearance from the road tires and wheels. If you have a dissimilar spare wheel and tire assembly it is intended for temporary use only and should not be used in a tire rotation.*

Note: *After having your tires rotated, inflation pressure must be checked and adjusted to the vehicle requirements.*

Rotating your tires at the recommended interval (as indicated in the Scheduled Maintenance chapter) will help your tires wear more evenly, providing better tire performance and longer tire life.

Rear-wheel drive vehicles and four-wheel drive vehicles (front tires at left of diagram)

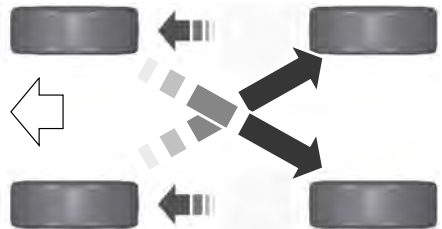

E142548

Wheels and Tires

Sometimes irregular tire wear can be corrected by rotating the tires.

USING SNOW CHAINS

WARNING



Snow tires must be the same size, load index, speed rating as those originally provided by Ford. Use of any tire or wheel not recommended by Ford can affect the safety and performance of your vehicle, which could result in an increased risk of loss of vehicle control, vehicle rollover, personal injury and death. Additionally, the use of non-recommended tires and wheels could cause steering, suspension, axle, transfer case or power transfer unit failure.

Note: *The suspension insulation and bumpers will help prevent vehicle damage. Do not remove these components from your vehicle when using snow tires and chains.*

The tires on your vehicle have all-weather treads to provide traction in rain and snow. However, in some climates, you may need to use snow tires and cables. If you need to use cables, it is recommended that steel wheels (of the same size and specifications) be used, as cables may chip aluminum wheels.

Follow these guidelines when using snow tires and chains:

- If possible, avoid fully loading your vehicle.
- Use only cable type chains or chains offered by Ford/Lincoln as an accessory or equivalent. Other conventional link type chains may contact and cause damage to the vehicle's wheel house and/or body.
- Do not install chains on the front tires as this may interfere with suspension components.

- Only certain snow cables or chains have been approved by Ford/Lincoln as safe for use on your vehicle with the following tires: 245/70R17, LT245/70R17, 265/70R17 and 265/60R18.
- You should install snow cables or chains that have been rated as SAE Class S.
- Install chains securely, verifying that the chains do not touch any wiring, brake lines, or fuel lines.
- Do not exceed 30 mph (50 km/h) or less if recommended by the chain manufacturer while using snow chains.
- Drive cautiously. If you hear the chains rub or bang against your vehicle, stop and retighten the chains. If this does not work, remove the chains to prevent damage to your vehicle.
- Remove the tire chains when they are no longer needed. Do not use tire chains on dry roads.
- Purchase chains or cables from a manufacturer that clearly labels body to tire dimension restrictions. The snow chains or cables must be mounted in pairs on the rear tires only.

If you have any questions regarding snow chains or cables, please contact your Ford/Lincoln authorized dealer.

Wheels and Tires

TIRE PRESSURE MONITORING SYSTEM

WARNING



The tire pressure monitoring system is not a substitute for manually checking the tire pressure. The tire pressure should be checked periodically (at least monthly) using a tire pressure gauge. Failure to properly maintain your tire pressure could increase the risk of tire failure, loss of control, vehicle rollover and personal injury.



Each tire, including the spare (if provided), should be checked monthly when cold and inflated to the inflation pressure recommended by the vehicle manufacturer on the vehicle placard or tire inflation pressure label. (If your vehicle has tires of a different size than the size indicated on the vehicle placard or tire inflation pressure label, you should determine the proper tire inflation pressure for those tires.)

As an added safety feature, your vehicle has been equipped with a Tire Pressure Monitoring System (TPMS) that illuminates a low tire pressure telltale when one or more of your tires is significantly under-inflated. Accordingly, when the low tire pressure telltale illuminates, you should stop and check your tires as soon as possible, and inflate them to the proper pressure. Driving on a significantly under-inflated tire causes the tire to overheat and can lead to tire failure. Under-inflation also reduces fuel efficiency and tire tread life, and may affect the vehicle's handling and stopping ability.

Please note that the TPMS is not a substitute for proper tire maintenance, and it is the driver's responsibility to maintain correct tire pressure, even if under-inflation has not reached the level to trigger illumination of the TPMS low tire pressure telltale.

Your vehicle has also been equipped with a TPMS malfunction indicator to indicate when the system is not operating properly. The TPMS malfunction indicator is combined with the low tire pressure telltale. When the system detects a malfunction, the telltale will flash for approximately one minute and then remain continuously illuminated. This sequence will continue upon subsequent vehicle start-ups as long as the malfunction exists.

When the malfunction indicator is illuminated, the system may not be able to detect or signal low tire pressure as intended. TPMS malfunctions may occur for a variety of reasons, including the installation of replacement or alternate tires or wheels on the vehicle that prevent the TPMS from functioning properly. Always check the TPMS malfunction telltale after replacing one or more tires or wheels on your vehicle to ensure that the replacement or alternate tires and wheels allow the TPMS to continue to function properly.

The tire pressure monitoring system complies with part 15 of the FCC rules and with RSS-210 of Industry Canada. Operation is subject to the following two conditions: (1) This device may not cause harmful interference, and (2) This device must accept any interference received, including interference that may cause undesired operation.

Wheels and Tires

This device complies with part 15 of the FCC Rules and with Licence exempt RSS Standards of Industry Canada. Operation is subject to the following two conditions:

- This device may not cause harmful interference.
- This device must accept any interference received, including interference that may cause undesired operation.

Changing Tires With a Tire Pressure Monitoring System



E142549

Note: Each road tire is equipped with a tire pressure sensor located inside the wheel and tire assembly cavity. The pressure sensor is attached to the valve stem. The pressure sensor is covered by the tire and is not visible unless the tire is removed. Take care when changing the tire to avoid damaging the sensor.

You should always have your tires serviced by an authorized dealer.

Check the tire pressure periodically (at least monthly) using an accurate tire gauge. See *Inflating Your Tires* in this chapter.

Understanding Your Tire Pressure Monitoring System

The tire pressure monitoring system measures pressure in your four road tires and sends the tire pressure readings to your vehicle. The low tire pressure warning light will turn on if the tire pressure is significantly low. Once the light is illuminated, your tires are under-inflated and need to be inflated to the manufacturer's recommended tire pressure. Even if the light turns on and a short time later turns off, your tire pressure still needs to be checked.

When Your Temporary Spare Tire is Installed

When one of your road tires needs to be replaced with the temporary spare, the system will continue to identify an issue to remind you that the damaged road wheel and tire assembly needs to be repaired and put back on your vehicle.

To restore the full function of the tire pressure monitoring system, have the damaged road wheel and tire assembly repaired and remounted on your vehicle.

When You Believe Your System is Not Operating Properly

The main function of the tire pressure monitoring system is to warn you when your tires need air. It can also warn you in the event the system is no longer capable of functioning as intended. See the following chart for information concerning your tire pressure monitoring system:

Wheels and Tires

Low tire pressure warning light	Possible cause	Customer action required
Solid warning light	Tire(s) under-inflated	Make sure tires are at the proper pressure. See Inflating your tires in this chapter. After inflating your tires to the manufacturer's recommended pressure as shown on the Tire Label (located on the edge of driver's door or the B-Pillar), the vehicle must be driven for at least two minutes over 20 mph (32 km/h) before the light turns off.
	Spare tire in use	Repair the damaged road wheel and tire assembly and reinstall it on the vehicle to restore system function. For a description on how the system functions, see When your temporary spare tire is installed in this section.
	Tire pressure monitoring system malfunction	If the tires are properly inflated and the spare tire is not in use but the light remains on, contact your authorized dealer as soon as possible.
	Tire rotation without sensor training	On vehicles with different front and rear tire pressures, the system must be retrained following every tire rotation. See Tire Care (page 331).
Flashing warning light	Spare tire in use	Repair the damaged road wheel and tire assembly and reinstall it on the vehicle to restore system function. For a description on how the system functions, see When your temporary spare tire is installed in this section.
	Tire pressure monitoring system malfunction	If the tires are properly inflated and the spare tire is not in use but the light remains on, contact your authorized dealer as soon as possible.

Wheels and Tires

When Inflating Your Tires

When putting air into your tires (such as at a gas station or in your garage), the tire pressure monitoring system may not respond immediately to the air added to your tires.

It may take up to two minutes of driving over 20 mph (32 km/h) for the light to turn off after you have filled your tires to the recommended inflation pressure.

How Temperature Affects Your Tire Pressure

The tire pressure monitoring system monitors tire pressure in each pneumatic tire. While driving in a normal manner, a typical passenger tire inflation pressure may increase about 2 to 4 psi (14 to 28 kPa) from a cold start situation. If the vehicle is stationary overnight with the outside temperature significantly lower than the daytime temperature, the tire pressure may decrease about 3 psi (21 kPa) for a drop of 30°F (17°C) in ambient temperature. This lower pressure value may be detected by the tire pressure monitoring system as being significantly lower than the recommended inflation pressure and activate the system warning light for low tire pressure.

If the low tire pressure warning light is on, visually check each tire to verify that no tire is flat. If one or more tires are flat, repair as necessary. Check the air pressure in the road tires. If any tire is under-inflated, carefully drive the vehicle to the nearest location where air can be added to the tires. Inflate all the tires to the recommended inflation pressure.

Tire Pressure Monitoring System Reset Procedure

WARNING



To determine the required pressure(s) for your vehicle, see the Safety Compliance Certification Label (affixed to either the door hinge pillar, door-latch post, or the door edge that meets the door-latch post, next to the driver's seating position), or Tire Label located on the B-Pillar or the edge of the driver's door.

Note: *You need to perform the tire pressure monitoring system reset procedure after each tire rotation on vehicles that require different recommended tire pressures in the front tires as compared to the rear tires.*

Overview

To provide the vehicle's load carrying capability, some vehicles require different recommended tire pressures in the front tires as compared to the rear tires. The tire pressure monitoring system equipped on these vehicles is designed to illuminate the low tire pressure warning light at two different pressures; one for the front tires and one for the rear tires.

Since tires need to be rotated to provide consistent performance and maximum tire life, the tire pressure monitoring system needs to know when the tires are rotated to determine which set of tires are on the front and which are on the rear. With this information, the system can detect and properly warn of low tire pressures.

System reset tips:

Wheels and Tires

- To reduce the chances of interference from another vehicle, perform the system reset procedure at least three feet (one meter) away from another Ford Motor Company vehicle undergoing the system reset procedure at the same time.
- Do not wait more than two minutes between resetting each tire sensor or the system will time-out and the entire procedure will have to be repeated on all four wheels.
- A double horn will sound indicating the need to repeat the procedure.

Performing the System Reset Procedure

Read the entire procedure before attempting.

1. Drive the vehicle above 20 mph (32 km/h) for at least two minutes, then park in a safe location where you can easily get to all four tires and have access to an air pump.
2. Place the ignition in the off position and keep the key in the ignition.
3. Cycle the ignition to the on position with the engine off.
4. Turn the hazard flashers on then off three times. You must accomplish this within 10 seconds. If the reset mode has been entered successfully, the horn will sound once, the system indicator will flash and a message is shown in the information display. If this does not occur, please try again starting at Step 2. If after repeated attempts to enter the reset mode, the horn does not sound, the system indicator does not flash and no message is shown in the information display, seek service from your authorized dealer.
5. Train the tire pressure monitoring system sensors in the tires using the following system reset sequence starting with the left front tire in the following clockwise order: Left front (driver's side front tire), Right front (passenger's side front tire), Right rear (passenger's side rear tire), Left rear (driver's side rear tire).
6. Remove the valve cap from the valve stem on the left front tire. Decrease the air pressure until the horn sounds.
Note: The single horn chirp confirms that the sensor identification code has been learned by the module for this position. If a double horn is heard, the reset procedure was unsuccessful, and you must repeat it.
7. Remove the valve cap from the valve stem on the right front tire. Decrease the air pressure until the horn sounds.
8. Remove the valve cap from the valve stem on the right rear tire. Decrease the air pressure until the horn sounds.
9. Remove the valve cap from the valve stem on the left rear tire. Decrease the air pressure until the horn sounds. Training is complete after the horn sounds for the last tire trained (driver's side rear tire), the system indicator stops flashing, and a message is shown in the information display.
10. Turn the ignition off. If two short horn beeps are heard, the reset procedure was unsuccessful and you must repeat it. If after repeating the procedure and two short beeps are heard when the ignition is turned to off, seek assistance from your authorized dealer.

Wheels and Tires

11. Set all four tires to the recommended air pressure as indicated on the Safety Compliance Certification Label (affixed to either the door hinge pillar, door-latch post, or the door edge that meets the door-latch post, next to the driver's seating position) or Tire Label located on the B-Pillar or the edge of the driver's door.

Have a flat serviced by an authorized dealer in order to prevent damage to the system sensors. See **Tire Pressure Monitoring System** (page 347). Replace the spare tire with a road tire as soon as possible. During repairing or replacing of the flat tire, have the authorized dealer inspect the system sensor for damage.

Dissimilar Spare Wheel and Tire Assembly Information

CHANGING A ROAD WHEEL

WARNINGS



The use of tire sealant may damage your tire pressure monitoring system and should only be used in roadside emergencies. If you must use a sealant, the Ford Tire Mobility Kit sealant should be used. The tire pressure monitoring system sensor and valve stem on the wheel must be replaced by an authorized dealer after use of the sealant.



If the tire pressure monitor sensor becomes damaged, it will no longer function. See **Tire Pressure Monitoring System** (page 347).

Note: *The tire pressure monitoring system indicator light will illuminate when the spare tire is in use. To restore the full function of the monitoring system, all road wheels equipped with tire pressure monitoring sensors must be mounted on this vehicle.*

If you get a flat tire while driving, do not apply the brake heavily. Instead, gradually decrease your speed. Hold the steering wheel firmly and slowly move to a safe place on the side of the road.

WARNING



Failure to follow these guidelines could result in an increased risk of loss of vehicle control, injury or death.

If you have a dissimilar spare wheel and tire, then it is intended for temporary use only. This means that if you need to use it, you should replace it as soon as possible with a road wheel and tire assembly that is the same size and type as the road tires and wheels that were originally provided by Ford. If the dissimilar spare tire or wheel is damaged, it should be replaced rather than repaired.

A dissimilar spare wheel and tire assembly is defined as a spare wheel and tire assembly that is different in brand, size or appearance from the road tires and wheels and can be one of three types:

1. **T-type mini-spare:** This spare tire begins with the letter T for tire size and may have Temporary Use Only molded in the sidewall.
2. **Full-size dissimilar spare with label on wheel:** This spare tire has a label on the wheel that states: THIS WHEEL AND TIRE ASSEMBLY FOR TEMPORARY USE ONLY

Wheels and Tires

When driving with one of the dissimilar spare tires listed above, do not:

- Exceed 50 mph (80 km/h).
- Load the vehicle beyond maximum vehicle load rating listed on the Safety Compliance Label.
- Tow a trailer.
- Use snow chains on the end of the vehicle with the dissimilar spare tire.
- Use more than one dissimilar spare tire at a time.
- Use commercial car washing equipment.
- Try to repair the dissimilar spare tire.

Use of one of the dissimilar spare tires listed above at any one wheel location can lead to impairment of the following:

- Handling, stability and braking performance.
- Comfort and noise.
- Ground clearance and parking at curbs.
- Winter weather driving capability.
- Wet weather driving capability.
- All-wheel driving capability.

3. Full-size dissimilar spare without label on wheel

When driving with the full-size dissimilar spare wheel and tire assembly, do not:

- Exceed 70 mph (113 km/h).
- Use more than one dissimilar spare wheel and tire assembly at a time.

- Use commercial car washing equipment.
- Use snow chains on the end of the vehicle with the dissimilar spare wheel and tire assembly.

The usage of a full-size dissimilar spare wheel and tire assembly can lead to impairment of the following:

- Handling, stability and braking performance.
- Comfort and noise.
- Ground clearance and parking at curbs.
- Winter weather driving capability.
- Wet weather driving capability.
- All-wheel driving capability.

When driving with the full-size dissimilar spare wheel and tire assembly additional caution should be given to:

- Towing a trailer.
- Driving vehicles equipped with a camper body.
- Driving vehicles with a load on the cargo rack.

Drive cautiously when using a full-size dissimilar spare wheel and tire assembly and seek service as soon as possible.

Location of the Spare Tire and Tools

The spare tire is located under the vehicle, just forward of the rear bumper. The jack, jack handle and lug wrench are located in the following locations:

Body style	Location
Regular Cab	Attached to the floor behind the passenger seat (for easier access, move the passenger seat forward)
Super Cab and Crew Cab	Attached behind the rear seat on the passenger side

Wheels and Tires

Tire Change Procedure

WARNINGS



When one of the front wheels is off the ground, the transmission alone will not prevent the vehicle from moving or slipping off the jack.



To help prevent the vehicle from moving when you change a tire, be sure to place the transmission in park (P), set the parking brake and block (in both directions) the wheel that is diagonally opposite (other side and end of the vehicle) to the tire being changed.



Never get underneath a vehicle that is supported only by a jack. If the vehicle slips off the jack, you or someone else could be seriously injured.



Do not attempt to change a tire on the side of the vehicle close to moving traffic. Pull far enough off the road to avoid the danger of being hit when operating the jack or changing the wheel.



Always use the jack provided as original equipment with your vehicle. If using a jack other than the one provided as original equipment with your vehicle, make sure the jack capacity is adequate for the vehicle weight, including any vehicle cargo or modifications.

WARNINGS



Disable the power running boards before jacking, lifting, or placing any object under the vehicle. Never place your hand between the power running board and the vehicle as extended power running boards will retract when the doors are closed. Failure to follow these instructions may result in personal injury.



Failure to follow these instructions when using the spare tire carrier could cause loss of the wheel and tire and lead to personal injury: Only use the spare tire carrier to stow the tire and wheel combination specified on the Tire Label or Safety Compliance Certification Label on the B-Pillar or the edge of the driver door. Other tire and wheel combinations could cause the carrier to fail if it does not fit securely or is too heavy. Do not use impact tools or power tools operating over 200 RPM, which may cause winch malfunction and prevent a secure fit. Override the winch at least three times (there will be an audible click each time) to ensure a tight secure fit of the wheel and tire.

Note: *Passengers should not remain in the vehicle when the vehicle is being jacked.*

Park on a level surface, activate the hazard flashers and set the parking brake. Then, place the transmission in park (P) and turn the engine off.

Wheels and Tires

Removing the Jack and Tools

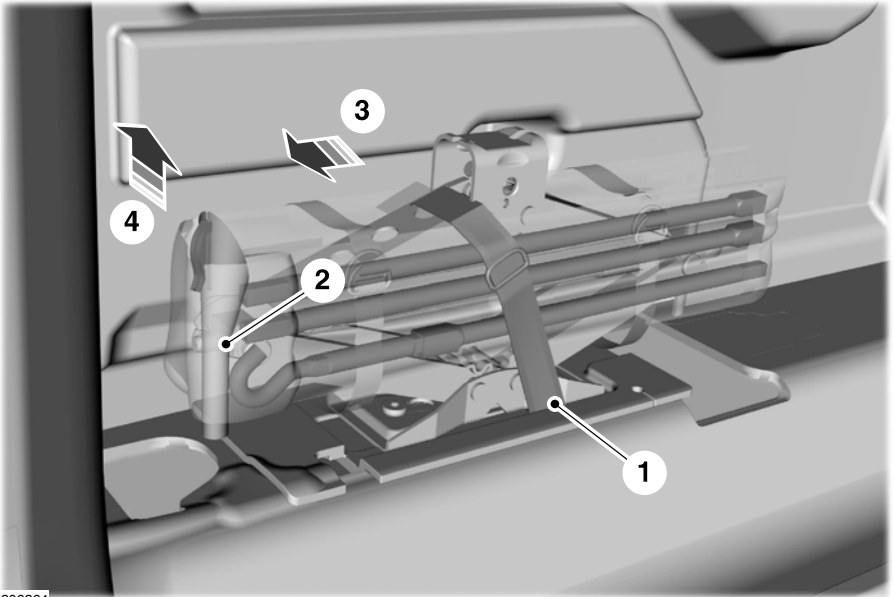

E206264

1. From the passenger side of the vehicle, unstrap the large center strap securing the jacking kit to the floor posts.
2. Remove the fuel funnel.
3. With slight downward pressure, slide the jacking kit outward, toward the passenger side of the vehicle.
4. Lift the jacking kit off the floor posts.

Removing the Spare Tire



E188735

Wheels and Tires

1. Use your key to remove the lock cylinder from the access hole of the bumper to allow access to the guide tube. Assemble the jack handle as shown in the illustration.

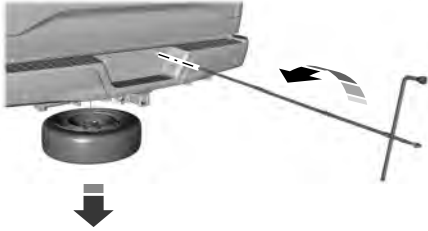

E184020

2. Fully insert the jack handle through the bumper hole and into the guide tube through the access hole in the rear bumper.
3. Turn the handle counterclockwise until the tire is lowered to the ground, the tire can be slid rearward and the cable is slightly slack.
4. Remove the retainer from the center of the wheel.

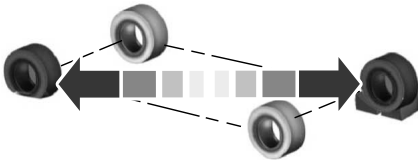

E175447

5. Block both the front and rear of the wheel diagonally opposite the flat tire. For example, if the left front tire is flat, block the right rear wheel.

6. Obtain the spare tire and jack from their storage locations.
7. Loosen each wheel lug nut on the affected flat tire one-half turn counterclockwise, but do not remove them.

Jacking the Vehicle

Front Jacking Points



E183709

Note: Use the frame rail as the jacking location point, not the control arm. The frame rail is marked with an arrow.

Wheels and Tires

Rear Jacking Points

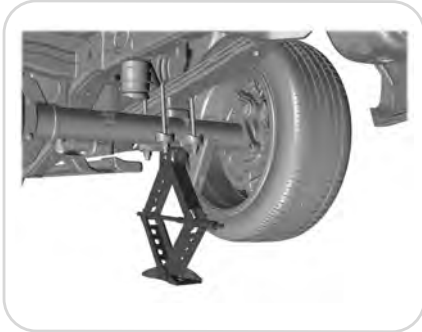
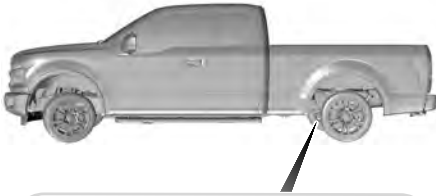

E183403

Note: Jack at the specified locations to avoid damage to the vehicle.

1. Place the jack at the jacking point next to the tire you are changing. Turn the jack handle clockwise until the wheel is completely off the ground.
2. Remove the lug nuts with the lug wrench.
3. Replace the flat tire with the spare tire, making sure the valve stem is facing outward. Reinstall the lug nuts until the wheel is snug against the hub. Do not fully tighten the lug nuts until the wheel has been lowered.
4. Lower the wheel by turning the jack handle counterclockwise.

5. Remove the jack and fully tighten the lug nuts in the order shown. See **Technical Specifications** (page 360).
6. Stow the flat tire. See the Stowing the Flat or Spare Tire.
7. Stow the jack and lug wrench. Make sure the jack is fastened securely before you drive. See Stowing the Jack and Tools.
8. Unblock the wheels.



E166719

Stowing the Flat or Spare Tire

Note: Failure to follow the spare tire stowage instructions may result in failure of the cable or loss of the spare tire.

1. Lay the tire on the ground with the valve stem facing up.
2. Slide the wheel partially under the vehicle and install the retainer through the wheel center. Pull on the cable to align the components at the end of the cable.
3. Turn the jack handle clockwise until the tire is raised to its stowed position underneath the vehicle. The effort to turn the jack handle increases significantly and the spare tire carrier ratchets or slips when the tire is raised to the maximum tightness. Tighten to

Wheels and Tires

the best of your ability, to the point where the ratchet or slip occurs, if possible. The spare tire carrier will not allow you to overtighten. If the spare tire carrier ratchets or slips with little effort, contact your authorized dealer.

4. Check that the tire lies flat against the frame and is properly tightened. Try to push or pull, then turn the tire to be sure it will not move. Loosen and retighten, if necessary. Failure to properly stow the spare tire may result in failure of the winch cable and loss of the tire.
5. Repeat this tightness check procedure when servicing the spare tire pressure (every six months, as per your scheduled maintenance information), or at any time that the spare tire is disturbed through service of other components.
6. If removed, install the spare tire lock into the bumper drive tube with the spare tire lock key and jack handle.

Stowing the Jack and Tools

1. Place the jacking tools in the tool bag and secure the velcro flaps.

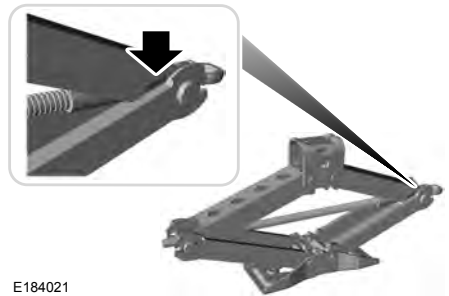

E184021

2. Adjust the jack up or down by rotating the lead screw located on the end of the jack. The stowage markings should line up with the bottom channel.
3. Place the jack in the vehicle so that the lead screw adjustment is facing the driver side of the vehicle.
4. Place the tool bag on top of the jack. The jack base fits within the opening of the jack tool bag.
5. Attach the flap around the lead screw and secure the flap to the velcro.
6. Secure the two D-ring straps tightly.
7. Secure the velcro straps through the hole of the lead screw tightly.
8. Place the jack so the lug wrench faces the rear of the vehicle. Position the jack base so the key hole slots align with the jacking posts.

Wheels and Tires

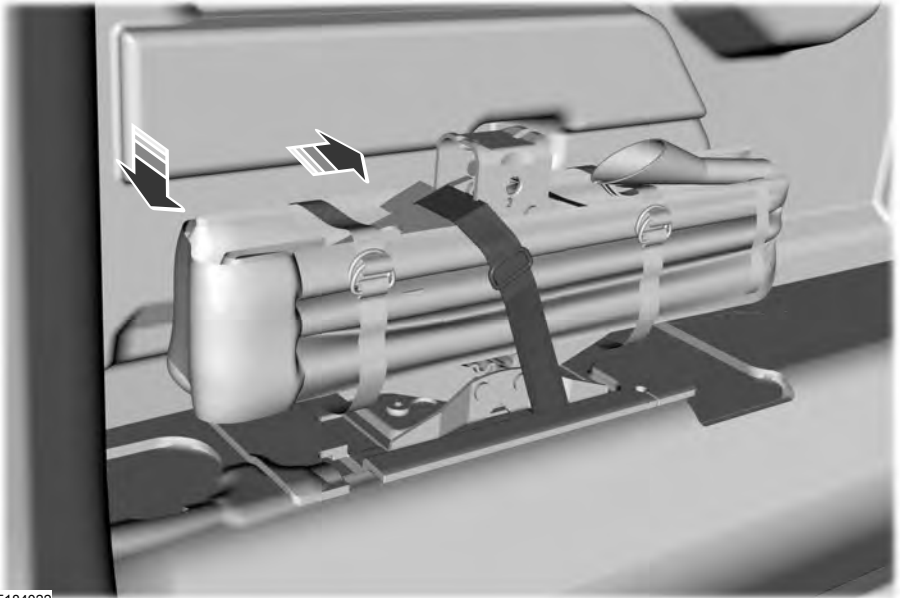

E184022

9. With slight downward pressure, slide the jack and tool assembly toward the driver side of the vehicle until it stops.
10. Secure the large strap.
11. Clip the fuel funnel back in place.

Wheels and Tires

TECHNICAL SPECIFICATIONS

Wheel Lug Nut Torque Specifications

WARNING



When a wheel is installed, always remove any corrosion, dirt or foreign materials present on the mounting surfaces of the wheel or the surface of the wheel hub, brake drum or brake disc that contacts the wheel. Make sure that any fasteners that attach the rotor to the hub are secured so they do not interfere with the mounting surfaces of the wheel. Installing wheels without correct metal-to-metal contact at the wheel mounting surfaces can cause the wheel nuts to loosen and the wheel to come off while your vehicle is in motion, resulting in loss of control.

Bolt size	lb.ft (Nm)
M14 x 1.5	150 lb.ft (204 Nm)

*Torque specifications are for nut and bolt threads free of dirt and rust. Use only Ford recommended replacement fasteners.

Retighten the lug nuts to the specified torque within 100 miles (160 kilometers) after any wheel disturbance (such as tire rotation, changing a flat tire, wheel removal).



E145950

A Wheel pilot bore

Inspect the wheel pilot hole and mounting surface prior to installation. Remove any visible corrosion or loose particles.

Capacities and Specifications

ENGINE SPECIFICATIONS

Engine	2.7L EcoBoost	3.5L V6 EcoBoost	3.5L V6 TiVCT	5.0L V8
Cubic inches	164	214	214	302
Required fuel	Minimum 87 octane	Minimum 87 octane	Minimum 87 octane or E85	Minimum 87 octane or E85
Firing order	1-4-2-5-3-6	1-4-2-5-3-6	1-4-2-5-3-6	1-3-7-2-6-5-4-8
Ignition system	Coil on plug	Coil on plug	Coil on plug	Coil on plug
Spark plug gap	.028-.031 (0.7 - 0.8 mm)	.030-.033 in. (0.75 - 0.85 mm)	.049-.053 in. (1.25 - 1.35 mm)	.049-.053 in. (1.25 - 1.35 mm)
Compression ratio	10.0:1	10.0:1	10.8:1	10.5:1

Drivebelt Routing

2.7L EcoBoost Engines with A/C



E176088

3.5L V6 Engines with A/C

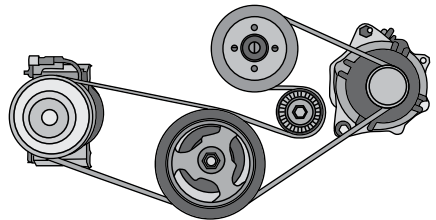

E167467

5.0L V8 Engines with A/C

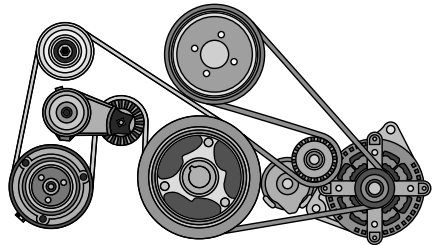

E167465

Capacities and Specifications

MOTORCRAFT PARTS

Component	2.7L EcoBoost	3.5L V6 EcoBoost	3.5L V6 TiVCT	5.0L V8
Air filter element	FA-1883	FA-1883	FA-1883	FA-1883
Oil filter	FL-2062	FL-500-S	FL-500-S	FL-500-S
Battery	BAGM-48H6-760	BXT-48H6-610	BXT-48H6-610	BXT-48H6-610
	BAGM-94RH7-800 (King Ranch, Lariat and Premium)	BXT-94RH7-730 (King Ranch, Lariat and Premium)	BXT-94RH7-730 (King Ranch, Lariat and Premium)	BXT-94RH7-730 (King Ranch, Lariat and Premium)
Spark plugs	SP-542	SP-534	SP-520	SP-519
Windshield wiper blade	WW-2242			
Cabin air filter	FP-79			

We recommend Motorcraft replacement parts available at your Ford dealer or at fordparts.com for scheduled maintenance. These parts meet or exceed Ford Motor Company's specifications and are engineered for your vehicle. Use of other parts may impact vehicle performance, emissions and durability. Your warranty may be void for any damage related to use of other parts.

If a Motorcraft oil filter is not available, use an oil filter that meets industry performance specification SAE/USCAR-36.

For spark plug replacement, contact an authorized dealer. Replace the spark plugs at the appropriate intervals. See **Scheduled Maintenance** (page 501).

VEHICLE IDENTIFICATION NUMBER

The vehicle identification number is located on the left-hand side of the instrument panel.

Capacities and Specifications

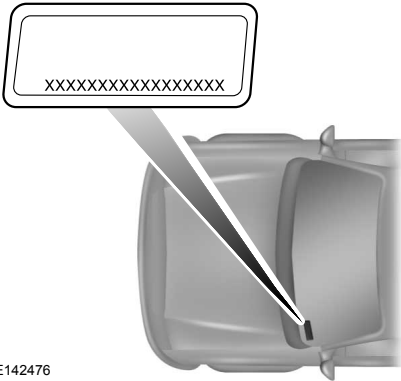

E142476

Please note that in the graphic, XXXX is representative of your vehicle identification number.

The Vehicle Identification Number contains the following information:

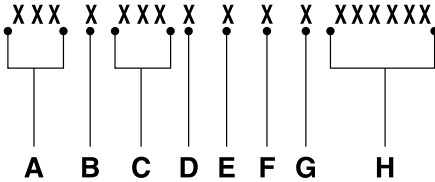

E142477

- A World manufacturer identifier
- B Brake system, Gross Vehicle Weight Rating, Restraint Devices and their locations
- C Make, vehicle line, series, body type
- D Engine type
- E Check digit

- F Model year
- G Assembly plant
- H Production sequence number

VEHICLE CERTIFICATION LABEL

MFD. BY FORD MOTOR CO.

DATE: XX/XX	GVWR: XXXX KG (XXXX LB)
FRONT GAWR: XXXX KG (XXXX LB)	REAR GAWR: XXXX KG (XXXX LB)
XXXXXXXXXXXXXXXXXX	WITH TIRES XXXXXXXXXXXXXXXX
XXXXXXXX	RIMS XXXXXX
AT XXXX kPa/ XXX PSI COLD	AT XXXX kPa/ XXX PSI COLD

THIS VEHICLE CONFORMS TO ALL APPLICABLE FEDERAL MOTOR VEHICLE SAFETY AND THEFT PREVENTION STANDARDS IN EFFECT ON THE DATE OF MANUFACTURE SHOWN ABOVE.

VIN: XXXXXXXXXXXXXXXXX XXXXX
XXXXX

TYPE: XXXX

EXT PNT: XX	XXXXXX	RC: XX	DSO: XXXX
WB	INT TR	TP/PS	I R
XXX	XX	XXX	X
		XX	X
		XXXX	XXXX
		XXXX	XXXX-XXXXXXXX-XX

E167469

The National Highway Traffic Safety Administration Regulations require that a Safety Compliance Certification Label be affixed to a vehicle and prescribe where the Safety Compliance Certification Label may be located. The Safety Compliance Certification Label shall be affixed to either the door hinge pillar, the door latch post, or the edge of the door near the door latch, next to the driver's seating position.

Capacities and Specifications

TRANSMISSION CODE DESIGNATION

The transmission code is on the Safety Compliance Certification Label. The following table shows the transmission code along with the transmission description.

MFD. BY FORD MOTOR CO.

DATE: XX/XX GVWR: XXXX KG (XXXX LB)
 FRONT GAWR: WITH REAR GAWR:
 XXXX KG (XXXX LB) WITH XXXX KG (XXXX LB) WITH
 XXXXXXXXXXXXXXXX TIRES XXXXXXXXXXXXXXXX TIRES
 XXXXXXXX RIMS XXXXXXXX RIMS
 AT XXXX kPa/ XXX PSI COLD AT XXXX kPa/ XXX PSI COLD

THIS VEHICLE CONFORMS TO ALL APPLICABLE FEDERAL MOTOR VEHICLE SAFETY AND THEFT PREVENTION STANDARDS IN EFFECT ON THE DATE OF MANUFACTURE SHOWN ABOVE.

VIN: XXXXXXXXXXXXXXXX XXXXX
 TYPE: XXXX XXXXX



EXT PNT: XX XXXXXX RC: XY DSO: XXXX
 WB INT TR TP/PS R AXLE TR SPR XXXX
 XXX XX XXX X XX X XXXX XXXX
 XXXXXXXXXXXXX XX = XXXX-XXXXXX-XX



E167814

Description	Code
Six-speed automatic transmission 6R80E	6

Capacities and Specifications

CAPACITIES AND SPECIFICATIONS - 2.7L ECOBOOST™

Capacities

WARNING



The air conditioning refrigerant system contains refrigerant R-134a under high pressure. Opening the air conditioning refrigerant system can cause personal injury. Have the air conditioning refrigerant system serviced only by qualified personnel.

Item	Capacity
Engine oil	6.0 qt (5.7 L)
Engine coolant	16.4 qt (15.5 L)
Brake fluid	Between MIN/MAX on brake fluid reservoir
Front axle fluid (Four-wheel drive)	3.5 pt (1.7 L)
Rear axle fluid	5.5 pt (2.6 L)
Automatic transmission fluid*	13.1 qt (12.4 L)
Transfer case fluid Four-wheel drive (Electronic Shift-on-the-Fly)	1.5 qt (1.4 L)
Transfer case fluid Automatic four-wheel drive (Torque on demand)	1.5 qt (1.4 L)
Windshield washer fluid	Fill as required
Fuel tank	23.0 gal (87.1 L)
Fuel tank (Optional)	36.0 gal (136.2 L)
A/C Refrigerant	1.5 lb (0.68 kg)
A/C Refrigerant Compressor Oil	3.4 fl oz (100.5 ml)

*Approximate dry fill capacity. Actual amount may vary during fluid changes.

Capacities and Specifications

Specifications

Materials

Name	Specification
Recommended motor oil (U.S.): Motorcraft SAE 5W-30 Premium Synthetic Blend Motor Oil XO-5W30-QSP	WSS-M2C946-A
Recommended Motor oil (Canada): Motorcraft SAE 5W-30 Super Premium Motor Oil CXO-5W30-LSP12	WSS-M2C946-A
Recommended motor oil (Mexico): Motorcraft SAE 5W-30 Synthetic Motor Oil MXO-5W30-QSP	WSS-M2C946-A
Optional motor oil (U.S. and Mexico): Motorcraft SAE 5W-30 Full Synthetic Motor Oil XO-5W30-QFS	WSS-M2C946-A
Optional Motor oil (Canada): Motorcraft SAE 5W-30 Synthetic Motor Oil CXO-5W30-LFS12	WSS-M2C946-A
Engine coolant (U.S. and Mexico): Motorcraft Orange Antifreeze/Coolant Prediluted VC-3DIL-B	WSS-M97B44-D2
Engine coolant (Canada): Motorcraft Orange Antifreeze/Coolant Prediluted CVC-3DIL-B	WSS-M97B44-D2
Brake fluid: Motorcraft DOT 4 Low Viscosity (LV) High Performance Motor Vehicle Brake Fluid PM-20	WSS-M6C65-A2
Front axle fluid (U.S.): Motorcraft SAE 80W-90 Premium Rear Axle Lubricant XY-80W90-QL	WSP-M2C197-A
Front axle fluid (Canada): Motorcraft SAE 80W-90 Premium Rear Axle Lubricant CXY-80W90-1L	WSP-M2C197-A
Front axle fluid (Mexico): Motorcraft SAE 80W-90 Premium Rear Axle Lubricant MXY-80W90-QL	WSP-M2C197-A

Capacities and Specifications

Name	Specification
Rear axle fluid: Motorcraft SAE 75W-85 Premium Synthetic Hypoid Gear Lubricant XY-75W85-QL	WSS-M2C942-A
Automatic transmission fluid (U.S. and Mexico): Motorcraft MERCON LV Automatic Transmission Fluid XT-10-QLVC	WSS-M2C938-A MERCON LV
Automatic transmission fluid (Canada): Motorcraft MERCON LV Automatic Transmission Fluid CXT-10-LV12	WSS-M2C938-A MERCON LV
Transfer case fluid (Electronic Shift-On-the-Fly) (U.S. and Mexico): Motorcraft Transfer Case Fluid XL-12	ESP-M2C166-H
Transfer case fluid (Electronic Shift-On-the-Fly) (Canada): Motorcraft Transfer Case Fluid CXL-12	ESP-M2C166-H
Transfer case fluid (Torque On Demand) (U.S. and Mexico): Motorcraft MERCON LV Automatic Transmission Fluid XT-10-QLVC	WSS-M2C938-A MERCON LV
Transfer case fluid (Torque On Demand) (Canada): Motorcraft MERCON LV Automatic Transmission Fluid CXT-10-LV12	WSS-M2C938-A MERCON LV
Windshield washer fluid (U.S. and Mexico): Motorcraft Premium Windshield Wash Concentrate with Bitterant ZC-32-B2	WSS-M14P19-A
Windshield washer fluid (Canada): Motorcraft Premium Quality Windshield Washer Fluid CXC-37-(A, B, D, F)	WSS-M14P19-A
A/C refrigerant (U.S.): Motorcraft R-134a Refrigerant YN-19	WSH-M17B19-A
A/C refrigerant (Canada): Motorcraft R-134a Refrigerant CYN-16-R	WSH-M17B19-A

Capacities and Specifications

Name	Specification
A/C refrigerant (Mexico): Motorcraft R-134a Refrigerant MYN-19	WSH-M17B19-A
A/C refrigerant compressor oil: Motorcraft PAG Refrigerant Compressor Oil YN-12-D	WSH-M1C231-B
Transmission, parking brake linkage and pivots and brake pedal shift grease: Premium Long-Life Grease XG-1-E1	ESA-M1C75-B
Multi-purpose grease: Motorcraft Multi-Purpose Grease Spray XL-5	ESB-M1C93-B
Lock cylinders (U.S.): Penetrating and Lock Lubricant XL-1	--
Lock cylinders (Canada): Penetrating Fluid CXC-51-A	--
Lock cylinders (Mexico): Penetrating and Lock Lubricant MXL-1	--

If you use oil and fluids that do not meet the defined specification and viscosity grade, this may lead to:

- Component damage which is not covered by the vehicle warranty.
- Longer engine cranking periods.
- Increased emission levels.
- Reduced engine performance.
- Reduced fuel economy.
- Degraded brake performance.

We recommend Motorcraft motor oil for your vehicle. If Motorcraft oil is not available, use motor oils of the recommended viscosity grade that meet API SN requirements and display the API Certification Mark for gasoline engines. Do not use oil labeled with API SN service category unless the label also displays the API certification mark.

Capacities and Specifications



E142732

An oil that displays this symbol conforms to current engine, emission system and fuel economy performance standards of the International Lubricants Specification Advisory Council (ILSAC).

Do not use supplemental engine oil additives because they are unnecessary and could lead to engine damage that may not be covered by your vehicle warranty.

Note: Ford recommends using DOT 4 Low Viscosity (LV) High Performance Brake Fluid or equivalent meeting WSS-M6C65-A2. Use of any fluid other than the recommended fluid may cause degraded brake performance and not meet the Ford performance standards. Keep brake fluid clean and dry. Contamination with dirt, water, petroleum products or other materials may result in brake system damage and possible failure.

Note: Automatic transmissions that require MERCON LV transmission fluid should only use MERCON LV transmission fluid. The use of any other fluid may cause transmission damage.

CAPACITIES AND SPECIFICATIONS - 3.5L ECOBOOST™

Capacities

WARNING



The air conditioning refrigerant system contains refrigerant R-134a under high pressure. Opening the air conditioning refrigerant system can cause personal injury. Have the air conditioning refrigerant system serviced only by qualified personnel.

Item	Capacity
Engine oil	6.0 qt (5.7 L)
Engine coolant	15.6 qt (14.75 L)
Brake fluid	Between MIN/MAX on brake fluid reservoir
Front axle fluid (Four-wheel drive)	3.5 pt (1.7 L)
Rear axle fluid	5.5 pt (2.6 L)
Automatic transmission fluid*	13.1 qt (12.4 L)
Transfer case fluid Four-wheel drive (Electronic Shift-on-the-Fly)	1.5 qt (1.4 L)

Capacities and Specifications

Item	Capacity
Transfer case fluid Automatic four-wheel drive (Torque on demand)	1.5 qt (1.4 L)
Windshield washer fluid	Fill as required
Fuel tank	23.0 gal (87.1 L)
Fuel tank (Optional)	36.0 gal (136.2 L)
A/C Refrigerant	1.5 lb (0.68 kg)
A/C Refrigerant Compressor Oil	3.4 fl oz (100.5 ml)

*Approximate dry fill capacity. Actual amount may vary during fluid changes.

Specifications

Materials

Name	Specification
Recommended motor oil (U.S.): Motorcraft SAE 5W-30 Premium Synthetic Blend Motor Oil XO-5W30-QSP	WSS-M2C946-A
Recommended Motor oil (Canada): Motorcraft SAE 5W-30 Super Premium Motor Oil CXO-5W30-LSP12	WSS-M2C946-A
Recommended motor oil (Mexico): Motorcraft SAE 5W-30 Synthetic Motor Oil MXO-5W30-QSP	WSS-M2C946-A
Optional motor oil (U.S. and Mexico): Motorcraft SAE 5W-30 Full Synthetic Motor Oil XO-5W30-QFS	WSS-M2C946-A
Optional Motor oil (Canada): Motorcraft SAE 5W-30 Synthetic Motor Oil CXO-5W30-LFS12	WSS-M2C946-A
Engine coolant (U.S. and Mexico): Motorcraft Orange Antifreeze/Coolant Prediluted VC-3DIL-B	WSS-M97B44-D2
Engine coolant (Canada):	WSS-M97B44-D2

Capacities and Specifications

Name	Specification
Motorcraft Orange Antifreeze/Coolant Prediluted CVC-3DIL-B	
Brake fluid: Motorcraft DOT 4 Low Viscosity (LV) High Performance Motor Vehicle Brake Fluid PM-20	WSS-M6C65-A2
Front axle fluid (U.S.): Motorcraft SAE 80W-90 Premium Rear Axle Lubricant XY-80W90-QL	WSP-M2C197-A
Front axle fluid (Canada): Motorcraft SAE 80W-90 Premium Rear Axle Lubricant CXY-80W90-IL	WSP-M2C197-A
Front axle fluid (Mexico): Motorcraft SAE 80W-90 Premium Rear Axle Lubricant MXY-80W90-QL	WSP-M2C197-A
Rear axle fluid: Motorcraft SAE 75W-85 Premium Synthetic Hypoid Gear Lubricant XY-75W85-QL	WSS-M2C942-A
Automatic transmission fluid (U.S. and Mexico): Motorcraft MERCON LV Automatic Transmission Fluid XT-10-QLVC	WSS-M2C938-A MERCON LV
Automatic transmission fluid (Canada): Motorcraft MERCON LV Automatic Transmission Fluid CXT-10-LV12	WSS-M2C938-A MERCON LV
Transfer case fluid (Electronic Shift-On-the-Fly) (U.S. and Mexico): Motorcraft Transfer Case Fluid XL-12	ESP-M2C166-H
Transfer case fluid (Electronic Shift-On-the-Fly) (Canada): Motorcraft Transfer Case Fluid CXL-12	ESP-M2C166-H
Transfer case fluid (Torque On Demand) (U.S. and Mexico): Motorcraft MERCON LV Automatic Transmission Fluid XT-10-QLVC	WSS-M2C938-A MERCON LV
Transfer case fluid (Torque On Demand) (Canada):	WSS-M2C938-A

Capacities and Specifications

Name	Specification
Motorcraft MERCON LV Automatic Transmission Fluid CXT-10-LV12	MERCON LV
Windshield washer fluid (U.S. and Mexico): Motorcraft Premium Windshield Wash Concentrate with Bitterant ZC-32-B2	WSS-M14P19-A
Windshield washer fluid (Canada): Motorcraft Premium Quality Windshield Washer Fluid CXC-37-(A, B, D, F)	WSS-M14P19-A
A/C refrigerant (U.S.): Motorcraft R-134a Refrigerant YN-19	WSH-M17B19-A
A/C refrigerant (Canada): Motorcraft R-134a Refrigerant CYN-16-R	WSH-M17B19-A
A/C refrigerant (Mexico): Motorcraft R-134a Refrigerant MYN-19	WSH-M17B19-A
A/C refrigerant compressor oil: Motorcraft PAG Refrigerant Compressor Oil YN-12-D	WSH-M1C231-B
Transmission, parking brake linkage and pivots and brake pedal shift grease: Premium Long-Life Grease XG-1-E1	ESA-M1C75-B
Multi-purpose grease: Motorcraft Multi-Purpose Grease Spray XL-5	ESB-M1C93-B
Lock cylinders (U.S.): Penetrating and Lock Lubricant XL-1	--
Lock cylinders (Canada): Penetrating Fluid CXC-51-A	--
Lock cylinders (Mexico): Penetrating and Lock Lubricant MXL-1	--

Capacities and Specifications

If you use oil and fluids that do not meet the defined specification and viscosity grade, this may lead to:

- Component damage which is not covered by the vehicle warranty.
- Longer engine cranking periods.
- Increased emission levels.
- Reduced engine performance.
- Reduced fuel economy.
- Degraded brake performance.

We recommend Motorcraft motor oil for your vehicle. If Motorcraft oil is not available, use motor oils of the recommended viscosity grade that meet API SN requirements and display the API Certification Mark for gasoline engines. Do not use oil labeled with API SN service category unless the label also displays the API certification mark.



E142732

CAPACITIES AND SPECIFICATIONS - 3.5L

Capacities

WARNING



The air conditioning refrigerant system contains refrigerant R-134a under high pressure. Opening the air conditioning refrigerant system can cause personal injury. Have the air conditioning refrigerant system serviced only by qualified personnel.

An oil that displays this symbol conforms to current engine, emission system and fuel economy performance standards of the International Lubricants Specification Advisory Council (ILSAC).

Do not use supplemental engine oil additives because they are unnecessary and could lead to engine damage that may not be covered by your vehicle warranty.

Note: *Ford recommends using DOT 4 Low Viscosity (LV) High Performance Brake Fluid or equivalent meeting WSS-M6C65-A2. Use of any fluid other than the recommended fluid may cause degraded brake performance and not meet the Ford performance standards. Keep brake fluid clean and dry. Contamination with dirt, water, petroleum products or other materials may result in brake system damage and possible failure.*

Note: *Automatic transmissions that require MERCON LV transmission fluid should only use MERCON LV transmission fluid. The use of any other fluid may cause transmission damage.*

Capacities and Specifications

Item	Capacity
Engine oil	6.3 qt (6 L)
Engine coolant	15.1 qt (14.25 L)
Brake fluid	Between MIN/MAX on brake fluid reservoir
Front axle fluid (Four-wheel drive)	3.5 pt (1.7 L)
Rear axle fluid	5.5 pt (2.6 L)
Automatic transmission fluid*	13.1 qt (12.4 L)
Transfer case fluid Four-wheel drive (Electronic Shift-on-the-Fly)	1.5 qt (1.4 L)
Transfer case fluid Automatic four-wheel drive (Torque on demand)	1.5 qt (1.4 L)
Windshield washer fluid	Fill as required
Fuel tank	23.0 gal (87.1 L)
Fuel tank (Optional)	36.0 gal (136.2 L)
A/C Refrigerant	1.5 lb (0.68 kg)
A/C Refrigerant Compressor Oil	3.4 fl oz (100.5 ml)

*Approximate dry fill capacity. Actual amount may vary during fluid changes.

Specifications

Materials

Name	Specification
Recommended motor oil (U.S.): Motorcraft SAE 5W-20 Premium Synthetic Blend Motor Oil XO-5W20-QSP	WSS-M2C945-A
Recommended motor oil (Canada): Motorcraft SAE 5W-20 Super Premium Motor Oil CXO-5W20-LSP12	WSS-M2C945-A
Recommended motor oil (Mexico): Motorcraft SAE 5W-20 Synthetic Motor Oil	WSS-M2C945-A

Capacities and Specifications

Name	Specification
MXO-5W20-QSP	
Optional motor oil (U.S. and Mexico): Motorcraft SAE 5W-20 Full Synthetic Motor Oil XO-5W20-QFS	WSS-M2C945-A
Optional motor oil (Canada): Motorcraft SAE 5W-20 Synthetic Motor Oil CXO-5W20-LFS12	WSS-M2C945-A
Engine coolant (U.S. and Mexico): Motorcraft Orange Antifreeze/Coolant Prediluted VC-3DIL-B	WSS-M97B44-D2
Engine coolant (Canada): Motorcraft Orange Antifreeze/Coolant Prediluted CVC-3DIL-B	WSS-M97B44-D2
Brake fluid: Motorcraft DOT 4 Low Viscosity (LV) High Performance Motor Vehicle Brake Fluid PM-20	WSS-M6C65-A2
Front axle fluid (U.S.): Motorcraft SAE 80W-90 Premium Rear Axle Lubricant XY-80W90-QL	WSP-M2C197-A
Front axle fluid (Canada): Motorcraft SAE 80W-90 Premium Rear Axle Lubricant CXY-80W90-1L	WSP-M2C197-A
Front axle fluid (Mexico): Motorcraft SAE 80W-90 Premium Rear Axle Lubricant MXY-80W90-QL	WSP-M2C197-A
Rear axle fluid: Motorcraft SAE 75W-85 Premium Synthetic Hypoid Gear Lubricant XY-75W85-QL	WSS-M2C942-A
Automatic transmission fluid (U.S. and Mexico): Motorcraft MERCON LV Automatic Transmission Fluid XT-10-QLVC	WSS-M2C938-A MERCON LV
Automatic transmission fluid (Canada): Motorcraft MERCON LV Automatic Transmission Fluid CXT-10-LV12	WSS-M2C938-A MERCON LV

Capacities and Specifications

Name	Specification
Transfer case fluid (Electronic Shift-On-the-Fly) (U.S. and Mexico): Motorcraft Transfer Case Fluid XL-12	ESP-M2C166-H
Transfer case fluid (Electronic Shift-On-the-Fly) (Canada): Motorcraft Transfer Case Fluid CXL-12	ESP-M2C166-H
Transfer case fluid (Torque On Demand) (U.S. and Mexico): Motorcraft MERCON LV Automatic Transmission Fluid XT-10-QLVC	WSS-M2C938-A MERCON LV
Transfer case fluid (Torque On Demand) (Canada): Motorcraft MERCON LV Automatic Transmission Fluid CXT-10-LV12	WSS-M2C938-A MERCON LV
Windshield washer fluid (U.S. and Mexico): Motorcraft Premium Windshield Wash Concentrate with Bitterant ZC-32-B2	WSS-M14P19-A
Windshield washer fluid (Canada): Motorcraft Premium Quality Windshield Washer Fluid CXC-37-(A, B, D, F)	WSS-M14P19-A
A/C refrigerant (U.S.): Motorcraft R-134a Refrigerant YN-19	WSH-M17B19-A
A/C refrigerant (Canada): Motorcraft R-134a Refrigerant CYN-16-R	WSH-M17B19-A
A/C refrigerant (Mexico): Motorcraft R-134a Refrigerant MYN-19	WSH-M17B19-A
A/C refrigerant compressor oil: Motorcraft PAG Refrigerant Compressor Oil YN-12-D	WSH-MIC231-B
Transmission, parking brake linkage and pivots and brake pedal shift grease: Premium Long-Life Grease XG-1-E1	ESA-MIC75-B

Capacities and Specifications

Name	Specification
Multi-purpose grease: Motorcraft Multi-Purpose Grease Spray XL-5	ESB-MIC93-B
Lock cylinders (U.S. and Mexico): Penetrating and Lock Lubricant XL-1	--
Lock cylinders (Canada): Penetrating Fluid CXC-51-A	--
Lock cylinders (Mexico): Penetrating and Lock Lubricant MXL-1	--

If you use oil and fluids that do not meet the defined specification and viscosity grade, this may lead to:

- Component damage which is not covered by the vehicle warranty.
- Longer engine cranking periods.
- Increased emission levels.
- Reduced engine performance.
- Reduced fuel economy.
- Degraded brake performance.

We recommend Motorcraft motor oil for your vehicle. If Motorcraft oil is not available, use motor oils of the recommended viscosity grade that meet API SN requirements and display the API Certification Mark for gasoline engines. Do not use oil labeled with API SN service category unless the label also displays the API certification mark.



E142732

An oil that displays this symbol conforms to current engine, emission system and fuel economy performance standards of the International Lubricants Specification Advisory Council (ILSAC).

Do not use supplemental engine oil additives because they are unnecessary and could lead to engine damage that may not be covered by your vehicle warranty.

Capacities and Specifications

Note: Ford recommends using DOT 4 Low Viscosity (LV) High Performance Brake Fluid or equivalent meeting WSS-M6C65-A2. Use of any fluid other than the recommended fluid may cause degraded brake performance and not meet the Ford performance standards. Keep brake fluid clean and dry. Contamination with dirt, water, petroleum products or other materials may result in brake system damage and possible failure.

Note: Automatic transmissions that require MERCON LV transmission fluid should only use MERCON LV transmission fluid. The use of any other fluid may cause transmission damage.

CAPACITIES AND SPECIFICATIONS - 5.0L

Capacities

WARNING



The air conditioning refrigerant system contains refrigerant R-134a under high pressure. Opening the air conditioning refrigerant system can cause personal injury. Have the air conditioning refrigerant system serviced only by qualified personnel.

Item	Capacity
Engine oil	7.7 qt (7.3 L)
Engine coolant	15.9 qt (15 L)
Brake fluid	Between MIN/MAX on brake fluid reservoir
Front axle fluid (Four-wheel drive)	3.5 pt (1.7 L)
Rear axle fluid	5.5 pt (2.6 L)
Automatic transmission fluid*	13.1 qt (12.4 L)
Transfer case fluid Four-wheel drive (Electronic Shift-on-the-Fly)	1.5 qt (1.4 L)
Transfer case fluid Automatic four-wheel drive (Torque on demand)	1.5 qt (1.4 L)
Windshield washer fluid	Fill as required
Fuel tank	23.0 gal (87.1 L)
Fuel tank (Optional)	36.0 gal (136.2 L)

Capacities and Specifications

Item	Capacity
A/C Refrigerant	1.5 lb (0.68 kg)
A/C Refrigerant Compressor Oil	3.4 fl oz (100.5 ml)

*Approximate dry fill capacity. Actual amount may vary during fluid changes.

Specifications

Materials

Name	Specification
Recommended motor oil (U.S.): Motorcraft SAE 5W-20 Premium Synthetic Blend Motor Oil XO-5W20-QSP	WSS-M2C945-A
Recommended motor oil (Canada): Motorcraft SAE 5W-20 Super Premium Motor Oil CXO-5W20-LSP12	WSS-M2C945-A
Recommended motor oil (Mexico): Motorcraft SAE 5W-20 Synthetic Motor Oil MXO-5W20-QSP	WSS-M2C945-A
Optional motor oil (U.S. and Mexico): Motorcraft SAE 5W-20 Full Synthetic Motor Oil XO-5W20-QFS	WSS-M2C945-A
Optional motor oil (Canada): Motorcraft SAE 5W-20 Synthetic Motor Oil CXO-5W20-LFS12	WSS-M2C945-A
Engine coolant (U.S. and Mexico): Motorcraft Orange Antifreeze/Coolant Prediluted VC-3DIL-B	WSS-M97B44-D2
Engine coolant (Canada): Motorcraft Orange Antifreeze/Coolant Prediluted CVC-3DIL-B	WSS-M97B44-D2
Brake fluid: Motorcraft DOT 4 Low Viscosity (LV) High Performance Motor Vehicle Brake Fluid PM-20	WSS-M6C65-A2
Front axle fluid (U.S.): Motorcraft SAE 80W-90 Premium Rear Axle Lubricant	WSP-M2C197-A

Capacities and Specifications

Name	Specification
XY-80W90-QL	
Front axle fluid (Canada): Motorcraft SAE 80W-90 Premium Rear Axle Lubricant CXY-80W90-1L	WSP-M2C197-A
Front axle fluid (Mexico): Motorcraft SAE 80W-90 Premium Rear Axle Lubricant MXY-80W90-QL	WSP-M2C197-A
Rear axle fluid: Motorcraft SAE 75W-85 Premium Synthetic Hypoid Gear Lubricant XY-75W85-QL	WSS-M2C942-A
Automatic transmission fluid (U.S. and Mexico): Motorcraft MERCON LV Automatic Transmission Fluid XT-10-QLVC	WSS-M2C938-A MERCON LV
Automatic transmission fluid (Canada): Motorcraft MERCON LV Automatic Transmission Fluid CXT-10-LV12	WSS-M2C938-A MERCON LV
Transfer case fluid (Electronic Shift-On-the-Fly) (U.S. and Mexico): Motorcraft Transfer Case Fluid XL-12	ESP-M2C166-H
Transfer case fluid (Electronic Shift-On-the-Fly) (Canada): Motorcraft Transfer Case Fluid CXL-12	ESP-M2C166-H
Transfer case fluid (Torque On Demand) (U.S. and Mexico): Motorcraft MERCON LV Automatic Transmission Fluid XT-10-QLVC	WSS-M2C938-A MERCON LV
Transfer case fluid (Torque On Demand) (Canada): Motorcraft MERCON LV Automatic Transmission Fluid CXT-10-LV12	WSS-M2C938-A MERCON LV
Windshield washer fluid (U.S. and Mexico): Motorcraft Premium Windshield Wash Concentrate with Bitterant ZC-32-B2	WSS-M14P19-A
Windshield washer fluid (Canada): Motorcraft Premium Quality Windshield Washer Fluid	WSS-M14P19-A

Capacities and Specifications

Name	Specification
CXC-37-(A, B, D, F)	
A/C refrigerant (U.S.): Motorcraft R-134a Refrigerant YN-19	WSH-M17B19-A
A/C refrigerant (Canada): Motorcraft R-134a Refrigerant CYN-16-R	WSH-M17B19-A
A/C refrigerant (Mexico): Motorcraft R-134a Refrigerant MYN-19	WSH-M17B19-A
A/C refrigerant compressor oil: Motorcraft PAG Refrigerant Compressor Oil YN-12-D	WSH-M1C231-B
Transmission, parking brake linkage and pivots and brake pedal shift grease: Premium Long-Life Grease XG-1-E1	ESA-M1C75-B
Multi-purpose grease: Motorcraft Multi-Purpose Grease Spray XL-5	ESB-M1C93-B
Lock cylinders (U.S.): Penetrating and Lock Lubricant XL-1	--
Lock cylinders (Canada): Penetrating Fluid CXC-51-A	--
Lock cylinders (Mexico): Penetrating and Lock Lubricant MXL-1	--

If you use oil and fluids that do not meet the defined specification and viscosity grade, this may lead to:

- Component damage which is not covered by the vehicle warranty.
- Longer engine cranking periods.
- Increased emission levels.

- Reduced engine performance.
- Reduced fuel economy.
- Degraded brake performance.

Capacities and Specifications

We recommend Motorcraft motor oil for your vehicle. If Motorcraft oil is not available, use motor oils of the recommended viscosity grade that meet API SN requirements and display the API Certification Mark for gasoline engines. Do not use oil labeled with API SN service category unless the label also displays the API certification mark.

Note: *Automatic transmissions that require MERCON LV transmission fluid should only use MERCON LV transmission fluid. The use of any other fluid may cause transmission damage.*



E142732

An oil that displays this symbol conforms to current engine, emission system and fuel economy performance standards of the International Lubricants Specification Advisory Council (ILSAC).

Do not use supplemental engine oil additives because they are unnecessary and could lead to engine damage that may not be covered by your vehicle warranty.

Note: *Ford recommends using DOT 4 Low Viscosity (LV) High Performance Brake Fluid or equivalent meeting WSS-M6C65-A2. Use of any fluid other than the recommended fluid may cause degraded brake performance and not meet the Ford performance standards. Keep brake fluid clean and dry. Contamination with dirt, water, petroleum products or other materials may result in brake system damage and possible failure.*

Audio System

GENERAL INFORMATION

Radio Frequencies and Reception Factors

AM and FM frequencies are established by the Federal Communications Commission (FCC) and the Canadian Radio and Telecommunications Commission (CRTC). Those frequencies are:

- AM: 530, 540-1700, 1710 kHz
- FM: 87.9-107.7, 107.9 MHz

Radio Reception Factors	
Distance and strength	The further you travel from an AM or FM station, the weaker the signal and the weaker the reception.
Terrain	Hills, mountains, tall buildings, bridges, tunnels, freeway overpasses, parking garages, dense tree foliage and thunderstorms can interfere with the reception.
Station overload	When you pass a ground-based broadcast repeating tower, a stronger signal may overtake a weaker one and result in the audio system muting.

CD and CD Player Information

Note: *CD units play commercially pressed 4.75-inch (12 centimeter) audio compact discs only. Due to technical incompatibility, certain recordable and re-recordable compact discs may not function correctly when used in Ford CD players.*

Note: *Do not insert CDs with homemade paper (adhesive) labels into the CD player as the label may peel and cause the CD to become jammed. You should use a permanent felt tip marker rather than adhesive labels on your homemade CDs. Ballpoint pens may damage CDs. Please contact an authorized dealer for further information.*

Note: *Do not use any irregularly shaped discs or discs with a scratch protection film attached.*

Always handle discs by their edges only. Clean the disc with an approved CD cleaner only. Wipe it from the center of the disc toward the edge. Do not clean in a circular motion.

Do not expose discs to direct sunlight or heat sources for extended periods.

MP3 and WMA Track and Folder Structure

Audio systems capable of recognizing and playing MP3 and WMA individual tracks and folder structures work as follows:

- There are two different modes for MP3 and WMA disc playback: MP3 and WMA track mode (system default) and MP3 and WMA folder mode.
- MP3 and WMA track mode ignores any folder structure on the MP3 and WMA disc. The player numbers each MP3 and WMA track on the disc (noted by the MP3 or WMA file extension) from T001 to a maximum of T255. The maximum number of playable MP3 and WMA files may be less depending on the structure of the CD and exact model of radio present.

Audio System

- MP3 and WMA folder mode represents a folder structure consisting of one level of folders. The CD player numbers all MP3 and WMA tracks on the disc (noted by the MP3 or WMA file extension) and all folders containing MP3 and WMA files, from F001 (folder) T001 (track) to F253 T255.
- Creating discs with only one level of folders helps with navigation through the disc files.

If you are burning your own MP3 and WMA discs, it is important to understand how the system reads the structures you create. While various files may be present (files with extensions other than MP3 and WMA), only files with the MP3 and WMA extension are played; other files are ignored by the system. This enables you to use the same MP3 and WMA disc for a variety of tasks on your work computer, home computer and your in-vehicle system.

In track mode, the system displays and plays the structure as if it were only one level deep (all MP3 and WMA files play, regardless of being in a specific folder). In folder mode, the system only plays the MP3 and WMA files in the current folder.

AUDIO UNIT - VEHICLES WITH: AM/FM

WARNING



Driving while distracted can result in loss of vehicle control, crash and injury. We strongly recommend that you use extreme caution when using any device that may take your focus off the road. Your primary responsibility is the safe operation of your vehicle. We recommend against the use of any hand-held device while driving and encourage the use of voice-operated systems when possible. Make sure you are aware of all applicable local laws that may affect the use of electronic devices while driving.

Note: *Your audio system may not be equipped with a CD player.*

Audio System

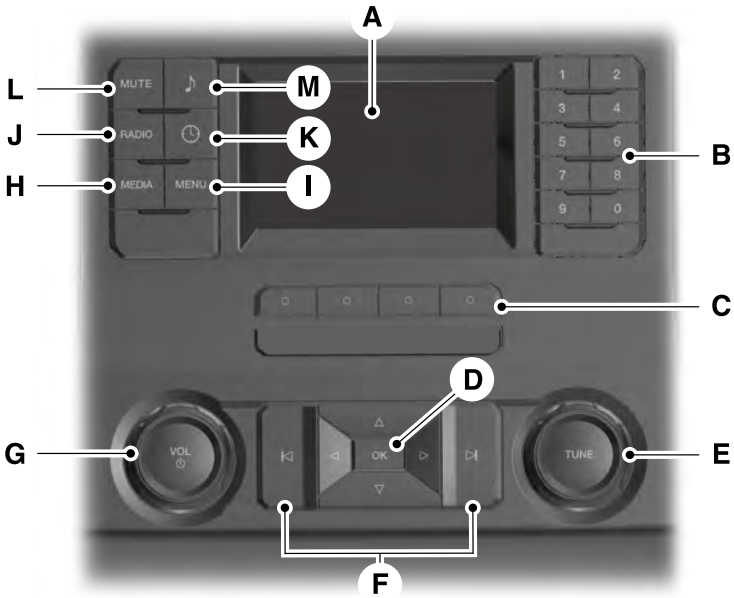

E176101

- A **Display screen:** View audio and SYNC options.
- B **Number block:** Store your favorite radio stations. To store a radio station, tune to the station, then press and hold a preset button until sound returns.
- C **Function buttons:** Select different functions of the audio system depending on which mode you are in (such as Radio mode).
- D **Cursor arrows and OK:** Use the up and down arrow buttons to select the various settings. When you make your selection, press the left and right arrow buttons to change the settings.
Press **OK** to set or press **MENU** to exit.
- E **TUNE:** Turn to search the frequency band in individual increments.
- F **Seek:** Select a frequency band and press these buttons. The system stops at the first station up or down the band. Press and hold the button to move quickly to the next strong radio station or memory preset.
- G **VOL and Power:** Press this button to switch the system off and on. Turn it to adjust the volume.

Audio System

- H **MEDIA:** Press this button to access your auxiliary input jack or switch between devices you plug into the input jack or USB port.
- I **MENU:** Press this button to access different audio system features.
- J **RADIO:** Press this button to listen to the radio or change radio frequency bands. Press the function buttons below the radio screen to select different radio functions.
- K **Clock:** Press this button to access the clock setting. Use the center arrow controls to change the hours and minutes.
You can also set the clock by pressing the **MENU** button and scrolling to Clock Settings.
- L **Mute:** Press this button to mute the playing media.
- M **Sound:** Press this button to access settings for Treble, Midrange, Bass, Fade and Balance.

AUDIO UNIT - VEHICLES WITH: AM/FM/CD

WARNING



Driving while distracted can result in loss of vehicle control, crash and injury. We strongly recommend that you use extreme caution when using any device that may take your focus off the road. Your primary responsibility is the safe operation of your vehicle. We recommend against the use of any hand-held device while driving and encourage the use of voice-operated systems when possible. Make sure you are aware of all applicable local laws that may affect the use of electronic devices while driving.

Audio System

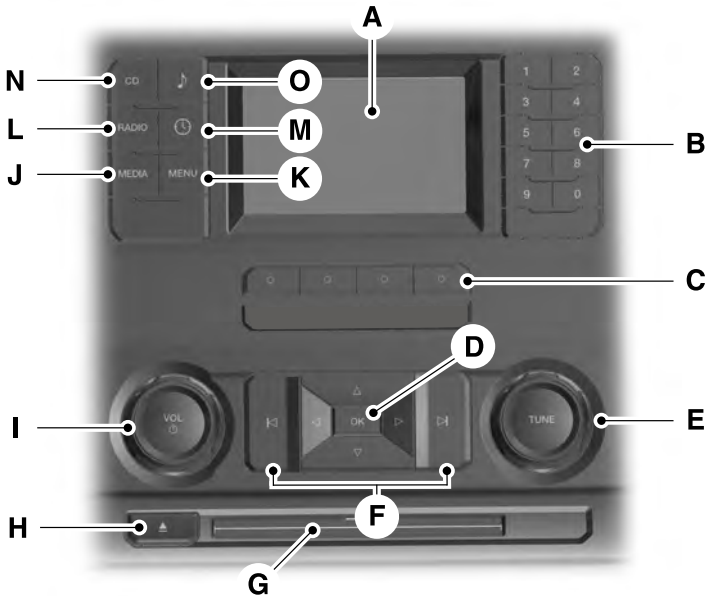

E176104

A **Display screen:** View audio and SYNC options.

B **Number block:**

In radio mode, store your favorite stations for later access. When tuned to any station, press and hold a preset button until sound returns.

In CD mode, press a button to select a track. In phone mode, press the buttons to enter a phone number.

C **Function buttons:** Select different functions of the audio system depending on which mode you are in (such as Radio mode or CD mode).

D **Cursor arrows and OK:** Use the up and down arrow buttons to select the various settings. When you make your selection, press the left and right arrow buttons to change the settings.

Press **OK** to set or press **MENU** to exit.

E **TUNE:** Turn to search the frequency band in individual increments.

F **Seek:**

Audio System

In radio mode, select a frequency band and press these buttons. The system stops at the first station up the band. Press and hold the button to move quickly to the next strong radio station or memory preset.

In CD mode, press this button to select the next track. Press and hold the button to move quickly forward through the current track.

- G **CD slot:** Insert a CD.
- H **Eject:** Press this button to eject a CD.
- I **VOL and Power:** Press this button to switch the system off and on. Turn it to adjust the volume.
- J **MEDIA:** Press this button to access your auxiliary input jack or switch between devices you plug into the input jack or USB port.
- K **MENU:** Press this button to access different audio system features.
- L **RADIO:** Press this button to listen to the radio or change radio frequency bands. Press the function buttons below the radio screen to select different radio functions.
- M **Clock:** Press this button to access the clock setting. Use the center arrow controls to change the hours and minutes.
You can also set the clock by pressing the **MENU** button and scrolling to Clock Settings.
- N **CD:** Press this button to listen to a CD. Press the function buttons below the radio screen to select on-screen options of Repeat or Shuffle.
- O **Sound:** Press this button to access settings for Treble, Midrange, Bass, Fade and Balance.

Audio System

AUDIO UNIT - VEHICLES WITH: AM/FM/SYNC

WARNING



Driving while distracted can result in loss of vehicle control, crash and injury. We strongly recommend that you use extreme caution when using any device that may take your focus off the road. Your primary responsibility is the safe operation of your vehicle. We recommend against the use of any hand-held device while driving and encourage the use of voice-operated systems when possible. Make sure you are aware of all applicable local laws that may affect the use of electronic devices while driving.

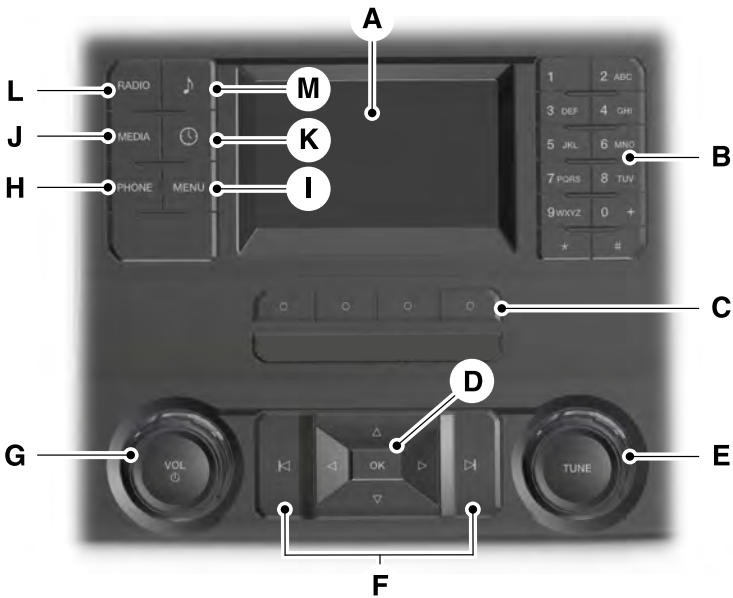

E176102

A Display screen: View audio and SYNC options.

B Number block:

In radio mode, store your favorite stations for later access. When tuned to any station, press and hold a preset button until sound returns.

Audio System

In phone mode, press the buttons to dial a phone number.

- C **Function buttons:** Select different functions of the audio system depending on which mode you are in (such as Radio mode).
- D **Cursor arrows and OK:** Use the up and down arrow buttons to select the various settings. When you make your selection, press the left and right arrow buttons to change the settings.
Press **OK** to set or press **MENU** to exit.
- E **TUNE:** Turn to search the frequency band in individual increments.
- F **Seek:** Select a frequency band and press these buttons. The system stops at the first station up the band. Press and hold the button to move quickly to the next strong radio station or memory preset.
- G **VOL and Power:** Press this button to switch the system off and on. Turn it to adjust the volume.
- H **PHONE:** Press this button to access the phone features of the SYNC system. See **SYNC™** (page 402).
- I **MENU:** Press this button to access different audio system features.
- J **MEDIA:** Press this button to access your auxiliary input jack or switch between devices you plug into the input jack or USB port.
- K **Clock:** Press this button to access the clock setting. Use the center arrow controls to change the hours and minutes.
You can also set the clock by pressing the **MENU** button and scrolling to Clock Settings.
- L **RADIO:** Press this button to listen to the radio or change radio frequency bands. Press the function buttons below the radio screen to select different radio functions.
- M **Sound:** Press this button to access settings for Treble, Midrange, Bass, Fade and Balance.

Audio System

AUDIO UNIT - VEHICLES WITH: AM/FM/CD/SYNC/SATELLITE RADIO

WARNING



Driving while distracted can result in loss of vehicle control, crash and injury. We strongly recommend that you use extreme caution when using any device that may take your focus off the road. Your primary responsibility is the safe operation of your vehicle. We recommend against the use of any handheld device while driving and encourage the use of voice-operated systems when possible. Make sure you are aware of all applicable local laws that may affect the use of electronic devices while driving.

Note: Some features, such as Sirius satellite radio, may not be available in your location. Check with an authorized dealer.

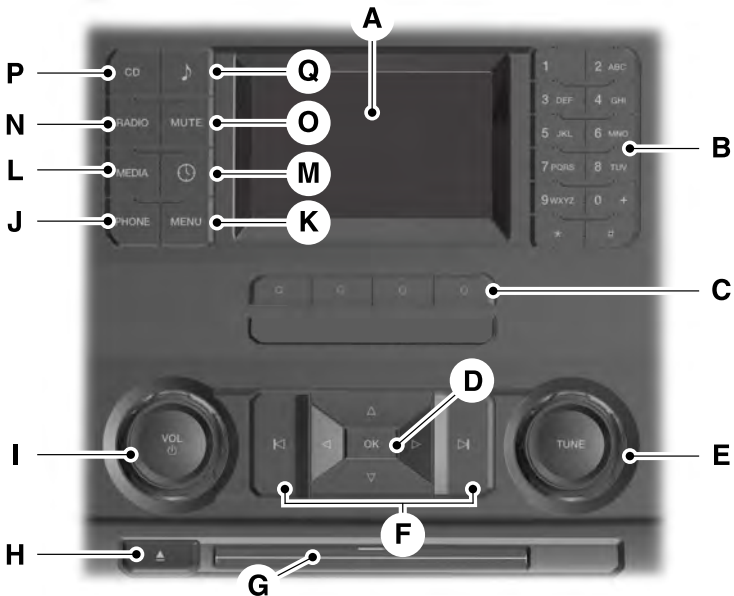

E176103

Audio System

- A **Display screen:** View audio and SYNC options.
- B **Number block:**

In radio mode, store your favorite stations for later access. When tuned to any station, press and hold a preset button until sound returns.

In CD mode, press a button to select a track.

In phone mode, press the buttons to dial a phone number.
- C **Function buttons:** Select different functions of the audio system depending on which mode you are in (such as Radio mode or CD mode).
- D **Cursor arrows and OK:** Use the up and down arrow buttons to select the various settings. When you make your selection, press the left and right arrow buttons to change the settings.

Press **OK** to set or press **MENU** to exit.
- E **TUNE:** Turn to search the frequency band in individual increments.
- F **Seek:**

In radio mode, select a frequency band and press these buttons. The system stops at the first station up the band. Press and hold the button to move quickly to the next strong radio station or memory preset.

In CD mode, press this button to select the next track. Press and hold the button to move quickly forward through the current track.
- G **CD slot:** Insert a CD.
- H **Eject:** Press this button to eject a CD.
- I **VOL and Power:** Press this button to switch the system off and on. Turn it to adjust the volume.
- J **PHONE:** Press this button to access the phone features of the SYNC system. See **SYNC™** (page 402).
- K **MENU:** Press this button to access different audio system features.
- L **MEDIA:** Press this button to access your auxiliary input jack or switch between devices you plug into the input jack or USB port.
- M **Clock:** Press this button to access the clock setting. Use the center arrow controls to change the hours and minutes.

You can also set the clock by pressing the **MENU** button and scrolling to Clock Settings.
- N **RADIO:** Press this button to listen to the radio or change radio frequency bands. Press the function buttons below the radio screen to select different radio functions.

Audio System

- **SIRIUS or MUTE:** If your vehicle is equipped with Sirius satellite radio, press this button to listen to Sirius satellite radio. If your vehicle is not equipped with Sirius satellite radio, press the button to mute the playing media.
- P **CD:** Press this button to listen to a CD. Press the function buttons below the radio screen to select on-screen options of Repeat or Shuffle.
- Q **Sound:** Press this button to access settings for Treble, Midrange, Bass, Fade and Balance.

AUDIO UNIT - VEHICLES WITH: SONY AM/FM/CD

Note: *The MyFord Touch system controls most of the audio features. See **Entertainment** (page 453).*

WARNING



Driving while distracted can result in loss of vehicle control, crash and injury. We strongly recommend that you use extreme caution when using any device that may take your focus off the road. Your primary responsibility is the safe operation of your vehicle. We recommend against the use of any hand-held device while driving and encourage the use of voice-operated systems when possible. Make sure you are aware of all applicable local laws that may affect the use of electronic devices while driving.

Audio System

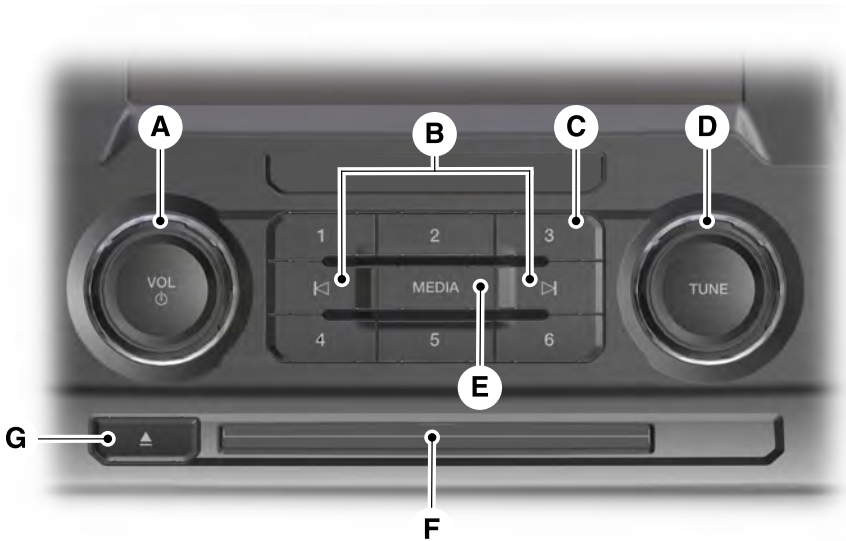

E176105

- A **VOL** and **Power**: Press this button to switch the system off and on. Turn it to adjust the volume.
- B **Seek, Reverse and Fast Forward**:
In radio mode, select a frequency band and press one of these buttons. The system stops at the first station it finds in that direction.
In CD mode, press these buttons to select the previous or next track.
- C **Memory presets**: Store your favorite radio stations. To store a radio station, tune to the station, then press and hold a preset button until sound returns.
- D **TUNE**: Turn to search the frequency band in individual increments.
- E **MEDIA**: Press this button to access different audio modes, such as AM, FM and Line In.
- F **CD slot**: Insert a CD.
- G **Eject**: Press this button to eject a CD.

Audio System

DIGITAL RADIO

Note: *HD Radio broadcasts are not available in all markets.*

HD Radio technology is the digital evolution of analog AM/FM radio. Your system has a special receiver that allows it to receive digital broadcasts (where available) in addition to the analog broadcasts, it already receives. Digital broadcasts provide a better sound quality than analog broadcasts with free, crystal-clear audio and no static or distortion. For more information, and a guide to available stations and programming, please visit www.hdradio.com.

When HD Radio is on and you tune to a station broadcasting HD Radio technology, you may notice the HD Radio logo on your screen. When this logo is available, you may also see Title and Artist fields on-screen.

The multicast indicator appears in FM mode (only) if the current station is broadcasting multiple digital broadcasts. The highlighted numbers signify available digital channels where new or different content is available. HD1 signifies the main programming status and is available in analog and digital broadcasts. Other multicast stations (HD2 through HD7) are only available digitally.

When HD Radio broadcasts are active, you can access the following functions:

- **Scan** allows you to hear a brief sampling of all available stations. This feature still works when HD Radio reception is on, although it does not scan for HD2-HD7 channels. You may see the HD logo appear if the station has a digital broadcast.
- **Memory presets** allow you to save an active channel as a memory preset. Touch and hold a memory preset slot until the sound returns. There is a brief mute while the radio saves the station. Sound returns when finished. When switching to an HD2 or HD3 memory preset, the sound mutes before the digital audio plays, because the system has to reacquire the digital signal.

Note: *As with any saved radio station, you cannot access the saved station if your vehicle is outside the station's reception area.*

Audio System

HD Radio Reception and Station Troubleshooting

Potential reception issues	
Reception area	If you are listening to a multicast station and you are on the fringe of the reception area, the station may mute due to weak signal strength.
	If you are listening to HD1, the system switches back to the analog broadcast until the digital broadcast is available again. However, if you are listening to any of the possible HD2-HD7 multicast channels, the station mutes and stays muted unless it is able to connect to the digital signal again.
Station blending	When the system first receives a station (aside from HD2-HD7 multicast stations), it first plays the station in the analog version. Once the receiver verifies the station is an HD Radio station, it shifts to the digital version. Depending on the station quality, you may hear a slight sound change when the station changes from analog to digital. Blending is the shift from analog to digital sound or digital back to analog sound.

In order to provide the best possible experience, use the contact form to report any station issues found while listening to a station broadcasting with HD Radio technology. Independent entities own and operate each station. These stations are responsible for ensuring all audio streams and data fields are accurate.

Audio System

Potential station issues		
Issues	Cause	Action
Echo, stutter, skip or repeat in audio. Increase or decrease in audio volume.	This is poor time alignment by the radio broadcaster.	No action required. This is a broadcast issue.
Sound fading or blending in and out.	The radio is shifting between analog and digital audio.	No action required. The reception issue may clear up as you continue to drive.
There is an audio mute delay when selecting HD2 or HD3, multicast preset or Direct Tune .	The digital multicast is not available until the HD Radio broadcast is decoded. Once decoded, the audio is available.	No action required. This is normal behavior. Wait until the audio is available.
Cannot access HD2 or HD3 multicast channel when recalling a preset or from a direct tune.	The previously stored multicast preset or direct tune is not available in your current reception area.	No action required. The station is not available in your current location.
Text information does not match currently playing audio.	Data service issue by the radio broadcaster.	Fill out the station issue form at website listed below.*
There is no text information shown for currently selected frequency.	Data service issue by the radio broadcaster.	Fill out the station issue form at website listed below.*
HD2-HD7 stations not found when Scan is pressed.	Pressing Scan disables HD2-HD7 channel search.	No action required. This is normal behavior.

* http://www.ibiquity.com/automotive/report_radio_station_experiences

HD Radio Technology manufactured under license from iBiquity Digital Corp. U.S. and foreign patents. HD Radio and the HD and HD Radio logos are proprietary trademarks of iBiquity Digital Corp. Ford Motor Company and iBiquity Digital Corp. are not responsible for the content sent using HD Radio technology. Content may be changed, added or deleted at any time at the station owner's discretion.

SATELLITE RADIO (If Equipped)

SIRIUS® broadcasts a variety of music, news, sports, weather, traffic and entertainment satellite radio channels. For more information and a complete list of SIRIUS satellite radio channels, visit www.siriusxm.com in the United States, www.sirius.ca in Canada, or call SIRIUS at 1-888-539-7474.

Audio System

Note: This receiver includes the eCos real-time operating system. eCos is published under the eCos License.

Satellite Radio Reception Factors

Potential satellite radio reception issues	
Antenna obstructions	For optimal reception performance, keep the antenna clear of snow and ice build-up and keep luggage and other material as far away from the antenna as possible.
Terrain	Hills, mountains, tall buildings, bridges, tunnels, freeway overpasses, parking garages, dense tree foliage and thunderstorms can interfere with your reception.
Station overload	When you pass a ground-based broadcast-repeating tower, a stronger signal may overtake a weaker one and the audio system may mute.
Satellite radio signal interference	Your display may show ACQUIRING . . . to indicate the interference and the audio system may mute.

SIRIUS® Satellite Radio Service

Note: SIRIUS reserves the unrestricted right to change, rearrange, add or delete programming including canceling, moving or adding particular channels, and its prices, at any time, with or without notice to you. Ford Motor Company shall not be responsible for any such programming changes.



E142593

SIRIUS satellite radio is a subscription-based satellite radio service that broadcasts a variety of music, sports, news, weather, traffic and entertainment programming. Your factory-installed SIRIUS satellite radio system includes hardware and a limited subscription term, which begins on the date of sale or lease of your vehicle. See an authorized dealer for availability.

For more information on extended subscription terms (a service fee is required), the online media player and a complete list of SIRIUS satellite radio channels, and other features, please visit www.siriusxm.com in the United States, www.sirius.ca in Canada, or call SIRIUS at 1-888-539-7474.

Audio System

Satellite Radio Electronic Serial Number (ESN)

You need your ESN to activate, modify or track your satellite radio account. When in

satellite radio mode, you can view this number by pressing **SIRIUS** and memory preset 1 at the same time, or tuning to channel 0.

Troubleshooting

Radio display	Condition	Possible action
Acquiring	Radio requires more than two seconds to produce audio for the selected channel.	No action required. This message should disappear shortly.
Sat Fault/SIRIUS system failure	There is an internal module or system failure present.	If this message does not clear shortly, or with an ignition key cycle, your receiver may have a fault. See an authorized dealer for service.
Invalid Channel	The channel is no longer available.	Tune to another channel or choose another preset.
Unsubscribed Channel	Your subscription does not include this channel.	Contact SIRIUS at 1-888-539-7474 to subscribe to the channel, or tune to another channel.
No Signal	The signal is lost from the SIRIUS satellite or SIRIUS tower to your vehicle antenna.	The signal is blocked. When you move into an open area, the signal should return.
Updating	Update of channel programming in progress.	No action required. The process may take up to three minutes.
Call SIRIUS 1-888-539-7474	Your satellite service is no longer available.	Contact SIRIUS at 1-888-539-7474 to resolve subscription issues.
None found. Check Channel Guide.	All the channels in the selected category are either skipped or locked.	Use the channel guide to turn off the Lock or Skip function on that station.
Subscription Updated	SIRIUS has updated the channels available for your vehicle.	No action required.

Audio System

AUDIO INPUT JACK

WARNINGS

 Driving while distracted can result in loss of vehicle control, crash and injury. We strongly recommend that you use extreme caution when using any device that may take your focus off the road. Your primary responsibility is the safe operation of your vehicle. We recommend against the use of any hand-held device while driving and encourage the use of voice-operated systems when possible. Make sure you are aware of all applicable local laws that may affect the use of electronic devices while driving.

 Do not connect or adjust the settings on your portable music player when your vehicle is moving.

 Do not place your portable music player on the instrument panel. Hard objects may become projectiles in a crash or sudden stop, which may increase the risk of serious injury.

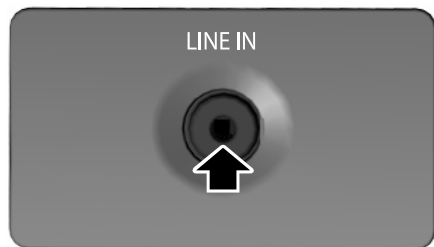

E191758

The audio input jack allows you to connect and play music from a portable music player through your vehicle speakers. You can use any portable music player designed for use with headphones.

Your audio extension cable must have male 1/8th-inch (3.5 millimeter) connectors at each end.

1. Switch off the engine, radio and portable music player. Set the parking brake and put the transmission in position **P**.
2. Plug the extension cable from the portable music player into the audio input jack.
3. Switch the radio on. Select either a tuned FM station or a CD.
4. Adjust the volume as desired.
5. Switch your portable music player on and adjust its volume to half its maximum level.
6. Press **AUX** or **MEDIA** until **LINE** or **LINE IN** appears in the display. You should hear music from your device even if it is low.
7. Adjust the volume on your portable music player until it reaches the volume level of the FM station or CD. Do this by switching back and forth between the AUX and FM or CD controls.

USB PORT (If Equipped)

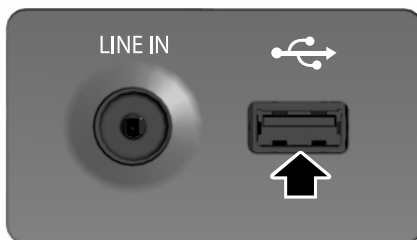

E191759

Audio System

The USB port allows you to plug in media playing devices, memory sticks and charge devices (if supported). See **SYNC™** (page 402).

MEDIA HUB (If Equipped)

The media hub is located in a compartment inside the center console.

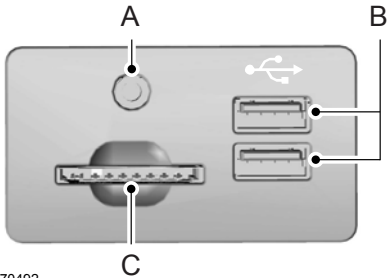

E170492

- A Line in
- B USB ports
- C SD card slot

See **Entertainment** (page 453).

GENERAL INFORMATION

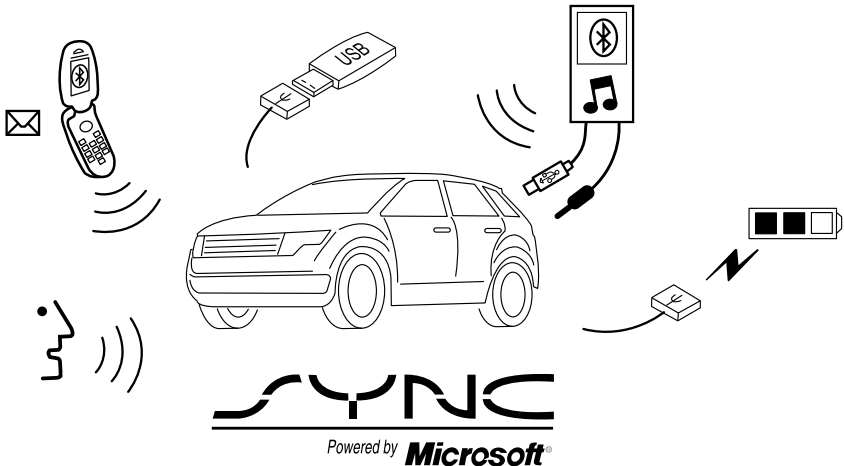

E142598

SYNC is an in-vehicle communications system that works with your Bluetooth-enabled cellular phone and portable media player. This allows you to:

- Make and receive calls.
- Access and play music from your portable music player.
- Use 911 Assist, Vehicle Health Report and SYNC Services (Traffic, Directions & Information).*
- Use applications, such as Pandora and Stitcher, via SYNC AppLink.**
- Access phonebook contacts and music using voice commands.
- Stream music from your connected phone.

- Text message.
- Use the advanced voice recognition system.
- Charge your USB device (if your device supports this).

*These features are not available in all markets and may require activation.

**Available AppLink enabled apps vary by market.

Make sure that you review your device's manual before using it with SYNC.

Support

The SYNC support team is available to help you with any questions you cannot answer on your own.

Monday–Saturday, 8:30am–9:00pm EST.
Sunday, 10:30am–7:30pm EST.
In the United States, call 1-800-392-3673.
In Canada, call 1-800-565-3673.

Times are subject to change due to holidays.

SYNC Owner Account

Why do I need a SYNC owner account?

- Required to activate Vehicle Health Report and to view the reports online.
- Required to activate the subscription-based SYNC Services and to personalize your Saved Points and Favorites.
- Essential for keeping up with the latest software downloads available for SYNC.
- Access to customer support for any questions you may have.

Driving Restrictions

For your safety, certain features are speed-dependent and restricted when your vehicle is traveling over 3 mi (5 km).

Safety Information

WARNING



Driving while distracted can result in loss of vehicle control, crash and injury. We strongly recommend that you use extreme caution when using any device that may take your focus off the road. Your primary responsibility is the safe operation of your vehicle. We recommend against the use of any hand-held device while driving and encourage the use of voice-operated systems when possible. Make sure you are aware of all applicable local laws that may affect the use of electronic devices while driving.

When using SYNC:

- Do not operate playing devices if the power cords or cables are broken, split or damaged. Place cords and cables out of the way, so they do not interfere with the operation of pedals, seats, compartments or safe driving abilities.
- Do not leave playing devices in your vehicle during extreme conditions as it could cause them damage. See your device's manual for further information.
- Do not attempt to service or repair the system. See an authorized dealer.

Privacy Information

When a cellular phone is connected to SYNC, the system creates a profile within your vehicle that is linked to that cellular phone. This profile is created in order to offer you more cellular features and to operate more efficiently. Among other things, this profile may contain data about your cellular phone book, text messages (read and unread), and call history, including history of calls when your cellular phone was not connected to the system. In addition, if you connect a media device, the system creates and retains an index of supported media content. The system also records a short development log of approximately 10 minutes of all recent system activity. The log profile and other system data may be used to improve the system and help diagnose any problems that may occur.

The cellular profile, media device index, and development log will remain in the vehicle unless you delete them and are generally accessible only in the vehicle when the cellular phone or media player is connected. If you no longer plan to use the system or the vehicle, we recommend you perform a Master Reset to erase all stored information.

System data cannot be accessed without special equipment and access to the vehicle's SYNC module. Ford Motor Company and Ford of Canada will not access the system data for any purpose other than as described absent consent, a court order, or where required by law enforcement, other government authorities, or other third parties acting with lawful authority. Other parties may seek to access the information independently of Ford Motor Company and Ford of Canada. For further privacy information, see the sections on 911 Assist, Vehicle Health Report, and Traffic, Directions and Information.

USING VOICE RECOGNITION

This system helps you control many features using voice commands. This allows you to keep your hands on the wheel and focus on what is around you.

Initiating a Voice Session



Press the voice button. A list of available voice commands appears in the display.

Global Voice Commands

These voice commands are always available. You can say them at any time.

Global voice commands	
"Cancel"	This command ends the voice session. You can also cancel a session by holding the voice button for two or more seconds.
"Help"	This command provides you with hints, examples and instructions.
"Main menu"	This command restarts the voice session from the initial starting point.

Helpful Hints

- Make sure the interior of your vehicle is as quiet as possible. Wind noise from open windows and road vibrations may prevent the system from correctly recognizing spoken commands.
- Before giving a voice command, wait for the system announcement to finish, followed by a single tone. Any command spoken before this does not register with the system.
- Speak naturally, without long pauses between words.
- You can interrupt the system at any time while it is speaking by pressing the voice button. You can cancel a voice session by pressing and holding the voice button.

System Interaction and Feedback

The system provides feedback through audible tones, prompts, questions and spoken confirmations depending on the situation and the chosen level of interaction. You can customize the voice recognition system to provide more or less instruction and feedback.

The default setting is to a higher level of interaction in order to help you learn to use the system. You can change these settings at any time.

Adjusting the Interaction Level



Press the voice button. When prompted, say "voice settings", then any of the following:

Command	The system:
"Interaction mode novice"	Provides more detailed interaction and guidance. (Recommended for first time users.)
"Interaction mode advanced"	Provides less audible interaction and guidance.

Confirmation Prompts

Confirmation prompts are short questions the system asks when it is not sure of your request or when there is more than one possible response to your request. For example, the system may ask if the command "Phone" is correct.

To adjust this setting, press the voice button. When prompted, say "voice settings", then any of the following:

Command	The system:
"Confirmation prompts off"	Makes a best guess from the command; you may still occasionally be asked to confirm settings.
"Confirmation prompts on"	Clarifies your voice command with a short question.

Candidate Lists

The system creates suggestion lists when it has the same confidence level of several options based on your voice commands. When switched on, the system may prompt you with as many as four possibilities for clarification.

You can switch this feature on or off by speaking one of the following voice commands:

Command	The system:
"Media candidate lists off"	Makes a best guess from the media candidate list. The system may still occasionally ask you questions.
"Media candidate lists on"	Clarifies your voice command for media candidates.
"Phone candidate lists off"	Makes a best guess from the phone candidate list. The system may still occasionally ask you questions.
"Phone candidate lists on"	Clarifies your voice command for phone candidates

Changing the Voice Settings

In addition to using voice commands to change the voice settings, you can also use the menu in the audio display.

1. Press the **MENU** button.
2. Select **SYNC-Settings**.
3. Select **Voice Settings**.

USING SYNC™ WITH YOUR PHONE

Hands-free calling is one of the main features of SYNC. While the system supports a variety of features, many are dependent on your cellular phone's functionality. At a minimum, most cellular phones with Bluetooth wireless technology support the following functions:

- Answering an incoming call.
- Ending a call.
- Using privacy mode.
- Dialing a number.
- Redialing.
- Call waiting notification.
- Caller ID.

Other features, such as text messaging using Bluetooth and automatic phonebook download, are phone-dependent features. To check your phone's compatibility, see your phone's manual and visit www.SYNCMYride.com, www.SYNCMYride.ca or www.syncmaroute.ca.

Pairing a Phone for the First Time

Wirelessly pairing your phone with SYNC allows you to make and receive hands-free calls.

Note: SYNC can support downloading up to approximately 4000 entries per Bluetooth-enabled cellular phone.

Note: Make sure to switch on the ignition and the radio. Put the transmission in park (P).

Using the Audio System

Note: To scroll through the menus, press the up and down arrows on your audio system.

1. Make sure to switch on your phone's Bluetooth feature before starting the search. See your device's manual if necessary.
2. Press the **PHONE** button. When the audio display indicates there is no paired phone, select the option to add.
3. When a message to begin pairing appears in the audio display, search for SYNC on your phone to start the pairing process.
4. When prompted on your phone's display, enter the six-digit PIN provided by the system in the radio display. The display indicates when the pairing is successful.

Depending on your phone's capability and your market, the system may prompt you with questions, such as setting the current phone as the primary phone (the phone SYNC automatically tries to connect with first upon vehicle start-up) and downloading your phonebook.

Using Voice Commands



1. Make sure to switch on your phone's Bluetooth feature before starting the search. See your device's manual if necessary.
2. Start a voice session, and then say "Pair device".
3. Follow the instructions on the audio display.

Depending on your phone's capability and your market, the system may prompt you with questions, such as setting the current phone as the primary phone (the phone SYNC automatically tries to connect with first upon vehicle start-up) and downloading your phonebook.

Pairing Subsequent Phones

Note: Make sure to switch on the ignition and the radio. Put the transmission in park (P).

Note: To scroll through the menus, press the up and down arrows on your audio system.

1. Make sure to switch on your phone's Bluetooth feature before starting the search. See your device's manual if necessary.
2. Press the **PHONE** button.
3. Select the option for Bluetooth Devices.
4. Press the **OK** button.
5. Select the option to add. This starts the pairing process.
6. When a message to begin pairing appears in the audio display, search for SYNC on your device.
7. When prompted on your phone's display, enter the six-digit PIN provided by the system in the audio display. The display indicates when the pairing is successful.

Depending on your phone's capability and your market, the system may prompt you with questions, such as setting the current phone as the primary phone (the phone SYNC automatically tries to connect with first upon vehicle start-up) and downloading your phonebook.

Phone Voice Commands



Press the voice button. When prompted, say any of the following:

"PHONE"
"Call <name>"
"Call <name> at home"
"Call <name> at work"
"Call <name> on cell"
"Call <name> on other"
"Dial" ¹
"Go to handsfree" ¹²
"Hold call <on> <off>" ²
"Join calls" ²
"Messages" ¹³
"Mute call" ¹²
"Phone help"
"Privacy on" ¹²
"Turn ringer <on> <off>"
"Unmute call" ¹²

¹ See **Dial** table below.

² These commands are only valid while in a phone call.

³ See **Messages** table below.

Phone book commands: When you ask SYNC to access things such as a phonebook name or number, the requested information appears in the display to view. Press the phone button and say, "Call" to call the contact.

"DIAL"
"411 (four-one-one)", "911" (nine-one-one)
"700" (seven hundred)
"800" (eight hundred)
"900" (nine hundred)
"Clear" (deletes all entered digits)
"Delete" (deletes last set of digits entered)
"Number <0-9>"
"Plus"
"Pound" (#)
"Star" (*)

Note: To exit dial mode, press and hold the phone button or press any button on the audio system.

"MESSAGES"
"Listen to text message <#>"
"Forward text message"
"Reply to text message"
"Call sender"

Making Calls



Press the voice button. When prompted, say:

1. Say "Call <name>" or "Dial", then the desired number.
2. When the system confirms the number, say, "Dial" again to initiate the call.

To erase the last spoken digit, say, "Delete". To erase all spoken digits, say, "Clear".

To end the call, press the end call button on the steering wheel or select the end call option in the audio display.

Receiving Calls

When receiving a call, you can:

- Answer the call by pressing the accept call button on the steering wheel or by selecting the accept call option in the audio display.
- Reject the call by pressing the reject call button on the steering wheel or by selecting the reject call option in the audio display.
- Ignore the call by doing nothing.

Phone Options during an Active Call

During an active call, you have more menu features that become available, such as putting a call on hold or joining calls.

To access this menu, choose one of the options available at the bottom of the audio display or select **More** to choose from the following options:

Display	Description and action
Mic. off	Turn your vehicle's microphone off. To turn the microphone on, select the option again.
Privacy	Switch a call from an active hands-free environment to your cellular phone for a more private conversation. When selected, the audio display indicates the call is private.
Hold	Put an active call on hold. When selected, the audio display indicates the call is on hold.
Dial a number	Enter numbers using the audio system's numeric keypad (for example, numbers for passwords).
Join calls	Join two separate calls. The system supports a maximum of three callers on a multiparty or conference call. 1. Select the More option. 2. Access the desired contact through the system or use voice commands to place the second call. Once actively in the second call, select the More option. 3. Scroll to the option to join calls and press the OK button.
Phonebook	Access your phonebook contacts. 1. Select the More option. 2. Scroll to the option for phonebook and press the OK button. 3. Scroll through your phonebook contacts. 4. Press the OK button again when the desired contact appears in the audio display. 5. Press the OK button or dial button to call the selection.
Call history	Access your call history log. 1. Select the More option. 2. Scroll to the option for call history and press the OK button. 3. Scroll through your call history options (incoming, outgoing or missed). 4. Press the OK button again when the desired selection appears in the audio display. 5. Press the OK button or dial button to call the selection.

Accessing Features through the Phone Menu

You can access your call history, phonebook, sent text messages, as well as access phone and system settings.

1. Press the **PHONE** button to enter the phone menu.
2. Select one of the options available

Display	Description and action
Dial a number	Enter numbers using the audio system's numeric keypad.
Phonebook	Access your downloaded phonebook. 1. Press the OK button to confirm and enter. You can use the options at the bottom of the screen to access an alphabetical category quickly. You can also use the letters on the audio system's numeric keypad to jump in the list. 2. Scroll through your phonebook contacts. 3. Press the OK button again when the desired selection appears in the audio display. 4. Press the OK button or dial button to call the selection.
Call history	Access any previously dialed, received or missed calls. 1. Press the OK button to select. 2. Scroll to select incoming, outgoing or missed calls. Press the OK button to make your selection. 3. Press the OK button or dial button to call the selection.
Speed dial	Select 1 of 10 speed dial entries. To set a speed dial entry, go to the phonebook and then press and hold one of the numbers on the audio system's numeric keypad.
Text messaging	Send, download and delete text messages.
BT devices	Access the option for Bluetooth Device menu listings (add, connect, set as primary, on or off, delete).
Phone settings	View various settings and features on your phone.

Text Messaging

Note: *This is a phone-dependent feature.*

SYNC allows you to receive, send, download and delete text messages. The system can also read incoming text messages to you so that you do not have to take your eyes off the road.

Receiving a Text Message

Note: *This is a phone-dependent feature. Your phone must support downloading text messages using Bluetooth to receive incoming text messages.*

Note: *This is a speed-dependent feature and is only available when your vehicle is traveling at 3 mph (5 km/h) or less.*

When a new message arrives, an audible tone sounds and the audio display indicates you have a new message.

You have these options:

- Press the voice button and say, "Read message".
- Select the listen option to have the system read the message to you.
- Select the ignore option, or do nothing, and the message goes into your text message inbox.

- Select the view option to open the text message. Once selected, you have the ability to have the message read to you, to view other messages, or to select the **More** option.
- If you select the **More** option, use the arrow button to scroll through the following options:

Display	Description and action
Reply to sender	Press the OK button to access, and then scroll through a list of pre-defined messages to send.
Call sender	Press the OK button to call the sender of the message.
Forward msg.	Press the OK button to forward the message to anyone in your phonebook or call history. You can also choose to enter a number.

Sending, Downloading and Deleting Your Text Messages

1. Press the **PHONE** button.

2. Select the text messaging option, and then press the **OK** button.

Choose from the following options:

Display	Description and action
New	Allows you to send a new text message based on a pre-defined set of 15 messages.
View	Allows you to read the full message and, in addition, provides the option to have the system read the message to you. To go to the next message, select the More option. This allows you to reply to the sender, call the sender or forward the message.
Delete	Allows you to delete current text messages from the system (not your cellular phone). The audio display indicates when the system has deleted all your text messages.
More...	Allows you to delete all messages or manually trigger a download of all unread messages from your cellular phone.

Sending a Text Message

Note: You can only send a text message to one recipient at a time.

1. Select the send option when the desired selection highlights in the audio display.
2. Select the confirmation option when the contact appears.
3. Press the OK button again to confirm when the system asks if you want to send the message. A pre-defined signature appears on each text message.

Note: You can send text messages either by choosing a contact from the phonebook and selecting the text option from the audio display or by replying to a received message in the inbox.

Accessing Your Phone Settings

These are phone-dependent features. Your phone settings allow you to access and adjust features such as your ring tone, text message notification, modify your phonebook and set up automatic download.

1. Press the **PHONE** button.
2. Scroll until the phone settings option appears, and then press the **OK** button.
3. Scroll to select from the following options:

Display	Description and action
Set as master	If this option is checked, the system uses the cellular phone as the master when there is more than one cellular phone paired to the system. This option can be changed for all cellular phones (not only the active phone) using the Bluetooth Devices menu.
Phone status	See the cellular phone name, provider name, cellular phone number, and signal level. When done, press the left arrow buttons to return to the phone status menu.
Set ringtone	Select which ringtone sounds during an incoming call (one of the system's tones or your cellular phone's). If your phone supports in-band ringing, your phone's ringtone sounds when you choose the cellular phone ringtone option. 1. Press the OK button to select and scroll to hear each ringtone.

Display	Description and action
	2. Press the OK button to select a ringtone.
Text msg notify	Have the option of hearing an audible tone to notify you when a text message arrives. Press the OK button to turn the audible tone off or on.
Phonebook pref.	Modify the contents of your phonebook (such as add, delete or download). Press the OK button to select and scroll between the choices in the phonebook preferences table below.

Phonebook preferences	
Add contacts	Push the desired contacts on your cellular phone. See your device's manual on how to push contacts. Press the OK button to add more contacts from your phonebook.
Delete	When a message asking you to delete appears, select the option to confirm. Press the OK button to delete the current phonebook and call history. The system takes you back to the menu for phone settings.
Download now	Press the OK button to select and download your phonebook to the system.
Auto-download	When automatic download is on, the system deletes any changes (additions or deletions) saved in the system since your last download.
	When automatic download is off, the system does not download your phonebook when your cellular phone connects to SYNC.
	You can only access your phonebook, call history and text messages when your paired cellular phone connects to the system. Check or uncheck this option to download your phonebook automatically each time your phone connects to the system. Download times are phone-dependent and quantity-dependent.

Bluetooth Devices

The Bluetooth Devices menu allows you to add, connect and delete devices as well as set a phone as primary.

1. Press the **PHONE** button.
2. Scroll until Bluetooth Devices appears, and then press the **OK** button.
3. Select from the following options:

Phonebook preferences	
Add	<p>Pair additional phones to the system.</p> <ol style="list-style-type: none"> 1. Select the option to add to start the pairing process. 2. When a message to begin pairing appears in the audio display, search for SYNC on your phone. See your phone's manual if necessary. 3. When prompted on your phone's display, enter the six-digit PIN provided by the system in the radio display. The display indicates when the pairing is successful. 4. When the option to set the phone as primary appears, select either yes or no. 5. Depending on the functionality of your phone, the system may prompt you with questions (such as if you want to download your phonebook). Select either yes or no to confirm your responses.
Delete	<p>Select the delete option and confirm when the system asks to delete the selected device. After deleting a phone from the list, you have to repeat the pairing process to pair it again.</p>
Master	<p>The system attempts to connect with the primary cellular phone each time you switch on the ignition. When you select a cellular phone as primary, it appears first in the list, marked with an asterisk. Set a previously paired phone as master by selecting the master option and confirming it as the primary.</p>
Conn.	<p>Connect a previously connected phone. You can only have one phone connected at a time to use the phone's functionality. When you connect another phone, the previous phone disconnects from the telephone services. The system allows you to use different Bluetooth devices for the cellular phone functionality and the Bluetooth audio music playback feature at the same time.</p>
Discon.	<p>Disconnects the selected cellular phone. Select this option and confirm when asked. After disconnecting a phone, you can reconnect it again without repeating the full pairing process.</p>

System Settings

1. Press the **MENU** button.
2. Select the SYNC settings option, and then press the **OK** button.
3. Scroll to select from the following options:

Display	Description and action
Bluetooth on	Check or uncheck this option to switch the system's Bluetooth interface off or on. Select this option, and then press the OK button to change the option's status.
Set defaults	Return to the factory default settings without erasing your indexed information (such as phonebook, call history, text messages and paired devices). Select this option and confirm when prompted in the audio display.
Master reset	Completely erase all information stored in the system (such as phonebook, call history, text messages and paired devices) and return to factory default settings.
Install on SYNC	Install downloaded applications or software updates. Select this option and confirm when prompted in the audio display. There must be a valid SYNC application or update available on the USB drive in order to finish an installation successfully.
System info	Display the system's version numbers as well as its serial number. Press the OK button to select.
Voice settings	The voice settings submenu contains various options. See Using Voice Recognition (page 404).
Browse USB	Browse the actual menu structure of the connected USB device. Press the OK button and use the up and down arrow buttons to scroll through the folders and files. Use the left or right arrow buttons to enter or leave a folder. You can select media content for playback from this menu.

SYNC™ APPLICATIONS AND SERVICES (If Equipped)

In order for the following features to work, your cellular phone must be compatible with SYNC. To check your phone's compatibility, visit www.SYNCMyRide.com, www.SYNCMyRide.ca or www.syncmaroute.ca.

- 911 Assist: Can alert 911 in the event of an emergency.
- SYNC AppLink: Allows you to connect to and use certain applications such as Pandora and Stitcher (if your phone is compatible).

These features may require activation. Available AppLink enabled apps varies by market.

911 Assist (If Equipped)

WARNINGS



Unless the 911 Assist setting is set on before a crash, the system will not dial for help which could delay response time, potentially increasing the risk of serious injury or death after a crash.



Do not wait for 911 Assist to make an emergency call if you can do it yourself. Dial emergency services immediately to avoid delayed response time which could increase the risk of serious injury or death after a crash. If you do not hear 911 Assist within five seconds of the crash, the system or phone may be damaged or non-functional.



Always place your phone in a secure location in your vehicle so it does not become a projectile or get damaged in a crash. Failure to do so may cause serious injury to someone or damage the phone which could prevent 911 Assist from working properly.

Note: The SYNC 911 Assist feature must be set on before the incident.

Note: Before setting this feature on, make sure that you read the 911 Assist Privacy Notice later in this section for important information.

Note: If any user turns 911 Assist on or off, that setting applies for all paired phones. If 911 Assist is turned off, either a voice message plays or a display message (or icon) comes on (or both) when your vehicle is started after a previously paired phone connects.

Note: Every phone operates differently. While SYNC 911 Assist works with most cellular phones, some may have trouble using this feature.

If a crash deploys an airbag (excluding knee airbags and rear inflatable safety belts [if equipped]) or activates the fuel pump shut-off, your SYNC-equipped vehicle may be able to contact emergency services by dialing 911 through a paired and connected Bluetooth-enabled phone. You can learn more about the 911 Assist feature, visit www.SYNCMyRide.com, www.SYNCMyRide.ca or www.syncmaroute.ca.

See **Supplementary Restraints System** (page 43). Important information about airbag deployment is in this chapter.

See **Roadside Emergencies** (page 277). Important information about the fuel pump shut-off is in this chapter.

Switching 911 Assist On or Off

1. Press the phone button to enter the phone menu.
2. Scroll to select 911 Assist.
3. Press **OK** to confirm and enter the 911 Assist menu.
4. Scroll to select between On or Off.

5. Press **OK** when the desired option appears in the radio display. **Set On** or **Set Off** appears in the display as confirmation.

Off selections include:

- Off with reminder: Provides a display and voice reminder at phone connection at vehicle start.
- Off without reminder: Provides a display reminder only without a voice reminder at phone connection.

To make sure that 911 Assist works correctly:

- SYNC must be powered and working properly at the time of the incident and throughout feature activation and use.
- The 911 Assist feature must be set on before the incident.
- You must pair and connect a Bluetooth-enabled and compatible cell phone to SYNC.
- A connected Bluetooth-enabled phone must have the ability to make and maintain an outgoing call at the time of the incident.
- A connected Bluetooth-enabled phone must have adequate network coverage, battery power and signal strength.
- The vehicle must have battery power and be located in the U.S., Canada or in a territory in which 911 is the emergency number.

In the Event of a Crash

Not all crashes will deploy an airbag or activate the fuel pump shut-off (the triggers for 911 Assist). If a connected cell phone sustains damage or loses its connection to SYNC during a crash, SYNC will search for and try to connect to a previously paired cell phone; SYNC will then attempt to call the emergency services.

Before making the call:

- SYNC provides a short window of time (about 10 seconds) to cancel the call. If you fail to cancel the call, SYNC attempts to dial 911.
- SYNC says the following, or a similar message: "SYNC will attempt to call 911, to cancel the call, press Cancel on your screen or press and hold the phone button on your steering wheel."

If you do not cancel the call, and SYNC makes a successful call, a pre-recorded message plays for the 911 operator, and then the occupant(s) in your vehicle is able to talk with the operator. Be prepared to provide your name, phone number and location immediately, because not all 911 systems are capable of receiving this information electronically.

911 Assist May Not Work If

- Your cellular phone or 911 Assist hardware sustains damage in a crash.
- The vehicle's battery or the SYNC system has no power.
- The phone(s) previously paired or connected to the system are thrown from the vehicle

911 Assist Privacy Notice

When you turn on 911 Assist, it may disclose to emergency services that your vehicle has been in a crash involving the deployment of an airbag or activation of the fuel pump shut-off. Certain versions or updates to 911 Assist may also be capable of electronically or verbally disclosing to 911 operators your vehicle location or other details about your vehicle or crash to assist 911 operators to provide the most appropriate emergency services. If you do not want to disclose this information, do not turn the feature on.

SYNC Mobile Apps

The system enables voice and steering wheel control of SYNC AppLink enabled smartphone apps. Once an app is running through AppLink, you can control main features of the app through voice commands and steering wheel controls.

Note: You must pair and connect your smartphone to SYNC to access AppLink.

Note: iPhone users need to connect the phone to the USB port.

Note: Android users need to connect the phone to SYNC using Bluetooth.

Note: For information on available apps, supported smartphone devices and troubleshooting tips please visit the Ford website.

Note: Make sure you have an active account for the app that you have downloaded. Some apps work automatically with no setup. Other apps want you to configure your personal settings and personalize your experience by creating stations or favorites. We recommend you do this at home or outside of your vehicle.

Note: AppLink is not available if your vehicle is equipped with the MyFordTouch system.

To Access Using the SYNC Menu

1. Press the **MENU** button to access the menu on-screen.
2. Select **SyncApplications**.
3. Select **Mobile Apps**.
4. Scroll through the list of available applications and select a particular app or select **Find New Apps**.

Note: If a SYNC AppLink compatible app cannot be found, make sure the required app is running on the mobile device.

Accessing an App's Menu

Once an app is running through SYNC, press the right arrow button on the steering wheel control to access the app menu.

You can access various app features from here, for example thumbs up and thumbs down.

Press the left arrow button on the steering wheel control to exit the app menu.

To Access Using Voice Commands

1. Press the voice icon.
2. When prompted, say "Mobile Apps".
3. Say the name of the application after the tone.
4. The app should start. While an app is running through SYNC, you can press the voice button and speak commands specific to the app, for example "Play Playlist Road Trip". Say, "Help" to discover the available voice commands.

SYNC Mobile App Voice Commands

The following voice commands are always available:

- "Mobile apps": SYNC prompts you to say the name of an app to start it on SYNC.
- "List mobile apps": SYNC lists all of the currently available mobile apps.
- "Find new apps": searches your connected mobile device for SYNC-compatible mobile apps.
- "<the name of an app>": At any time you can say the name of a mobile app to start the mobile app on SYNC.
- "<the name of an app> help": SYNC lists the available voice commands for the specified app if the app is running on SYNC.

App Permissions

App permissions are organized by groups. You can grant these group permissions individually. You can change a permission group status any time when not driving, by using the settings menu.

When you launch an app using SYNC, the system may ask you to grant certain permissions, for example:

- To allow your vehicle to provide vehicle information to the app such as, but not limited to: Fuel level, fuel economy, fuel consumption, engine speed, rain sensor, odometer, VIN, external temperature, gear position, tire pressure, and head lamp status.
- To allow your vehicle to provide driving characteristic information such as, but not limited to: MyKey, seat belt status, engine revolutions per minute, gear position, braking events, steering wheel angle, and accelerator pedal position.
- To allow your vehicle to provide location information, including: GPS and speed.
- To allow the app to send push notifications using the vehicle display and voice capabilities while running in a background state. Push notifications may be particularly useful for news or location based apps.

Note: *You only need to grant permissions the first time you use an app with SYNC.*

Note: *Ford is not responsible or liable for any damages or loss of privacy relating to usage of an app, or dissemination of any vehicle data that you approve Ford to provide to an app.*

Enabling and Disabling App Permissions Using the SYNC Menu

1. Press the **MENU** button to access the SYNC menu.
2. Select **SyncApplications > Mobile Apps > App Settings**.
3. Select the specific app or **All Apps**.
4. If push notifications are supported, this setting is listed. Select to enable or disable the feature as required.

Enabling SYNC Mobile Apps

In order to enable mobile apps, SYNC requires user consent to send and receive app authorization information and updates using the data plan associated with the connected device.

Data is sent to Ford in the United States through the connected device. The information is encrypted and includes your VIN, SYNC module number, anonymous usage statistics and debugging information. Updates may take place automatically.

Note: *You must enable mobile apps for each connected device the first time you select a mobile app using the system.*

Note: *Standard data rates apply. Ford is not responsible for any additional charges you may receive from your service provider, when your vehicle sends or receives data through the connected device. This includes any additional charges incurred due to driving in areas when roaming out of a home network.*

App Status

You can view the current status of an app in the settings menu.

There are three possible statuses:

- **Update Needed:** The system has detected a new app requiring authorization or a general permissions update is required.
- **Up-To-Date:** No update is required.
- **Updating:** The system is trying to receive an update.

If an update is required and you want to request this update manually, for example when in a Wi-Fi hotspot, select **Request Update** in the settings menu.

You can disable automatic updates by selecting **Disable Updates** in the settings menu. Doing so also disables the use of Mobile Apps on SYNC.

USING SYNC™ WITH YOUR MEDIA PLAYER

You can access and play music from your digital music player over your vehicle's speaker system using the system's media menu or voice commands. You can also sort and play your music by specific categories, such as artist and album.

Note: *The system is capable of indexing up to 15,000 songs.*

SYNC is capable of hosting nearly any digital media player including: iPod, Zune, plays from device players, and most USB drives. SYNC also supports audio formats, such as MP3, WMA, WAV and ACC.

Connecting Your Digital Media Player to the USB Port

Note: *If your digital media player has a power switch, make sure you switch it on before plugging it in.*

Using Voice Commands

1. Plug the device into your vehicle's USB port.
2. Press the voice button and when prompted, say "USB" or "iPod".

3. You can now play music by saying any of the appropriate voice commands. See the media voice commands.

Using the System Menu

1. Plug the device into your vehicle's USB port.
2. Press the **AUX** button until an "initializing" message appears in the display. Depending on how many media files are on your connected device, an indexing message may appear in the display. When indexing is complete, the screen returns to the playback menu.

You can browse the files on the USB device in categories. Choose from the following:

- Play all
- Playlists
- Songs
- Artists
- Albums
- Genres
- Browse USB
- Reset USB

What's Playing?

At any time during playback, you can press the voice button and ask the system what is playing. The system reads the metadata tags (if populated) of the current track.

Media Voice Commands



Press the voice button. When prompted, say "USB" or "iPod", and then any of the following:

Command	Description and action
"Pause"	Pauses device playback.
"Play"	Resumes device playback.
"Play album <album name>"	Commands inside the "< >" are dynamic, which means it could be the name of anything such as album, artist or song. This voice command is not available until indexing is complete on your device.
"Play all"	Play all media on the device from the first track to the last.
"Play artist <artist name>"	Commands inside the "< >" are dynamic, which means it could be the name of anything such as album, artist or song. This voice command is not available until indexing is complete on your device.
"Play genre <genre name>"	Commands inside the "< >" are dynamic, which means it could be the name of anything such as album, artist or song. This voice command is not available until indexing is complete on your device.
"Play playlist <playlist name>"	Commands inside the "< >" are dynamic, which means it could be the name of anything such as album, artist or song. This voice command is not available until indexing is complete on your device.
"Play next track"	Plays the next track on the current media.
"Play previous track"	Plays the previous track on current media.
"Play similar music"	Creates a playplan of similar genre to the one currently playing.
"Play song <song name>"	Commands inside the "< >" are dynamic, which means it could be the name of anything such as album, artist or song. This voice command is not available until indexing is complete on your device.
"Repeat off"	
"Repeat one"	Repeats the current track.
"Shuffle all"	Plays the current playplan in a random order. (Not all devices support this command.)
"Shuffle off"	
"What's playing?" or "What's this?"	

Examples of USB Commands

SYNC provides the user with many intuitive ways to find and play a song using voice. For example, if we have a song called "Penny Lane" from the album "Magical Mystery Tour" we can say the following to play this song:

- Play song "Penny Lane".
- Play "Penny Lane".

If we wanted to play the entire album, we can say:

- Play album "Magical Mystery Tour".
- Play "Magical Mystery Tour".

Bluetooth Audio

The system is also capable of playing music from your cellular phone through Bluetooth.

To switch on Bluetooth audio, use the **AUX** or **SOURCE** button. You can also press the voice button and, when prompted, say, "Bluetooth audio".

"BLUETOOTH AUDIO"
"Pause"
"Play"
"Play next track"
"Play previous track"

Media Menu Features

The media menu allows you to select how to play your music (such as by artist, genre, shuffle or repeat), find similar music or reset the index of your USB devices.

1. Press **AUX** to select USB playback.
2. Select Options to enter the media menu, and then any of the following:

Display	Description and action
Shuffle	Choose to have the system play your music in random order. Once you make your choice, it remains on until you switch it off.
Repeat track	Choose to have the system repeat the current track. Once you make your choice, it remains on until you switch it off.
Similar music	You can play music similar to the current type of music in the playlist. The system uses metadata information of each track to compile a playlist, creates a new list of similar tracks, and then begins playing that list. (Each track must have populated metadata tags for this feature.)
	With some devices, unpopulated metadata tags make the tracks unavailable for voice recognition, play menu or this option. However, if you place these tracks onto your playing device in mass storage device mode, they are available for voice recognition, play menu and this option. The system places unknowns into any unpopulated metadata tag.
Reset SYNC USB	Resets the USB index. After the new indexing is complete, you can choose what to play from the USB song library.

Accessing Your USB Song Library

Using Voice Commands

You can access and view your USB songs using voice commands.

1. Plug the device into your vehicle's USB port.
2. Press the voice button and when prompted, say any of the following commands:

Accessing and viewing USB media
"Browse all albums"
"Browse all artists"
"Browse all genres"
"Browse all playlists"

Accessing and viewing USB media

"Browse all songs"
"Browse album <name>"
"Browse artist <name>"
"Browse genre <name>"
"Browse playlist <name>"

Using the System Menu

1. Plug the device into your vehicle's USB port.
2. Press the **AUX** button to select USB playback.

3. Select Browse USB. If there are no media files to access, the display indicates there is no media. If there are media files, you have the following options:

Display	Description and action
Play all	Play all indexed media files from your device one at a time in numerical order.* Press the OK button to select. The first track title appears in the display.
Playlists	Access your playlists (from formats like ASX, M3U, WPL, or MTP).* 1. Press the OK button to select. 2. Scroll to select the desired playlist, and then press the OK button.
Songs	Search for and play a specific indexed track.* 1. Press the OK button to select. 2. Scroll to select the desired track, and then press the OK button.
Artists	Sort all indexed media files by artist. The system then lists and plays all artists and tracks alphabetically.* 1. Press the OK button to select. 2. Scroll to select the desired artist, and then press the OK button.
Albums	Sort all indexed media files by album.* 1. Press the OK button to select. 2. Scroll to select the desired album, and then press the OK button.
Genres	Sort all indexed media files by genre (category) type.* 1. Press the OK button to select. 2. Scroll to select the desired genre, and then press the OK button.
Browse USB	Browse all supported media files on your media player connected to the USB port. You can only view media files that are compatible with SYNC. (Other files are not visible.) 1. Press the OK button to select.

Display	Description and action
	2. Scroll to browse indexed media files on the device, and then press the OK button.
Reset USB	Resets the USB index. After the new indexing is complete, you can choose what to play from the USB song library.

*You can use the buttons at the bottom of the audio display to jump to a certain alphabetical category quickly. You can also use the letters on the audio system's numeric keypad to jump in the list.

USB 2 (If Equipped)

Your vehicle may come equipped with an additional USB port. If so, USB 1 will be located at the front of the vehicle at the bottom of the instrument panel. USB 2 will be located inside the storage compartment of the vehicle's center console.

You can plug in an additional USB device into the second USB port. To switch between the two connected USB devices using voice commands, say, "USB1" or "USB2". Saying "USB" defaults to the most recently played USB device.

Note: SYNC only supports one connected iOS (Apple) devices at a time (whichever one you plug in first). When you connect a second iOS device, the systems charges it, but does not support playback from it.

Line In Audio

To access the Line In audio source, start a voice session and say, "Line in" or "Aux".

Bluetooth Devices and System Settings

You can access these menus using the audio display. See **Using SYNC™ With Your Phone** (page 406).

Voice Commands for Audio Sources

Your voice system allows you to change audio sources with a simple voice command.



Press the voice button and say, "Audio" when prompted, and then any of the following commands:

"AUDIO"
"AM"
"AM1"
"AM autose" or "AM2"
"Bluetooth <audio> <stereo>"
"CD"
"FM"
"FM1"
"FM autose" or "FM2"
"Line in"
"Radio"
"SAT <1-3>"
"Sirius"

"AUDIO"
"USB"
"What's playing"
"Help"

Radio Voice Commands



If you are listening to the radio, press the voice button, and then any of the commands in the following table. If you are not listening to the radio, press the voice button and, after the tone, say, "Radio", and then any of the following voice commands:

"RADIO"
"AM"
"AM1"
"AM autosest" or "AM2"
"AM <530-1710>"
"AM preset <number>"
"AM [1] [autosest] preset <number>"
"FM"
"FM1"
"FM autosest" or "FM2"
"FM <87.9-107.9>"
"FM [autosest] preset <number>"
"FM <radio frequency> HD <1-7>"
"FM1 preset <number>"
"FM2 preset <number>"
"HD <1-7>"

"RADIO"
"Preset <number>"
"Tune"
"Help"

Sirius Satellite Radio Voice Commands



If you are listening to Sirius satellite radio, press the voice button, and then any of the commands in the following table. If you are not listening to Sirius satellite radio, press the voice button and, after the tone, say, "Sirius", and then any of the following voice commands:

"SIRIUS"
"<0-233>"
"SAT"
"SAT1"
"SAT2"
"SAT3"
"Preset <number>"
"SAT1 preset <number>"
"SAT2 preset <number>"
"SAT3 preset <number>"
"Tune"
"Help"

CD Voice Commands



If you are listening to a CD, press the voice button, and then any of the commands in the following table. If you are not listening to a CD, press the voice button and, after the tone, say, "CD", and then any of the following voice commands:

"CD"
"Pause"
"Play"
"Play next track"
"Play previous track"
"Play track <1-512>"
"Repeat"
"Repeat folder"
"Repeat off"
"Repeat track"

"CD"
"Shuffle"
"Shuffle CD"
"Shuffle folder"
"Shuffle off"

*You need to indicate to the system which track or folder to repeat or shuffle when using these commands.

SYNC™ TROUBLESHOOTING

Your SYNC system is easy to use. However, should questions arise, see the tables below.

Use the website at any time to check your phone's compatibility, register your account and set preferences as well as access a customer representative via an online chat (during certain hours). Visit www.SYNCMyRide.com, www.SYNCMyRide.ca or www.syncmaroute.ca for more information.

Phone issues		
Issue	Possible cause(s)	Possible solution(s)
There is excessive background noise during a phone call.	The audio control settings on your phone may be affecting SYNC performance.	Review your phone's manual about audio adjustments.
During a call, I can hear the other person but they cannot hear me.	This may be a possible phone malfunction.	Try turning off the device, resetting the device, removing the device's battery, then trying again.
SYNC is not able to download my phonebook.	This is a phone-dependent feature.	Go to the website to review your phone's compatibility.

SYNC™

Phone issues		
Issue	Possible cause(s)	Possible solution(s)
	This may be a possible phone malfunction.	<p>Try turning off the device, resetting the device or removing the device's battery, then trying again.</p> <p>Try pushing your phonebook contacts to SYNC by using the Add Contacts feature.</p> <p>Use the SYNCmyphone feature available on the website.</p>
The system says Phonebook Downloaded but the phonebook in SYNC is empty or missing contacts.	This may be a limitation on your phone's capability.	<p>Try pushing your phonebook contacts to SYNC by using the Add Contacts feature.</p> <p>If the missing contacts are stored on your SIM card, try moving them to the device memory.</p> <p>Remove any pictures or special ring tones associated with the missing contact.</p> <p>Depending upon your phone, you may have to grant SYNC permission to access your phonebook contacts. Make sure to confirm when prompted by your phone during the phonebook download.</p>
I am having trouble connecting my phone to SYNC.	This is a phone-dependent feature.	<p>Go to the website to review your phone's compatibility.</p> <p>Try turning off the device, resetting the device or removing the device's battery, then trying again.</p>

SYNC™

Phone issues		
Issue	Possible cause(s)	Possible solution(s)
	This may be a possible phone malfunction.	<p>Try deleting your device from SYNC, deleting SYNC from your device and trying again.</p> <p>Check the security and auto accept and prompt always settings relative to the SYNC Bluetooth connection on your phone.</p> <p>Update your device's firm-ware.</p> <p>Turn off the Auto phone-book download setting.</p>
Text messaging is not working on SYNC.	<p>This is a phone-dependent feature.</p> <p>This may be a possible phone malfunction.</p>	<p>Go to the website to review your phone's compatibility.</p> <p>Try turning off the device, resetting the device or removing the device's battery, then trying again.</p>

USB and media issues		
Issue	Possible cause(s)	Possible solution(s)
I am having trouble connecting my device.	This may be a possible device malfunction.	<p>Try turning off the device, resetting the device, removing the device's battery, then trying again.</p> <p>Make sure you are using the manufacturer's cable.</p> <p>Make sure you insert the USB cable correctly into the device and the USB port.</p> <p>Make sure that the device does not have an auto-install program or active security settings.</p>

SYNC™

USB and media issues		
Issue	Possible cause(s)	Possible solution(s)
SYNC does not recognize my device when I turn on the car.	This is a device limitation.	Make sure you are not leaving the device in your vehicle during very hot or cold temperatures.
Bluetooth audio does not stream.	This is a phone-dependent feature. The device is not connected.	Review the device compatibility chart on the SYNC website to confirm your phone supports the Bluetooth audio streaming function. Make sure you correctly connect the device to SYNC, and that you have pressed play on your device.
SYNC does not recognize music that is on my device.	Your music files may not contain the correct artist, song title, album or genre information. The file may be corrupted. The song may have copy-right protection, which does not allow it to play.	Make sure that all song details are populated. Some devices require you to change the USB settings from mass storage to MTP class.

Voice command issues		
Issue	Possible cause(s)	Possible solution(s)
SYNC does not understand what I am saying.	<p>You may be using the wrong voice commands.</p> <p>You may be speaking too soon or at the wrong time.</p>	<p>Review the phone voice commands and the media voice commands at the beginning of their respective sections.</p> <p>After pressing the voice icon, wait until after the tone sounds and Listening appears before saying a command. Any command spoken before this does not register with the system.</p>
SYNC does not understand the name of a song or artist.	<p>You may be using the wrong voice commands.</p> <p>You may be saying the name differently than the way you saved it.</p> <p>The system may not be reading the name the same way you are saying it.</p>	<p>Review the media voice commands at the beginning of the media section.</p> <p>Say the song or artist exactly as listed. If you say "Play Artist Prince", the system does not play music by Prince and the Revolution or Prince and the New Power Generation.</p> <p>Make sure you are saying the complete title, such as "California remix featuring Jennifer Nettles".</p> <p>If the song titles are in all CAPS, you have to spell them. LOLA requires you to say "L-O-L-A".</p> <p>Do not use special characters in the title. The system does not recognize them.</p>
SYNC does not understand or is calling the wrong contact when I want to make a call.	You may be using the wrong voice commands.	Review the Phone voice commands at the beginning of the phone section.

SYNC™

Voice command issues		
Issue	Possible cause(s)	Possible solution(s)
	<p>You may be saying the name differently than the way you saved it.</p> <p>The system may not be reading the name the same way you are saying it.</p> <p>Contacts in your phonebook may be very short and similar, or they may contain special characters.</p> <p>Your phonebook contacts may be in CAPS.</p>	<p>Make sure you are saying the contacts exactly as they are listed. For example, if you save a contact as Joe Wilson, say "Call Joe Wilson".</p> <p>Using the SYNC phone menu, open the phonebook and scroll to the name SYNC is having trouble understanding. SYNC will read the name to you, giving you some idea of the pronunciation SYNC is expecting.</p> <p>The system works better if you list full names, such as "Joe Wilson" rather than "Joe".</p> <p>Do not use special characters, such as 123 or ICE, as the system does not recognize them.</p> <p>If a contact is in CAPS, you have to spell it. JAKE requires you to say "Call J-A-K-E".</p>

AppLink issues		
Issue	Possible cause(s)	Possible solution(s)
<p>AppLink Mobile Applications: When I select "Find New Apps," SYNC does not find any applications.</p>	<p>An AppLink capable phone is not connected to SYNC.</p>	<p>Ensure you have a compatible smartphone; an Android with OS 2.3 or higher or an iPhone 3GS or newer with iOS 5.0 or higher. Additionally, ensure your phone is paired and connected to</p>

SYNC™

AppLink issues		
Issue	Possible cause(s)	Possible solution(s)
		SYNC in order to find AppLink-capable apps on your device. iPhone users must also connect to SYNC's USB port with an Apple USB cable.
My phone is connected, but I still cannot find any apps.	AppLink-enabled apps are not installed and running on your mobile device.	Ensure you have downloaded and installed the latest version of the app from your phone's app store. Ensure the app is running on your phone. Some apps require you to register or login on the app on the phone before using them with AppLink. Also, some may have a "Ford SYNC" setting, so check the app's settings menu on the phone.
My phone is connected, my app(s) are running, but I still cannot find any apps.	Sometime apps do not properly close and re-open their connection to SYNC, over ignition cycles, for example.	Closing and restarting apps may help SYNC find the application if you cannot discover it inside the vehicle. On an Android device, if apps have an "Exit" or 'Quit' option, select that then restart the app. If the app does not have that option, you can also manually "Force Close" the app by going to the phone's settings menu, selecting 'Apps.' then finding the particular app and choosing 'Force stop.' Don't forget to restart the app afterwards, then select "Find New Apps" on SYNC.

SYNC™

AppLink issues		
Issue	Possible cause(s)	Possible solution(s)
		On an iPhone with iOS7+, to force close an app, double tap the home button then swipe up on the app to close it. Tab the home button again, then select the app again to restart it. After a few seconds, the app should then appear in SYNC's Mobile App's Menu.
My Android phone is connected, my app(s) are running, I restarted them, but I still cannot find any apps.	There is a Bluetooth bug on some older versions of the Android operating system that may cause apps that were found on your previous vehicle drive to not be found again if you have not turned off Bluetooth.	Reset the Bluetooth on your phone by turning it off and then turning Bluetooth back on. If you are in your vehicle, SYNC should be able to automatically re-connect to your phone if you press the "Phone" button.

SYNC™

AppLink issues		
Issue	Possible cause(s)	Possible solution(s)
My iPhone phone is connected, my app is running, I restarted the app but I still cannot find it on SYNC.	The USB connection to SYNC may need to be reset.	Unplug the USB cable from the phone, wait a moment, and plug the USB cable back in to the phone. After a few seconds, the app should appear in SYNC's Mobile Apps Menu. If not, "Force Close" the application and restart it.
I have an Android phone. I found and started my media app on SYNC, but there is no sound or the sound is very low.	The bluetooth volume on the phone may be low.	Try increasing the Bluetooth volume of the device by using the device's volume control buttons which are most often found on the side of the device.
I can only see some of the AppLink apps running on my phone listed in SYNC's Mobile Apps Menu.	Some Android devices have a limited number of bluetooth ports apps can use to connect. If you have more AppLink apps on your phone than the number of available Bluetooth ports, you will not see all of your apps listed in SYNC's mobile apps menu.	Force close or uninstall the apps you do not want SYNC to find. If the app has a "Ford SYNC" setting, disable that setting in the app's settings menu on the phone.

SYNC System Reset
The SYNC system in your vehicle has System Reset feature that can be performed if the function of a SYNC feature is lost. This reset is intended to restore functionality and will not erase any information previously stored in the system (Such as paired devices, phonebook, call history, text messages, or user settings). To perform a System Reset, press and hold the Seek Up (>>) button while pressing and holding the Radio Power button. Release both buttons after 2-3 seconds. Please allow a few minutes for the reset to complete. After a few minutes has passed you can resume using the SYNC system.

MyFord Touch™ (if Equipped)

GENERAL INFORMATION

WARNING



Driving while distracted can result in loss of vehicle control, crash and injury. We strongly recommend that you use extreme caution when using any device that may take your focus off the road. Your primary responsibility is the safe operation of your vehicle. We recommend against the use of any hand-held device while driving and encourage the use of voice-operated systems when possible. Make sure you are aware of all applicable local laws that may affect the use of electronic devices while driving.

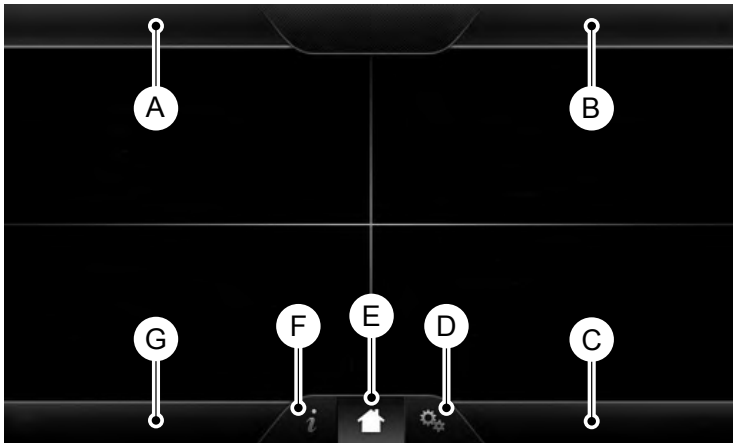

E161891

- A Phone
- B Navigation (or Information if your vehicle is not equipped with Navigation)
- C Climate (or Settings, if your vehicle is equipped with manual climate control)
- D Settings (if your vehicle is equipped with automatic climate control)
- E Home
- F Information
- G Entertainment

MyFord Touch™ (If Equipped)

This system uses a four-corner strategy to provide quick access to several vehicle features and settings. The touchscreen provides easy interaction with your cellular phone, multimedia, climate control and navigation system. The corners display any active modes within those menus, such as phone status or the climate temperature.

Note: *Some features are not available while your vehicle is moving.*

Note: *Your system is equipped with a feature that allows you to access and control audio features for 30 minutes after you switch the ignition off (and no doors open).*

PHONE

Press to select any of the following:

- Phone
- Quick Dial
- Phonebook
- History
- Messaging
- Settings

NAVIGATION

Press to select any of the following:

- My Home
- Favorites
- Previous Destinations
- Point of Interest
- Emergency
- Street Address
- Intersection
- City Center
- Map
- Edit Route
- Cancel Route

CLIMATE

Press to select any of the following:

- Driver Settings
- Recirculated Air
- Auto
- Dual
- Passenger Settings
- A/C
- Defrost



SETTINGS

Press to select any of the following:

- Clock
- Display
- Sound
- Vehicle
- Settings
- Help



HOME

Press to access your home screen. Depending on your vehicle's option package and software, your screens may vary in appearance from the descriptions in this section. Your features may also be limited depending on your market. Check with an authorized dealer for availability.



INFORMATION

Press to select any of the following:

- Services
- Travel Link
- Alerts
- Calendar
- Apps

ENTERTAINMENT

Press to select any of the following:

- AM
- FM
- SIRIUS
- CD
- USB
- BT Stereo
- SD Card
- Line In

Cleaning the Touchscreen Display

Use a clean, soft cloth such as one used for cleaning glasses. If dirt or fingerprints are still visible, apply a small amount of alcohol to the cloth. Do not pour or spray alcohol onto the display. Do not use detergent or any type of solvent to clean the display.

Using Your Bezel Controls

Depending on your vehicle and option package, you may also have these controls on your bezel:

- **Power:** Switch the media or climate features off and on.
- **VOL:** Control the volume of playing media.
- **Seek and Tune:** Use as you normally would in media modes.
- **Presets:** Press and hold a numbered button to store a radio or Sirius station; press to recall the stored station."
- **MEDIA:** Touch repeatedly to see all available media modes. The screen does not change, but you see the media change in the lower left status bar.
- **Eject:** Eject a CD from the entertainment system.
- **Climate Control:** Control the temperature, fan speed or settings of the climate control system.

Using Your Steering Wheel Controls

Depending on your vehicle and option package, you can use your steering wheel controls to interact with the touchscreen system. See **Steering Wheel** (page 73).

Support

The SYNC support team is available to help you with any questions you are not able to answer on your own.

Monday-Saturday, 8:30am-9:00pm EST.

Sunday, 10:30am-7:30pm EST.

In the United States, call: 1-800-392-3673.

In Canada, call: 1-800-565-3673.

Times are subject to change due to holidays.

Safety Information

WARNING



Driving while distracted can result in loss of vehicle control, crash and injury. We strongly recommend that you use extreme caution when using any device that may take your focus off the road. Your primary responsibility is the safe operation of your vehicle. We recommend against the use of any hand-held device while driving and encourage the use of voice-operated systems when possible. Make sure you are aware of all applicable local laws that may affect the use of electronic devices while driving.

- Do not attempt to service or repair the system. See an authorized dealer.
- Do not operate playing devices if the power cords or cables are broken, split or damaged. Place cords and cables out of the way, so they do not interfere with the operation of pedals, seats, compartments or safe driving abilities.

MyFord Touch™ (If Equipped)

- Do not leave playing devices in your vehicle during extreme conditions as it could cause them damage. See your device's user guide for further information.
- For your safety, some SYNC functions are speed-dependent. Their use is limited to when your vehicle is traveling at speeds under 3 mph (5 km/h).

Make sure that you review your device's manual before using it with SYNC.

Speed-restricted Features

Some features of this system may be too difficult to use while your vehicle is moving so they are restricted from use unless your vehicle is stationary.

- Screens crowded with information, such as Point of Interest reviews and ratings, SIRIUS Travel Link sports scores, movie times or ski conditions.
- Any action that requires you to use a keyboard is restricted, such as entering a navigation destination or editing information.
- All lists are limited so the user can view fewer entries (such as phone contacts or recent phone call entries).

See the following chart for more specific examples.

Restricted features	
Cellular Phone	Pairing a Bluetooth phone
	Adding phonebook contacts or uploading phonebook contacts (from a USB)
	List entries are limited for phone contacts and recent phone call entries
System Functionality	Editing the keypad code
	Enabling Valet Mode
	Editing settings while the rear view camera or active park assist are active
Wi-Fi and Wireless	Editing wireless settings
	Editing the list of wireless networks
Videos, Photos and Graphics	Playing video
	Editing the screen's wallpaper or adding new wallpaper
Text Messages	Composing text messages
	Viewing received text messages
	Editing preset text messages

MyFord Touch™ (If Equipped)

Restricted features

Navigation	Using the keyboard to enter a destination
	Demo navigation route
	Adding or editing Address Book entries or Avoid Areas

Privacy Information

When you connect a cellular phone to SYNC, the system creates a profile within your vehicle that links to that cellular phone. This profile helps in offering you more cellular features and operating more efficiently. Among other things, this profile may contain data about your cellular phone book, text messages (read and unread), and call history, including history of calls when your cell phone was not connected to the system. In addition, if you connect a media device, the system creates and retains an index of supported media content. The system also records a short development log of approximately 10 minutes of all recent system activity. The log profile and other system data may be used to improve the system and help diagnose any problems that may occur.

The cellular profile, media device index, and development log remain in your vehicle unless you delete them and are generally accessible only in your vehicle when the cellular phone or media player is connected. If you no longer plan to use the system or your vehicle, we recommend you perform a Master Reset to erase all stored information.

System data cannot be accessed without special equipment and access to your vehicle's SYNC module. Ford Motor Company and Ford of Canada do not access the system data for any purpose other than as described absent consent, a court order, or where required by law enforcement, other government authorities, or other third parties acting

with lawful authority. Other parties may seek to access the information independently of Ford Motor Company and Ford of Canada. For further privacy information, see the sections on 911 Assist, Vehicle Health Report, and Traffic, Directions and Information.

Using Voice Recognition

This system helps you control many features using voice commands. This allows you to keep your hands on the wheel and focus on what is in front of you. The system provides feedback through audible tones, prompts, questions and spoken confirmations depending on the situation and the chosen level of interaction (voice settings).

The system also asks short questions (confirmation prompts) when it is not sure of your request or when there are multiple possible responses to your request.

When using voice commands, words and icons may appear in the lower left status bar indicating the status of the voice session (such as Listening, Success, Failed, Paused or Try Again).

How to Use Voice Commands with Your System



Press the voice icon. After the tone, speak your command clearly.

MyFord Touch™ (If Equipped)

These commands can be said at any time during a voice session
"Cancel"
"Exit"
"Go back"
"List of commands"
"Main menu"
"Next page"
"Previous page"
"What can I say?"
"Help"

What Can I Say?

To access the available voice commands for the current session, do one of the following:

- During a voice session, press the Help icon (?) in the lower left status bar of the screen.
- Say, "What can I say?" for an on-screen listing of the possible voice commands associated with your current voice session.
- Press the voice icon. After the tone, say, "Help" to hear a list of possible voice commands.

Helpful Hints

- Make sure the interior of your vehicle is as quiet as possible. Wind noise from open windows and road vibrations may prevent the system from correctly recognizing spoken commands.
- After pressing the voice icon, wait until after the tone sounds and Listening appears before saying a command. Any command spoken prior to this does not register with the system.

- Speak naturally, without long pauses between words.
- At any time, you can interrupt the system while it is speaking by pressing the voice icon.

Accessing a List of Available Commands

- If you use the touchscreen, press the Settings icon > **Help** > **Voice Command List**.
- If you use the steering wheel control, press the voice icon. After the tone, speak your command clearly.

Available voice commands
"Audio list of commands"
"Bluetooth audio list of commands"
"Browse list of commands"
"CD list of commands"
"Climate control list of commands"
"List of commands"
"Navigation list of commands" *
"Phone list of commands"
"Radio list of commands"
"SD card list of commands"
"Sirius satellite list of commands" **
"Travel link list of commands" *
"USB list of commands"
"Voice instructions list of commands"

MyFord Touch™ (If Equipped)

Available voice commands
"Voice settings list of commands"
"Help"

* This command is only available when your vehicle is equipped with the navigation system, and the navigation system SD card is in the card slot.

** This command is only available when you have an active SIRIUS satellite radio subscription.

Voice Settings

Voice settings allow you to customize the level of system interaction, help and feedback. The system defaults to standard interaction that uses candidate lists and confirmation prompts as these provide the highest level of guidance and feedback.

- **Interaction Mode:** Novice mode provides detailed interaction and guidance while the advanced mode has less audible interaction and more tone prompts.
- **Confirmation Prompts:** The system uses these short questions to confirm your voice request. If turned off, the system simply makes a best guess as to what you requested. The system may still occasionally ask you to confirm settings.
- **Phone and Media Candidate Lists:** Candidate lists are lists of possible results from your voice commands. The system creates these lists when it has the same confidence level of several options based on your voice command.

To access these settings using the touchscreen:

1. Press the Settings icon > **Settings** > **Voice Control**.

2. Select from:
 - Interaction Mode
 - Confirmation Prompts
 - Media Candidate Lists
 - Phone Candidate Lists
 - Voice Control Volume.

To access these settings using voice commands:

1. Press the voice icon. Wait for the prompt "Please say a command". Another tone sounds to let you know the system is listening.
2. Say any of the following commands:

Voice settings using voice commands
"Confirmation prompts off"
"Confirmation prompts on"
"Interaction mode advanced"
"Interaction mode novice"
"Media candidate lists off"
"Media candidate lists on"
"Phone candidate lists off"
"Phone candidate lists on"
"Help"

Using Voice Commands with the Touchscreen Options

Your voice system has a dual mode feature which allows you to switch between using voice commands and making on-screen selections. This is available only when the system displays a list of candidates generated during a voice session. For example, when entering in a street address or trying to call a contact from the phone you paired to the system.

SETTINGS



E161968

- A Clock
- B Display
- C Sound
- D Vehicle
- E Settings
- F Help



Under this menu, you can set your clock, access and adjust the display, sound and vehicle settings as well as access settings for specific modes or the help feature.

Clock

Note: You cannot manually set the date. Your vehicle's GPS does this for you.

Note: If the battery has been disconnected, your vehicle needs to acquire a GPS signal to update the clock. Once your vehicle acquires the signal, it may take a few minutes for the update to display the correct time.



1. Press the Settings icon > **Clock**.
2. Press **+** and **-** to adjust the time.

MyFord Touch™ (If Equipped)

From this screen, you can also make other adjustments such as 12-hour or 24-hour mode, activate GPS time synchronization and have the system automatically update new time zones.

You can also turn the outside air temperature display off and on. It appears at the top center of the touchscreen, next to the time and date.

The system automatically saves any updates you make to the settings.

Display

You can adjust the touchscreen display through the touchscreen or by pressing the voice button on your steering wheel controls and when prompted, say, "Display settings".



Press the Settings icon > **Display**, to access and make adjustments using the

touchscreen.

- **Brightness** allows you to make the screen display brighter or dimmer.
- **Auto DIM**, when set to **On**, lets you use the Auto Dim Manual Offset feature. When set to **Off**, screen brightness does not change.
- **Mode** allows you to set the screen to a certain brightness or have the system automatically change based on the outside light level, or turn the display off.
 - If you select **AUTO** or **NIGHT**, you have the options of turning the display's Auto Dim feature on or off and changing the Auto Dim Manual Offset feature.

- **Auto Dim Manual Offset** allows you to adjust screen dimming as the outside lighting conditions change from day to night. This feature also allows you to adjust screen brightness using the instrument panel dimming control.
- **Edit Wallpaper**
 - You can have your touchscreen display the default photo or upload your own.

Uploading Photos for Your Home Screen Wallpaper

Note: You cannot load photos directly from your camera. You must access the photos either from your USB mass storage device or from an SD card.

Note: Photographs with extremely large dimensions (such as 2048 x 1536) may not be compatible and appear as a blank (black) image on the display.

Your system allows you to upload and view up to 32 photos.



To access, press the Settings icon > **Display** > **Edit Wallpaper**, and then follow the system prompts to upload your photographs.

Only photographs that meet the following conditions display:

- Compatible file formats are as follows: .jpg, .gif, .png, .bmp
- Each file must be 1.5 MB or less.
- Recommended dimensions: 800 x 384

Sound



Press the **Settings** icon > **Sound**, then select from the following:

MyFord Touch™ (If Equipped)

Sound
Bass
Midrange
Treble
Set Balance and Fade
DSP*
Occupancy Mode*
Speed Compensated Volume

* Your vehicle may not have these sound settings.

Vehicle



Press the Settings icon > **Vehicle**, then select from the following:

- Ambient Lighting.
- Vehicle Health Report.
- Camera Settings.
- Enable Valet Mode.

Ambient Lighting (If Equipped)

When you turn this feature on, ambient lighting illuminates various places, such as the footwells, with a choice of colors. To access and make adjustments:



1. Press the Settings icon > **Vehicle** > **Ambient Lighting**.
2. Touch the desired color.
3. Use the scroll bar to increase or decrease the intensity.

To turn the feature on or off, press the power button.

Vehicle Health Report (If Equipped, US Only)

Turn **Automatic Reminders** on and off and set the mileage interval at which you would like to receive the reports. Press **?** for more information on these selections.

When done making your selections, press **Run Vehicle Health Report Now** if you want your report.

You can find more information on Vehicle Health Report in this chapter. See **Information** (page 476).

Camera Settings

This menu allows you to access settings for your rear view camera.



Press the Settings icon > **Vehicle** > **Camera Settings**, then select from the following settings:

- Enhanced Park Aids.
- Rear Camera Delay.

You can find more information on the rear view camera in another chapter. See **Rear View Camera** (page 206).

Enable Valet Mode

Valet mode allows you to lock the system. No information is accessible until the system is unlocked with the correct PIN.



1. Press the Settings icon > **Vehicle** > **Enable Valet Mode**.
2. Enter a four-digit pin twice, as prompted.

After you press **Continue**, the system locks until you enter the PIN again.

Note: *If the system locks, and you need to reset the PIN, please contact the Customer Relationship Center.*

MyFord Touch™ (If Equipped)

United States: 1-800-392-3673

Canada: 1-800-565-3673

Settings

Access and adjust system settings, voice features, as well as phone, navigation and wireless settings.

System



Press the Settings icon > **Settings** > **System**, then select from the following:

System	
Language	Select to have the touchscreen display in English, Spanish or French.
Distance	Select to display units in kilometers or miles.
Temperature	Select to display units in Celsius or Fahrenheit.
System Prompt Volume	Adjust the volume of voice prompts from the system.
Touch Screen Button Beep	Select to have the system beep to confirm choices made through the touchscreen.
Touch Panel Button Beep	Select to have the system beep to confirm button choices made through the climate or audio system.
Keyboard Layout	Have the touchscreen keyboard display in QWERTY or ABC format.
Install Applications	Install any downloaded applications or view the current software licenses.
Master Reset	Select to restore factory defaults. This erases all personal settings and personal data.

Voice Control



Press the Settings icon > **Settings** > **Voice Control**, then select from the following:

MyFord Touch™ (If Equipped)

Voice control	
Interaction Mode	Standard interaction mode provides more detailed interaction and guidance. Advanced mode has less audible interaction and more tone prompts.
Confirmation Prompts	Have the system ask you short questions if it has not clearly heard or understood your request.*
Media Candidate Lists	Candidate lists are possible results from your voice commands. The system simply makes a best guess at your request with these turned off.
Phone Candidate Lists	Candidate lists are possible results from your voice commands. The system simply makes a best guess at your request with these turned off.
Voice Control Volume	This allows you to adjust the system's voice volume level.

* Even with confirmation prompts turned off, the system may occasionally ask you to confirm settings.

Media Player



Press the Settings icon > **Settings** > **Media Player**, then select from the following:

Media player	
Autoplay	When this feature is on, the system automatically switches to the media source upon initial connection. This allows you to listen to music during the indexing process. When this feature is off, the system does not automatically switch to the inserted media source.
Bluetooth Devices	Select to connect, disconnect, add or delete a device. You can also set a device as your favorite so that the system automatically attempts to connect to that device at every ignition cycle.
Index Bluetooth Audio Devices	When this feature is on, the system automatically indexes media on your connected Bluetooth device.

MyFord Touch™ (If Equipped)

Media player	
Gracenote Database Info	This allows you to view the version level of the Gracenote Database.
Gracenote Management	With this feature on, the Gracenote Database supplies metadata information for your music files. This overrides information from your device. This feature defaults to off.
Cover Art Priority	With this feature on, the Gracenote Database supplies cover art for your music files. This overrides any art from your device. This feature defaults to Media Player.

Navigation



Press the Settings icon > **Settings** > **Navigation**, then select from the following:

Navigation	
Map Preferences	Switch breadcrumbs on and off.
	Have the system display your turn list top to bottom or bottom to top.
	Switch the Parking POI notification on and off.
Route Preferences	Choose to have the system display the Shortest, Fastest or most Ecological route first. If you set Always Use Preferred Route to Yes , the system uses the selected route type to calculate only one route to the desired destination. Always Use Preferred Route bypasses route selection in destination programming. The system only calculates one route based on the preferred route setting. Eco Time Penalty allows you to select a low, medium or high cost for the calculated Eco Route. The higher the setting, the longer the time allotment is for the route.
	Have the system avoid freeways.
	Have the system avoid tollroads.
	Have the system avoid ferries or car trains.
	Have the system use HOV (high-occupancy vehicle) lanes.
Navigation Preferences	Have the system use guidance prompts.

MyFord Touch™ (If Equipped)

Navigation	
	Have the system automatically fill in State/Province information.
Traffic Preferences	Have the system display areas where roadwork occurs.
	Have the system display incident icons.
	Have the system display areas where difficult driving conditions may occur.
	Have the system display areas where snow and ice on the road may occur.
	Have the system display any smog alerts.
	Have the system display weather warnings.
	Have the system display where there may be reduced visibility.
	Have the system switch on your radio for traffic announcements.
	Have the system avoid traffic problems automatically.
	Switch traffic alert notifications on and off.
	Have the system display accident icons.
	Have the system display traffic jam icons.
Have the system display closed roads.	
Avoid Areas	Enter specific areas that you would like to avoid on planned navigation routes.

Phone



Press the Settings icon > **Settings** > **Phone**, then select from the following:

MyFord Touch™ (if Equipped)

Phone	
Bluetooth Devices	Connect, disconnect, add or delete a device, as well as save it as a favorite.
Bluetooth	Turn Bluetooth on and off.
Do Not Disturb	Have all calls go directly to your voice mail and not ring inside your vehicle. With this feature turned on, text message notifications are also suppressed and do not ring inside your vehicle.
911 Assist	Turn on or turn off the 911 Assist feature. See Information (page 476).
Phone Ringer	Select the type of notification for phone calls - ring tone, beep, text to speech, or have it be silent.
Text Message Notification	Select the type of notification for text messages - alert tone, beep, text to speech, or have it be silent.
Internet Data Connection	If compatible with your phone, you can adjust your internet data connection. Select to make your connection profile with the personal area network or to turn off your connection. You can also choose to adjust your settings or have the system always connect, never connect when roaming or query on connect. Press ? for more information.
Manage Phonebook	Access features, such as automatic phonebook download, re-download your phonebook, add contacts from your phone as well as delete or upload your phonebook.
Roaming Warning	Have the system alert you when in Roaming mode.

Wireless & Internet

Your system has a Wi-Fi feature that creates a wireless network within your vehicle, thereby allowing other devices (such as personal computers or phones) in your vehicle to speak to each other, share files or play games. Using this Wi-Fi

feature, everyone in your vehicle can also gain access the internet if you have a USB mobile broadband connection inside your vehicle, your phone supports personal area networking and if you park outside a wireless hotspot.



Press the Settings icon > **Settings > Wireless & Internet**, then select from the following:

MyFord Touch™ (If Equipped)

Wi-Fi	
Wi-Fi Settings	<p>Wi-Fi Network (Client) Mode turns the Wi-Fi feature on and off in your vehicle. Make sure you turn it on for connectivity purposes.</p> <p>Choose a Wireless Network allows you to use a previously stored wireless network. You can categorize by alphabetical listing, priority and signal strength. You can also choose to search for a network, connect to a network, disconnect from a network, receive more information, prioritize a network or delete a network.</p> <p>Gateway (Access Point) Mode makes SYNC an access point for a phone or a computer when turned on. This forms the local area network within your vehicle for things, such as game playing, file transfer and internet browsing. Press ? for more information.</p> <p>Gateway (Access Point) Settings allows you to view and change settings for using SYNC as the internet gateway.</p> <p>Gateway (Access Point) Device List allows you to view recent connections to your Wi-Fi system.</p>
USB Mobile Broadband	<p>Instead of using Wi-Fi, your system can also use a USB mobile broadband connection to access the internet. (You must turn on your mobile broadband device on your personal computer before connecting it to the system.) This screen allows you to set up what is your typical area for your USB mobile broadband connection. (USB mobile broadband settings may not display if the device is already on.) You can select the following: Country, Carrier, Phone Number, User Name and Password.</p>
Bluetooth Settings	<p>Shows you the currently paired devices as well as giving you your typical Bluetooth options to connect, disconnect, set as favorite, delete and add device. Bluetooth is a registered trademark of the Bluetooth SIG.</p>
Prioritize Connection Methods	<p>Choose your connection methods and change them as needed. You can select to Change Order and have the system either always attempt to connect using a USB mobile broadband or using Wi-Fi.</p>

MyFord Touch™ (If Equipped)



The Wi-Fi CERTIFIED Logo is a certification mark of the Wi-Fi Alliance.

Help



Press the Settings icon > **Help**, then select from the following:

E142626

Help	
System Information	Touchscreen system serial number
	Your vehicle identification number (VIN)
	Touchscreen system software version
	Navigation system version
	Map database version
	Sirius satellite radio ESN
	Gracenote Database Information and Library version
Software Licenses	View the licenses for any software and applications installed on your system.
Driving Restrictions	Certain features are not accessible when your vehicle is moving.
911 Assist	Turn on and turn off the 911 Assist feature. See Information (page 476).
	In Case of Emergency (ICE) Quick Dial: allows you to save up to two numbers as ICE contacts for quick access if there is an emergency. Select Edit to access your phonebook and then select the desired contacts. The numbers then appear as options on this screen for the ICE 1 and ICE 2 buttons. The ICE contacts you select appear at the end of the 911 Assist call process.
Voice Command List	View categorized lists of voice commands.

MyFord Touch™ (If Equipped)

To access Help using the voice commands, press the voice button, then, after the tone,

say "Help". The system provides allowable voice commands for the current mode.

ENTERTAINMENT



E161892

- A AM 1 and AM AST
- B FM 1, FM 2 and FM AST
- C SIRIUS
- D CD
- E USB
- F Touch this button to scroll down for more options, such as SD Card, BT Stereo and Line In
- G These buttons change with the media mode you are in.
- H Radio memory presets and CD controls.

Note: Some features may not be available in your area. Contact an authorized dealer for more information.

You can access these options using the touchscreen or voice commands.

Browsing Device Content

When listening to audio on a device, you can browse through other devices without having to change sources. For example, if you are currently listening to audio on an SD card, you can browse all the artists that are stored on your USB device.

MyFord Touch™ (If Equipped)



Press the voice icon on the steering wheel. When prompted, you can say:

"BROWSE" within devices
"Browse"
"Browse <league> games" ^{**}
"Browse <Sirius category> channels" ^{**}
"Browse SD card"
"Browse Sirius channel guide" ^{**}
"Browse USB"
"Help"

^{*} If you only say, "Browse", you can then say any commands in the following chart.

^{**} This command is only usable if you have an active subscription to SIRIUS satellite radio.

"BROWSE"
"<League> Games" [*]
"<Sirius category> channels" [*]
"SD card" ^{**}
"Sirius Channel Guide" [*]
"USB" ^{**}
"Help"

^{*} This command is only usable if you have an active subscription to SIRIUS satellite radio.

^{**} For more commands in SD card or USB mode, see the "SD Card and USB Port" section of this chapter.

Your voice system allows you to change audio sources with a simple voice command. For example, if you are listening to music on a USB device, then want to switch to a satellite radio channel, simply press the voice button on the steering wheel controls and say the name of the SIRIUS station (such as, "the Highway"). The following voice commands are available at the top level of the voice session no matter which current audio source you are listening to (such as a USB device or SIRIUS satellite radio).

Note: *This is only available when your MyFord Touch system language is set to North American English.*

Sample commands
"<87.9-107.9>"
"<530-1710>"
"<Channel name>" [*]
"AM <530-1710>"
"FM <87.9-107.9>"
"Play [album] <name>" ^{**}
"Play [artist] <name>" ^{**}
"Play [genre] <name>" ^{**}
"Play [playlist] <name>" ^{**}
"Play [song] <name>" ^{**}
"Play <name>"
"Play <name (song or album)> by <artist name>"

Sample commands
"Sirius <0-223>"*
"Sports games"*

* This command is only usable if you have an active subscription to SIRIUS satellite radio.

** The commands that have [] around the word means that the word is optional. For example, if you say, "Play Metallica", this is the same as the voice command, "Play [artist] <name>".

AM/FM Radio



Touch the **AM** or **FM** tab to listen to the radio.

To change between AM and FM presets, just touch the **AM** or **FM** tab.

Memory Presets

Save a station by pressing and holding one of the memory preset areas. There is a brief mute while the radio saves the station. Sound returns when finished.

HD Radio

Touch this button to turn HD Radio on. The light on the button illuminates when the feature is on. HD Radio allows you to receive radio broadcasts digitally, where available, providing free, crystal-clear sound. See HD Radio information later in this chapter.

Scan

Touch this button to go to the next strong AM or FM radio station. The light on the button illuminates when the feature is on.

Options

Sound Settings

Touch this button to adjust settings for:

- Bass
- Midrange
- Treble
- Balance and Fade
- DSP (Digital Signal Processing)
- Occupancy Mode
- Speed Compensated Volume.

Note: *Your vehicle may not have all these sound settings.*

Set PTY for Seek/Scan

This allows you to select a category of music you would like to search for. You can then choose to either seek or scan for the stations playing that category.

RDS Text Display

This allows you to view the information broadcast by FM stations.

AST

AST (Autostore) allows you to have the system automatically store the six strongest stations in your current location.

TAG Button

This feature is available when HD Radio is on, and allows you to tag a song to download later. When you select On, **TAG** appears on-screen when HD Radio is active. You can touch **TAG** to save the information of the song that is playing. When you plug in your portable music player, the information transfers, if supported by your device. When you are connected to iTunes, the tags appear to remind you of the songs you would like to download. See HD Radio information later in this chapter.

Direct Tune

Touch this button to manually enter the desired station number. Touch **Enter** when you are done.

HD Radio™ Information (If Available)

Note: *HD Radio broadcasts are not available in all markets.*

HD Radio technology is the digital evolution of analog AM/FM radio. Your system has a special receiver that allows it to receive digital broadcasts (where available) in addition to the analog broadcasts, it already receives. Digital broadcasts provide a better sound quality than analog broadcasts with free, crystal-clear audio and no static or distortion. For more information, and a guide to available stations and programming, please visit www.hdradio.com.

When HD Radio is on and you tune to a station broadcasting HD Radio technology, you may notice the following indicators on your screen:



E142616

The HD Radio logo is grey when acquiring a digital station, and then changes to orange when digital audio is playing. When this logo is available, you may also see Title and Artist fields on-screen.

The multicast indicator appears in FM mode (only) if the current station is broadcasting multiple digital broadcasts. The highlighted numbers signify available digital channels where new or different content is available. HD1 signifies the main programming status and is available in analog and digital broadcasts. Other multicast stations (HD2 through HD7) are only available digitally.

TAG allows you to save a song to download later when you are on an acquired HD Radio station and the feature is on. To turn the feature on and use it:

1. Press **AM** or **FM** > **Options** > **TAG Button** > **On**.
2. When you hear a song you like, touch **TAG**.
3. The system automatically saves the song's information and transfers it to your portable music player (if supported) when you connect it to the system. The system automatically transfers the tag to your player (if already connected) and a pop-up confirms the transfer.
4. When you access iTunes with your portable music player, the tags appear to you as a reminder. The system allows you to tag up to approximately 100 songs. For a list of devices that support tagging, see www.SYNCMYRide.com, www.SYNCMYRide.ca or www.syncmaroute.ca.

MyFord Touch™ (If Equipped)

When HD Radio broadcasts are active, you can access the following functions:

- **Scan** allows you to hear a brief sampling of all available stations. This feature still works when HD Radio reception is on, although it does not scan for HD2-HD7 channels. You may see the HD logo appear if the station has a digital broadcast.
- **Memory presets** allow you to save an active channel as a memory preset. Touch and hold a memory preset slot until the sound returns. There is a brief mute while the radio saves the station. Sound returns when finished. When switching to an HD2 or HD3 memory preset, the sound mutes before the digital audio plays, because the system has to reacquire the digital signal.

Note: *As with any saved radio station, you cannot access the saved station if your vehicle is outside the station's reception area.*

HD Radio Reception and Station Troubleshooting

Potential reception issues	
Reception area	If you are listening to a multicast station and you are on the fringe of the reception area, the station may mute due to weak signal strength.
	If you are listening to HD1, the system switches back to the analog broadcast until the digital broadcast is available again. However, if you are listening to any of the possible HD2-HD7 multicast channels, the station mutes and stays muted unless it is able to connect to the digital signal again.
Station blending	When the system first receives a station (aside from HD2-HD7 multicast stations), it first plays the station in the analog version. Once the receiver verifies the station is an HD Radio station, it shifts to the digital version. Depending on the station quality, you may hear a slight sound change when the station changes from analog to digital. Blending is the shift from analog to digital sound or digital back to analog sound.

In order to provide the best possible experience, use the contact form to report any station issues found while listening to a station broadcasting with HD Radio technology. Independent entities own and operate each station. These stations are responsible for ensuring all audio streams and data fields are accurate.

MyFord Touch™ (If Equipped)

Potential station issues		
Issues	Cause	Action
Echo, stutter, skip or repeat in audio. Increase or decrease in audio volume.	This is poor time alignment by the radio broadcaster.	No action required. This is a broadcast issue.
Sound fading or blending in and out.	The radio is shifting between analog and digital audio.	No action required. The reception issue may clear up as you continue to drive.
There is an audio mute delay when selecting HD2 or HD3, multicast preset or Direct Tune .	The digital multicast is not available until the HD Radio broadcast is decoded. Once decoded, the audio is available.	No action required. This is normal behavior. Wait until the audio is available.
Cannot access HD2 or HD3 multicast channel when recalling a preset or from a direct tune.	The previously stored multicast preset or direct tune is not available in your current reception area.	No action required. The station is not available in your current location.
Text information does not match currently playing audio.	Data service issue by the radio broadcaster.	Fill out the station issue form at website listed below.*
There is no text information shown for currently selected frequency.	Data service issue by the radio broadcaster.	Fill out the station issue form at website listed below.*
HD2-HD7 stations not found when Scan is pressed.	Pressing Scan disables HD2-HD7 channel search.	No action required. This is normal behavior.

* http://www.ibiquity.com/automotive/report_radio_station_experiences

HD Radio Technology manufactured under license from iBiquity Digital Corp. U.S. and foreign patents. HD Radio and the HD and HD Radio logos are proprietary trademarks of iBiquity Digital Corp. Ford Motor Company and iBiquity Digital Corp. are not responsible for the content sent using HD Radio technology. Content may be changed, added or deleted at any time at the station owner's discretion.

Radio Voice Commands



If you are listening to the radio, press the voice button on the steering wheel controls. When prompted, say any of the following commands.

If you are not listening to the radio, press the voice button and, after the tone, say "Radio", then any of the following commands.

MyFord Touch™ (If Equipped)

"RADIO"
"<87.9-107.9>"
"<87.9-107.9> HD" ¹
"<530-1710>"
"AM"
"AM <530-1710>"
"AM autosest"
"AM autosest preset <#>"
"AM preset <#>"
"Browse" ²
"FM"
"FM <87.9-107.9>"
"FM <87.9-107.9> HD <#>" ¹
"FM autosest"
"FM autosest preset <#>"
"FM preset <#>"
"FM 1"
"FM 1 preset <#>"
"FM 2"
"FM 2 preset <#>"
"HD <#>" ¹
"Preset <#>"
"Radio off"
"Radio on"
"Set PTY"

"RADIO"
"Tune" ³
"Help"

¹ If available.

² If you have said "Browse", see the "Browse" chart later in this section.

³ If you have said "Tune", see the following "Tune" chart.

"TUNE"
"<530-1710>"
"<87.9-107.9>"
"<87.9-107.9> HD <#>" [*]
"AM"
"AM <530-1710>"
"AM autosest"
"AM autosest preset <#>"
"AM preset <#>"
"FM"
"FM <87.9-107.9>"
"FM <87.9-107.9> HD <#>" [*]
"FM autosest"
"FM autosest preset <#>"
"FM preset <#>"
"FM 1"
"FM 1 preset <#>"
"FM 2"
"FM 2 preset <#>"

MyFord Touch™ (If Equipped)

"TUNE"
"HD <#>"*
"Preset <#>"
"Help"

* If available.

SIRIUS® Satellite Radio (If Activated)



Press the lower left corner of the touchscreen, and then select the **SIRIUS** tab.

Memory Presets

Save a channel by pressing and holding one of the memory preset areas. There is a brief mute while the radio saves the channel. Sound returns when finished.

ALERT

Save the current song, artist, or team as a favorite.

If you are listening to music, you can save the song or artist, so the system can alert you when they are playing on a satellite radio channel. If you are listening to a sporting event, you can save your favorite teams so the system can alert you when they are playing on a satellite radio channel. You can also edit alerts or turn alerts on or off.

When an alert appears on the screen, you can choose to tune to the channel, cancel the alert or turn off alerts.

Note: *SIRIUS does not support the Alert feature on all channels. Ford Motor Company shall not be responsible for Alert feature variation.*

Replay

Replay audio on the current channel. You can replay approximately 45 minutes of audio as long as you have remained tuned to the current station. Changing stations erases the previous audio.

While in replay mode:

- Press and release the seek buttons to hear the previous or next song.
- Press and hold the seek buttons to reverse or fast forward in the current track.
- Press play or pause to play or pause the audio.
- Press **Replay** to return to live audio if you have been using the feature to replay audio.

Scan

Touch this button to hear a brief sampling of channels.

Options

Touch this button to view and adjust various media settings.

Sound Settings

Touch this button to adjust settings for:

- Bass
- Midrange
- Treble
- Balance and Fade
- DSP (Digital Signal Processing)
- Occupancy Mode
- Speed Compensated Volume.

Note: *Your vehicle may not have all these sound settings.*

MyFord Touch™ (If Equipped)

Set Category for Seek/Scan

This allows you to select a category of music you would like to search for. You can then choose to either seek or scan for the stations playing that category.

Parental Lockout

This allows you to lock and unlock channels, change or reset your PIN or unlock all channels. To use this feature, you need your initial PIN, which is 1234.

Artist/Title/Team Alerts

This feature allows you turn alerts on and off.

Electronic Serial Number (ESN)

SIRIUS requires this number when communicating with you about your account.

Direct Tune

Touch this button to manually enter the desired satellite channel number. Touch **Enter** when you are done.

Browse

Touch this button to view a list of all available stations. Scroll to see more categories. Touch the station you want to listen to.

Touch **Skip** if you want to skip this channel.

Touch **Lock** if you do not want anyone to listen to this channel.

Touch **Title** or **Artist** to see song and artists on other stations.

SIRIUS Satellite Radio Information

Note: SIRIUS reserves the unrestricted right to change, rearrange, add or delete programming including canceling, moving or adding particular channels, and its prices, at any time, with or without notice to you. Ford Motor Company shall not be responsible for any such programming changes.



E142593

SIRIUS satellite radio is a subscription-based satellite radio service that broadcasts a variety of music, sports, news, weather, traffic and entertainment programming. Your factory-installed SIRIUS satellite radio system includes hardware and a limited subscription term that begins on the date of sale or lease of your vehicle. See an authorized dealer for availability.

For more information on extended subscription terms (a service fee is required), the online media player and a list of SIRIUS satellite radio channels, and other features, please visit www.siriusxm.com in the United States, www.sirius.ca in Canada, or call SIRIUS at 1-888-539-7474.

Note: This receiver includes the eCos real-time operating system. eCos is published under the eCos License.

MyFord Touch™ (If Equipped)

Satellite Radio Electronic Serial Number (ESN)

You need your ESN to activate, modify or track your satellite radio account. The ESN

is on the System Information Screen (SR ESN:XXXXXXXXXXXX). To access your ESN, touch the bottom left corner of the touchscreen. Touch **SIRIUS > Options**.

SIRIUS Satellite Radio Reception Factors and Troubleshooting

Potential reception issues	
Antenna obstructions	For optimal reception performance, keep the antenna clear of snow and ice build-up and keep luggage and other materials as far away from the antenna as possible.
Terrain	Hills, mountains, tall buildings, bridges, tunnels, freeway overpasses, parking garages, dense tree foliage and thunderstorms can interfere with your reception.
Station overload	When you pass a ground-based broadcast-repeating tower, a stronger signal may overtake a weaker one and the audio system may mute.
Satellite radio signal interference	Your display may show ACQUIRING... to indicate the interference and the audio system may mute.

Troubleshooting tips		
Radio display	Cause	Action
Acquiring...	Radio requires more than two seconds to produce audio for the selected channel.	No action required. This message should disappear shortly.
Sat Fault/SIRIUS System Failure.	There is an internal module or system failure present.	If this message does not clear shortly, or with an ignition key cycle, your receiver may have a fault. See an authorized dealer for service.
Invalid Channel.	The channel is no longer available.	Tune to another channel or choose another preset.
Unsubscribed Channel.	Your subscription does not include this channel.	Contact SIRIUS at 1-888-539-7474 to subscribe to the channel, or tune to another channel.

MyFord Touch™ (If Equipped)

Troubleshooting tips		
Radio display	Cause	Action
No Signal.	The signal is lost from the SIRIUS satellite or SIRIUS tower to your vehicle antenna.	The signal is blocked. When you move into an open area, the signal should return.
Updating.	Update of channel programming in progress.	No action required. The process may take up to three minutes.
Call SIRIUS 1-888-539-7474.	Your satellite service is no longer available.	Contact SIRIUS at 1-888-539-7474 to resolve subscription issues.
None found. Check Channel Guide.	All the channels in the selected category are either skipped or locked.	Use the channel guide to turn off the Lock or Skip function on that station.
Subscription Updated.	SIRIUS has updated the channels available for your vehicle.	No action required.

SIRIUS Satellite Radio Voice Commands



If you are listening to SIRIUS satellite radio, press the voice button on the steering wheel controls. When prompted, say any of the following commands.

If you are not listening to SIRIUS satellite radio, press the voice button and, after the tone, say "SIRIUS", then any of the following commands.

"SIRIUS"
"<Channel name>"
"Preset <#>"
"SAT"
"SAT preset <#>"

"SIRIUS"
"SAT 1"
"SAT 1 Preset <#>"
"SAT 2"
"SAT 2 preset <#>"
"SAT 3"
"SAT 3 preset <#>"
"Sirius <0-223>"
"Sirius off"
"Sirius on"
"Sports game"

MyFord Touch™ (If Equipped)

"SIRIUS"
"Tune"***
"Help"

* If you have said "Sports game", see the following "Sports game" chart.

** If you have said "Tune", see the following "Tune" chart.

"SPORTS GAME"
"Tune to the <college name> game"
"Tune to the <team city> game"
"Tune to the <team city> <team name> game"
"Tune to the <team name> game"
"Help"

"TUNE"
"<Channel Name>"
"Preset <#>"
"SAT"
"SAT 1"
"SAT 1 preset <#>"
"SAT 2"
"SAT 2 preset <#>"
"SAT 3"
"SAT 3 preset <#>"
"Sirius <0-223>"
"Help"

CD



Press the lower left corner of the touchscreen, and then select the **CD** tab.

You can also advance and reverse the current track or current folder, if applicable.

Repeat

Touch this button to repeat the currently playing track, all tracks on the disc or turn the feature off if already on.

Shuffle

Touch this button to play the tracks or entire albums in random order, or turn the feature off if already on.

Scan

Touch this button to hear a brief sampling of all available tracks.

More Info

Touch this button to see disc information.

Options

Sound Settings

Touch this button to adjust settings for:

- Bass
- Midrange
- Treble
- Balance and Fade
- DSP (Digital Signal Processing)
- Occupancy Mode
- Speed Compensated Volume.

Note: *Your vehicle may not have all these sound settings.*

Compression

Touch this button to turn the compression feature on and off.

MyFord Touch™ (If Equipped)

Browse

Touch this button to look through all available CD tracks.

CD Voice Commands



If you are listening to a CD, press the voice button on the steering wheel controls. When prompted, say any of the following commands.

If you are not listening to a CD, press the voice button and, after the tone, say "CD", then any of the following commands.

"CD"
"Pause"
"Play"
"Play next track"
"Play previous track"
"Play track <1-512>"
"Repeat"
"Repeat folder"
"Repeat off"
"Repeat track"
"Shuffle"
"Shuffle CD"
"Shuffle folder"
"Shuffle off"
"Help"

*This applies to WMA or MP3 files only.

SD Card Slot and USB Port

SD Card

Note: Your SD card slot is spring-loaded. To remove the SD card, press the card in and the system ejects it. Do not attempt to pull the card to remove it as this could cause damage.

Note: The navigation system also uses this card slot. See **Navigation** (page 488).

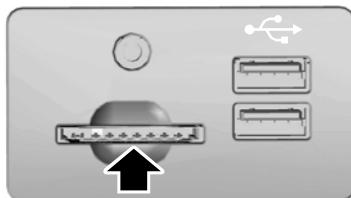

E175710

The SD card slot is located in the center console. To access and play music from your device, press the lower left corner of the touchscreen.



E142620

SD logo is a trademark of SD-3C, LLC.

USB Port



E175711

The USB ports are located in the center console. To access and play music from your device, press the lower left corner of the touchscreen.

This feature allows you to plug in media playing devices, memory sticks, flash drives or thumb drives, and charge devices if they support this feature.

Playing Music from Your Device

Note: *The system is capable of indexing up to 30,000 songs.*



Insert your device and select the **SD Card** or **USB** tab once the system recognizes it. You can then select from the following options:

Repeat

This feature replays the currently playing song or album.

Shuffle

Touch this button to play music on the selected album or folder in random order.

Similar Music

This feature allows you to choose music similar to what is currently playing.

More Info

Touch this button to see disc information such as current track, artist name, album and genre.

Options

Touch this button to view and adjust various media settings.

Sound Settings allows you to adjust settings for:

- Bass
- Midrange
- Treble
- Balance and Fade
- DSP (Digital Signal Processing)
- Occupancy Mode
- Speed Compensated Volume.

Note: *Your vehicle may not have all these sound settings.*

Media Player Settings allows you to select more settings, which is under Media Player. See **Settings** (page 443).

Device Information displays software and firmware information about the currently connected media device.

Update Media Index indexes your device when you connect it for the first time and each time the content changes (such as adding or removing tracks) to make sure you have the latest voice commands available for all media on the device.

Browse

This feature allows you to view the contents of the device. It also allows you to search by categories, such as genre, artist or album.

If you want to view song information such as Title, Artist, File, Folder, Album, and Genre, touch the on-screen album art.

MyFord Touch™ (If Equipped)

You can also touch **What's Playing** to hear how the system pronounces the current band and song. This can be helpful when using voice commands to make sure the system correctly plays your request.

SD Card and USB Voice Commands



If you are listening to a USB device or an SD card, press the voice button on the steering wheel controls. When prompted, say any of the following commands.

If you are not listening to a USB device or an SD card, press the voice button and, after the tone, say "USB" or "SD card", then any of the following commands.

"USB" or "SD CARD"
"Browse"
"Next"
"Pause"
"Play"
"Play album <name>"
"Play all"
"Play artist <name>"
"Play audiobook <name>"
"Play author <name>"
"Play composer <name>"
"Play folder <name>"
"Play genre <name>"
"Play movie <name>"**
"Play music video <name>"**
"Play playlist <name>"

"USB" or "SD CARD"
"Play podcast <name>"
"Play podcast episode <name>"
"Play similar music"
"Play song <name>"
"Play TV show <name>"**
"Play TV show episode <name>"**
"Play video <name>"**
"Play video podcast <name>"**
"Play video podcast episode <name>"**
"Play video playlist <name>"**
"Previous"
"Repeat all"
"Repeat off"
"Repeat one"
"Shuffle"
"Shuffle album"
"Shuffle off"
"What's this?"
"Help"

* If you have said you would like to browse your USB or SD card, the system prompts you to specify what you would like to browse. When prompted, see the following "Browse" chart.

** These commands are only available in USB mode and are device-dependent.

MyFord Touch™ (If Equipped)

"BROWSE"
"Album <name>"
"All albums"
"All artists"
"All audiobooks"
"All authors"
"All composers"
"All folders"
"All genres"
"All movies"*
"All music videos"*
"All playlists"
"All podcasts"
"All songs"
"All TV shows"
"All video playlists"*
"All video podcasts"*
"All videos"
"Artist <name>"
"Audiobook <name>"
"Author <name>"
"Composer <name>"
"Folder <name>"
"Genre <name>"
"Playlist <name>"
"Podcast <name>"

"BROWSE"
"TV show <name>"*
"Video <name>"*
"Video playlist <name>"*
"Video podcast <name>"*
"Help"

* This command is only available in USB mode and is device-dependent.

Supported Media Players, Formats and Metadata Information

SYNC is capable of hosting nearly any digital media player, including iPod, Zune™, plays from device players, and most USB drives. Supported audio formats include MP3, WMA, WAV and AAC.

It is also able to organize your indexed media from your playing device by metadata tags. Metadata tags, which are descriptive software identifiers embedded in the media files, provide information about the file.

If your indexed media files contain no information embedded in these metadata tags, SYNC may classify the empty metadata tags as **Unknown**.

Bluetooth Audio

Your system allows you to stream audio over your vehicle's speakers from your connected, Bluetooth-enabled cellular phone.



To access, press the lower left corner on the touchscreen, then select the **BT Stereo** tab.

Bluetooth Audio Voice Commands



If you are listening to a Bluetooth audio device, press the voice button on the steering wheel control. When prompted, say "Next song", "Pause", "Play" or "Previous song".

If you are not listening to a Bluetooth audio device, press the voice button and, after the tone, say "Next song", "Pause", "Play" or "Previous song".

Line In

WARNINGS



Driving while distracted can result in loss of vehicle control, crash and injury. We strongly recommend that you use extreme caution when using any device that may take your focus off the road. Your primary responsibility is the safe operation of your vehicle. We recommend against the use of any handheld device while driving and encourage the use of voice-operated systems when possible. Make sure you are aware of all applicable local laws that may affect the use of electronic devices while driving.



For safety reasons, do not connect or adjust the settings on your portable music player while your vehicle is moving.



Store the portable music player in a secure location, such as the center console or the glove box, when your vehicle is moving. Hard objects may become projectiles in a crash or sudden stop, which may increase the risk of serious injury. The audio extension cable must be long enough to allow the portable music player to be safely stored while your vehicle is moving.

Your auxiliary input jack allows you to play music from your portable music player over your vehicle's speakers. The jack is located in your center console.

Press the lower left corner of the touchscreen, and then select **Line In**.

To use the auxiliary input jack feature, make sure that your portable music player is designed for use with headphones and that it is fully charged. You also need an audio extension cable with stereo male 1/8-inch (3.5 millimeter) connectors at both ends.

1. Switch off the engine, radio and portable music player. Set the parking brake and put the transmission in position **P**.
2. Attach one end of the audio extension cable to the headphone output of your player and the other end into the adapter in one of the jacks inside the center console.
3. Press the lower left corner on the touchscreen. Select either a tuned FM station or a CD (if there is a CD already loaded into the system).
4. Adjust the volume as desired.
5. Turn the portable music player on and adjust the volume to ½ the maximum.
6. Press the lower left corner on the touchscreen. Select the **Line In** tab. (You should hear audio from your portable music player although it may be low.)
7. Adjust the sound on your portable music player until it reaches the level of the FM station or CD by switching back and forth between the controls.

MyFord Touch™ (If Equipped)

Troubleshooting

- Do not connect the audio input jack to a line level output. The jack only works correctly with devices that have a headphone output with a volume control.
- Do not set the portable music player's volume level higher than is necessary to match the volume of the CD or FM radio as this causes distortion and reduces sound quality.
- If the music sounds distorted at lower listening levels, turn the portable music player volume down. If the problem persists, replace or recharge the batteries in the portable media player.
- Control the portable media player in the same manner when used with headphones, as the auxiliary input jack does not provide control (such as Play or Pause) over the attached portable media player.

PHONE

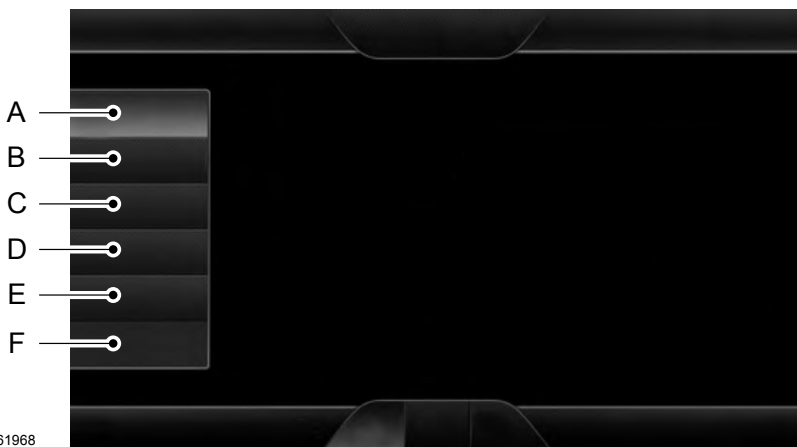

E161968

- A Phone
- B Quick Dial
- C Phonebook
- D History
- E Messaging
- F Settings

MyFord Touch™ (If Equipped)

Hands-free calling is one of the main features of SYNC. Once you pair your phone, you can access many options using the touchscreen or voice commands. While the system supports a variety of features, many are dependent on your cellular phone's functionality.

At a minimum, most cellular phones with Bluetooth wireless technology support the following functions:

- Answering an incoming call.
- Ending a call.
- Using privacy mode.
- Dialing a number.
- Redialing.
- Call waiting notification.
- Caller ID.

Other features, such as text messaging using Bluetooth and automatic phonebook download, are phone-dependent features. To check your phone's compatibility, see your phone's user manual and visit www.SYNCMYRide.com, www.SYNCMYRide.ca or www.syncmaroute.ca.

Pairing Your Phone for the First Time

WARNING



Driving while distracted can result in loss of vehicle control, crash and injury. We strongly recommend that you use extreme caution when using any device that may take your focus off the road. Your primary responsibility is the safe operation of your vehicle. We recommend against the use of any handheld device while driving and encourage the use of voice-operated systems when possible. Make sure you are aware of all applicable local laws that may affect the use of electronic devices while driving.

The first thing you must do to use the phone features of SYNC is to pair your Bluetooth-enabled cellular phone with SYNC. This allows you to use your phone in a hands-free manner.

Note: *Put the transmission in park (P). Switch on your vehicle ignition and the radio.*

1. Touch **Add Phone** in the upper left corner of the touchscreen. **Find SYNC** appears on the screen, and instructs you to begin the pairing process from your device.
2. Make sure that Bluetooth is set to **On** and that your cellular phone is in the proper mode. See your phone's manual if necessary.

Note: *Select **SYNC**, and a six-digit PIN appears on your device.*

3. If prompted to enter a PIN on your device, it does not support Secure Simple Pairing. To pair, enter the PIN displayed on the touchscreen. Skip the next step.
4. When prompted on your phone's display, confirm that the PIN provided by SYNC matches the PIN displayed on your cellular phone.
5. The display indicates when the pairing is successful.

SYNC may prompt you with more phone options. For more information on your phone's capability, see your phone's manual and visit the website.

Pairing Subsequent Phones

Note: *Put the transmission in park (P). Switch on your vehicle ignition and the radio.*

1. Press the **Phone** corner of the touchscreen > **Settings** > **BT Devices** > **Add Device**.

MyFord Touch™ (If Equipped)

2. Make sure that Bluetooth is set to **On** and that your cellular phone is in the proper mode. See your phone's manual if necessary.

Note: Select **SYNC**, and a six-digit PIN appears on your device.

3. If prompted to enter a PIN on your device, it does not support Secure Simple Pairing. To pair, enter the PIN displayed on the touchscreen. Skip the next step.
4. When prompted on your phone's display, confirm that the PIN provided by SYNC matches the PIN displayed on your cellular phone.
5. The display indicates when the pairing is successful.

SYNC may prompt you with more phone options. For more information on your phone's capability, see your phone's manual and visit the website.

Making Calls



Press the voice button on your steering wheel controls. When prompted, say, "Call <name>" or say "Dial", then the desired number.



To end the call or exit phone mode, press and hold the phone button.

Receiving Calls

During an incoming call, an audible tone sounds. Call information appears in the display if it is available.



Accept the call by pressing **Accept** on the touchscreen or by pressing the phone button on your steering wheel controls.

Reject the call by pressing **Reject** on the touchscreen or by pressing and holding the phone button on your steering wheel controls.

Ignore the call by doing nothing. SYNC logs it as a missed call.

Phone Menu Options

Press the top left corner on your touchscreen to select from the following options:

Phone

Touch this button to access the on-screen numerical pad to enter a number and place a call. During an active call, you can also choose to:

- Mute the call.
- Put the call on hold.
- Turn on the privacy feature.
- Join two calls.
- End the call.

Quick Dial

Set up favorite contacts from your phonebook or history folder.

Phonebook

Touch this button to access and call any contacts in your previously downloaded phone book. The system places the entries in alphabetical categories summarized at the top of the screen.

To switch on contact picture settings, if your device supports this feature, press **Phone > Settings > Manage Phonebook > Download photos from Phonebook > On**.

History

After you connect your Bluetooth-enabled phone to SYNC, you can access any previously dialed, received or missed calls. You can also choose to save these to your Favorites or to Quick Dial.

MyFord Touch™ (If Equipped)

Note: *This is a phone-dependent feature. If your phone does not support downloading call history using Bluetooth, SYNC keeps track of calls made with the SYNC system.*

Messaging

Send text messages using your touchscreen. See **Text messaging** later in this section.

Settings

Touch this button to access various phone settings, such as turning Bluetooth on and off, managing your phonebook and more. See **Phone settings** later in this section.

Text Messaging

Note: *Downloading and sending text messages using Bluetooth are phone-dependent features.*

Note: *Certain features in text messaging are speed-dependent and not available when your vehicle is traveling at speeds over 3 mph (5 km/h).*

Note: *SYNC does not download read text messages from your phone.*

You can send and receive text messages using Bluetooth, read them aloud and translate text messaging acronyms, such as LOL.

1. Touch the top left corner of the display to access the **Phone** menu.
2. Select **Messaging**.
3. Choose from the following:
 - Listen (speaker icon).
 - Dial.
 - Send Text.
 - View.
 - Delete.

Composing a Text Message

Note: *This is a speed-dependent feature. It is unavailable when your vehicle is traveling at speeds over 3 mph (5 km/h).*

Note: *Downloading and sending text messages using Bluetooth are phone-dependent features.*

1. Touch the top left corner of the display to access the **Phone** menu.
2. Touch **Messaging > Send Text**.
3. Enter a phone number or choose from your phonebook.
4. You can select from the following options:
 - **Send**, which sends the message as it is.
 - **Edit Text**, which allows you to customize the pre-defined message or create a message on your own.

You can then preview the message, verify the recipient as well as update the message list.

Text message options
I'll call you back in a few minutes.
I just left, I'll be there soon.
Can you give me a call?
I'm on my way.
I'm running a few minutes late.
I'm ahead of schedule, so I'll be there early.
I'm outside.
I'll call you when I get there.
OK
Yes
No

MyFord Touch™ (If Equipped)

Text message options
Thanks
Stuck in traffic.
Call me later.
LOL

Receiving a Text Message

Note: If you select **View** and your vehicle is traveling over 3 mph (5 km/h), the system offers to read the message to you instead of allowing you to view it while driving.

When a new message arrives, an audible tone sounds and the screen displays a pop-up with the caller name and ID, if supported by your phone. You can press:

- **View** to view the text message.
- **Listen** for SYNC to read the message to you.
- **Dial** to call the contact.
- **Ignore** to exit the screen.

Phone Settings

Press **Phone > Settings**.

Bluetooth Devices

Touch this tab to connect, disconnect, add or delete a device, as well as save it as a favorite.

Bluetooth

Touch this tab to turn Bluetooth off or on.

Do Not Disturb

Touch this tab if you want all calls to go directly to your voice mail and not ring in the vehicle. When this feature is on, text message notifications do not ring inside the cabin either.

911 Assist

Turn on or turn off the 911 Assist feature. See **Information** (page 476).

Phone Ringer

Select the ring tone you want to hear when you receive a call. Choose from possible system ring tones, your currently paired phone's ring tone, a beep, text-to-speech or a silent notification.

Text Message Notification

Select a text message notification, if supported by your phone. Choose from possible system alert tones, text-to-speech or silent.

Internet Data Connection

If your phone is compatible, use this screen to adjust your internet data connection. Select to make your connection profile with the personal area network or to switch off your connection. You can also choose to adjust your settings or have the system always connect, never connect when roaming or query on connect. Press **?** for more information.

Manage Phonebook

Touch this button to access features such as automatic phonebook download, re-download your phonebook, add contacts from your phone as well as delete or upload your phonebook.

Roaming Warning

Touch this button to have the system alert you when your phone is in roaming mode.

Phone Voice Commands



Press the voice button on the steering wheel controls. When prompted, say any of the following commands:

MyFord Touch™ (If Equipped)

"PHONE"
"Call"
"Call <name>"
"Call <name> at home"
"Call <name> at work"
"Call <name> on cell"
"Call <name> on other"
"Call voicemail"
"Dial"
"Do not disturb off"
"Do not disturb on"
"Forward text messages"
"Go to hands free"*
"Hold call off"*
"Hold on"*
"Join calls"*
"Listen to text message <#>"
"Listen to text messages"
"Messages"***
"Mute call"*

"PHONE"
"Pair phone"
"Privacy on"*
"Read text message"
"Reply to text messages"
"Turn ringer off"
"Turn ringer on"
"Unmute call"*
"Help"

* This command is only available during an active call.

** If you say "Messages", see the following "Messages" chart for additional commands.

"MESSAGES"
"Call"
"Forward text messages"
"Listen to text message <#>"
"Listen to text messages"
"Reply to text messages"
"Help"

INFORMATION

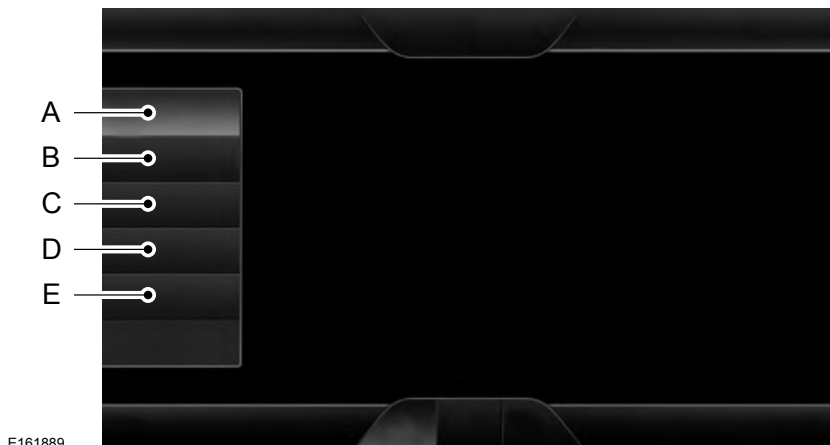

E161889

- A SYNC Services
- B Sirius Travel Link
- C Alerts
- D Calendar
- E SYNC Applications

Under the Information menu, you can access features such as:

- SYNC Services
- Sirius Travel Link
- Alerts
- Calendar
- SYNC Applications

 If your vehicle is equipped with Navigation, press the **Information** button to access these features. If your vehicle is not equipped with Navigation, press the corner of the touchscreen with the green tab.

SYNC Services (If Equipped, United States Only)

Note: SYNC Services varies by trim level and model year and may require a subscription. Traffic alerts and turn-by-turn directions available in select markets. Message and data rates may apply. Ford Motor Company reserves the right to change or discontinue this product service at any time without prior notification or incurring any future obligation.

Note: SYNC Services requires activation before use. Visit www.SYNCMyRide.com to register and check your eligibility for complimentary services. Standard phone and message rates may apply. Subscription may be required. You must also have the active SYNC Services Bluetooth-enabled cellular phone paired and connected to the system in order to connect to, and use, SYNC Services. See **Phone** (page 470).

Note: This feature does not function properly if you have enabled caller ID blocking on your cellular phone. Make sure your cellular phone is not blocking caller ID before using SYNC Services.

Note: The driver is ultimately responsible for the safe operation of the vehicle, and therefore, must evaluate whether it is safe to follow the suggested directions. Any navigation features provided are only an aid. Make your driving decisions based on your observations of local conditions and existing traffic regulations. Do not follow the route suggestions if doing so would result in an unsafe or illegal maneuver, if you would be placed in an unsafe situation, or if you would be directed into an area that you consider unsafe. Maps used by this system may be inaccurate because of errors, changes in roads, traffic conditions or driving conditions.

Note: When you connect, the service uses GPS technology and advanced vehicle sensors to collect your vehicle's current location, travel direction and speed to help provide you with the directions, traffic reports, or business searches you request. Further, to provide the services you request, for continuous improvement, the service may collect and record call details and voice communications. For more information, see SYNC Services Terms and Conditions at www.SYNCMyRide.com. If you do not want Ford or its service providers to collect your vehicle travel information or other information identified in the Terms and Conditions, do not subscribe or use the service.

SYNC Services uses advanced vehicle sensors, integrated GPS technology and comprehensive map and traffic data, to give you personalized traffic reports, precise turn-by-turn directions, business search, news, sports, weather and more. For a complete list of services, or to learn more, please visit www.SYNCMyRide.com.

Connecting to SYNC Services Using Voice Commands



1. Press the voice button.
2. When prompted, say "Services". This initiates an outgoing call to SYNC Services using your paired and connected Bluetooth-enabled cellular phone.
3. Once you connect to the service, follow the voice prompts to request the desired service, such as "Traffic" or "Directions". You can also say, "What are my choices?" to receive a list of available services from which to choose.
4. Say, "Services" to return to the Services main menu or for help, say, "Help".

Connecting to SYNC Services Using the Touchscreen



If your vehicle is equipped with Navigation, press the **Information** button.

If your vehicle is not equipped with Navigation, press the green tab on your touchscreen.

1. Select **Connect to Services** to initiate an outgoing call to SYNC Services using your phone.
2. Once connected, follow the voice prompts to request your desired Service, such as "Traffic" or "Directions". You can also say, "What are my choices?" to receive a list of available services from which to choose.
3. Say, "Services" to return to the Services main menu or for help, say, "Help".

Receiving Turn-by-Turn Directions

1. When connected to SYNC Services, say "Directions" or "Business search". To find the closest business or type of business to your current location, just say "Business search" and then "Search near me". If you need further assistance in finding a location you can say "Operator" at any time within a Directions or Business search to speak with a live operator. The system may prompt you to speak with an operator when it has difficulty matching your voice request. The live operator can assist you by searching for businesses by name or by category, residential

addresses by street address or by name or specific street intersections. Operator Assist is a feature of your SYNC Services subscription. For more information on Operator Assist, visit www.SYNCMyRide.com/support.

2. Follow the voice prompts to select your Destination. After the route download is finished, the phone call automatically ends.

If your vehicle is not equipped with Navigation:

- Turn-by-turn directions appear in the information display, in the status bar of your touchscreen system and on the SYNC Services screen. You also receive driving instructions from audible prompts.
- When on an active route, you can select **Route Summary** or **Route Status** using the touchscreen controls or voice commands to view the **Route Summary Turn List** or the **Route Status ETA**. You can also turn voice guidance on or off, cancel the route or update the route.

If you miss a turn, SYNC automatically asks if you want the route updated. Just say, "Yes" when prompted and the system delivers a new route to your vehicle.

If your vehicle is equipped with Navigation, SYNC Services downloads your requested destination to the navigation system. The navigation system then calculates the route and provides driving instructions. See **Navigation** (page 488).

Disconnecting from SYNC Services

1. Press and hold the hang-up phone button on the steering wheel.
2. Say "Good-bye" from the SYNC Services main menu.

MyFord Touch™ (If Equipped)

SYNC Services quick tips	
Personalizing	You can personalize your Services feature to provide quicker access to your most used or favorite information. You can save address points, such as work or home. You can also save favorite information like sports teams, such as Detroit Lions, or a news category. You can learn more about personalization by logging onto www.SYNCMyRide.com .
Push to interrupt	Press the voice button at any time (while connected to SYNC Services) to interrupt a voice prompt or an audio clip (such as a sports report) and say your voice command.
Portable	Your subscription is associated with your Bluetooth-enabled cellular phone number, not your VIN (Vehicle Identification Number). You can pair and connect your phone to any vehicle equipped with SYNC Services and continue enjoying your personalized services.

SYNC Services Voice Commands



When a route has been downloaded (non-navigation systems), press the voice button on the steering wheel controls. When prompted, say any of the following commands:

"SERVICES"
"Cancel route"
"Navigation voice off"
"Navigation voice on"
"Next turn"
"Route status"
"Route summary"
"Services"
"Update route"
"Help"

Sirius Travel Link (If Equipped)

WARNING



Driving while distracted can result in loss of vehicle control, crash and injury. We strongly recommend that you use extreme caution when using any device that may take your focus off the road. Your primary responsibility is the safe operation of your vehicle. We recommend against the use of any handheld device while driving and encourage the use of voice-operated systems when possible. Make sure you are aware of all applicable local laws that may affect the use of electronic devices while driving.

Note: *In order to use Sirius Travel Link, your vehicle must be equipped with navigation and your navigation SD card must be in the SD card slot.*

Note: *This feature is only available in the United States.*

MyFord Touch™ (If Equipped)

Note: A paid subscription is required to access and use these features. Go to www.siriusxm.com/travellink for more information.

Note: Visit www.siriusxm.com/traffic and click on Coverage map and details for a complete listing of all traffic areas covered by Sirius Travel Link.

Note: Neither Sirius nor Ford is responsible for any errors or inaccuracies in the Sirius Travel Link services or its use in vehicles.

When you subscribe to Sirius Travel Link, it can help you locate the best gas prices, find movie listings, get current traffic alerts, view the current weather map, get accurate ski conditions and see scores to current sports games.



If your vehicle is equipped with Navigation, touch the I (Information) button to access these features. If your vehicle is not equipped with Navigation, touch the corner of the touchscreen with the green tab.

Traffic On Route and Traffic Nearby

Touch these buttons to identify traffic incidents on your route, nearby your vehicle's current location or near any of your favorite places, if programmed.

Fuel Prices

Touch this button to view fuel prices at stations close to your vehicle's location or on an active navigation route.

Movie Listings

Touch this button to view nearby movie theaters and their show times, if available.

Weather

Touch this button to view the nearby weather, current weather, or the five day forecast for the chosen area. Select **Map** to see the weather map, which can show storms, radar information, charts and winds. Select **Area** to select from a listing of weather locations.

Sports Info

Touch this button to view scores and schedules from a variety of sports. You can also save up to 10 favorite teams for easier access. The score automatically refreshes when a game is in progress.

Ski Conditions

Touch this button to view ski conditions for a specific area.

Sirius Travel Link Voice Commands



Press the voice button on the steering wheel controls. When prompted, say any of the following commands:

"SIRIUS TRAVEL LINK"
"5-day weather forecast"
"Fuel prices"
"Movie listings"
"Sports headlines"
"Sports schedules"
"Sports scores"
"Traffic"
"Weather"

MyFord Touch™ (If Equipped)

"SIRIUS TRAVEL LINK"
"Weather map"
"Help"

* If you say "Sports headlines", "Sports schedules" or "Sports scores", you can then say any of the commands in the following chart.

Sports-related commands
"Baseball"
"College basketball"
"College football"
"Golf"
"MLS"
"My teams"
"NBA"
"NFL"
"NHL"
"WNBA"
"Help"

Additional sports-related voice commands
"Baseball headlines"
"Baseball schedule"
"Baseball scores"
"College basketball headlines"
"College basketball schedule"
"College basketball scores"
"College football headlines"

Additional sports-related voice commands
"College football schedule"
"College football scores"
"Golf headlines"
"Golf leaderboard"
"Golf schedule"
"MLS headlines"
"MLS schedule"
"MLS scores"
"Motor sports headlines"
"Motor sports order"
"Motor sports schedule"
"My team headlines"
"My teams schedule"
"My teams scores"
"NBA headlines"
"NBA schedule"
"NBA scores"
"NFL headlines"
"NFL schedule"
"NFL scores"
"NHL headlines"
"NHL schedule"
"NHL scores"
"WNBA headlines"

Additional sports-related voice commands

"WNBA schedule"

"WNBA scores"

"Help"

Alerts

 If your vehicle is equipped with Navigation, touch the I (Information) button to access these features. If your vehicle is not equipped with Navigation, touch the corner of the touchscreen with the green tab.

Press **Alerts**, and then choose from any of the following services:

- **View** the complete message.
- **Delete** the message.
- **Delete All** messages.

This screen displays any system messages (such as an SD card fault).

Note: The system alerts you to any messages by turning the information icon yellow. After you read or delete the messages, the icon returns to white.

Calendar

 If your vehicle is equipped with Navigation, touch the I (Information) button to access these features. If your vehicle is not equipped with Navigation, touch the corner of the touchscreen with the green tab.

Press **Calendar**. You can view the current calendar by day, week or month.

911 Assist (If Equipped)

WARNINGS



Unless the 911 Assist setting is set on before a crash, the system will not dial for help, which could delay response time, potentially increasing the risk of serious injury or death after a crash.



Do not wait for 911 Assist to make an emergency call if you can do it yourself. Dial emergency services immediately to avoid delayed response time, which could increase the risk of serious injury or death after a crash. If you do not hear 911 Assist within five seconds of the crash, the system or phone may be damaged or non-functional.



Always place your phone in a secure location in your vehicle so it does not become a projectile or damaged in a crash. Failure to do so may cause serious injury to someone or damage the phone, which could prevent 911 Assist from working properly.

Note: The SYNC 911 Assist feature must be set on prior to the incident.

Note: Before setting this feature on, make sure that you read the 911 Assist Privacy Notice later in this section for important information.

Note: If any user turns 911 Assist on or off, that setting applies for all paired phones. If 911 Assist is turned off, either a voice message plays or a display message (or icon) comes on (or both) when your vehicle is started after a previously paired phone connects.

Note: Every phone operates differently. While SYNC 911 Assist works with most cellular phones, some may have trouble using this feature.

If a crash deploys an airbag, excluding knee airbags and rear inflatable safety belts where fitted or activates the fuel pump shut-off, your SYNC-equipped vehicle may be able to contact emergency services by dialing 911 through a paired and connected Bluetooth-enabled phone. You can learn more about the 911 Assist feature, visit www.SYNCMyRide.com, www.SYNCMyRide.ca or www.syncmaroute.ca.

See **Supplementary Restraints System** (page 43). Important information regarding airbag deployment is in this chapter.

See **Roadside Emergencies** (page 277). Important information regarding the fuel pump shut-off is in this chapter.

Setting 911 Assist On



If your vehicle is equipped with Navigation, touch the **i** (Information) button to access these features. If your vehicle is not equipped with Navigation, touch the corner of the touchscreen with the green tab.

Touch **Apps** > **911 Assist**, then select **On**.



You can also access 911 Assist by:

- Pressing the Settings icon > **Settings** > **Phone** > **911 Assist**, or
- Pressing the Settings icon > **Help** > **911 Assist**.

To make sure that 911 Assist works properly:

- SYNC must be powered and working properly at the time of the incident and throughout feature activation and use.
- The 911 Assist feature must be set on prior to the incident.

- You must pair and connect a Bluetooth-enabled and compatible phone to SYNC.
- A connected Bluetooth-enabled phone must have the ability to make and maintain an outgoing call at the time of the incident.
- A connected Bluetooth-enabled phone must have adequate network coverage, battery power and signal strength.
- The vehicle must have battery power and be located in the United States, Canada or in a territory in which 911 is the emergency number.

In the Event of a Crash

Not all crashes deploy an airbag or activate the fuel pump shut-off (which would trigger 911 Assist); however, SYNC tries to contact emergency services if 911 Assist triggers. If a connected phone sustains damage or loses connection to SYNC, SYNC searches for, and tries to connect to, any available previously paired phone and tries to make the call to 911.

Before making the call:

- SYNC provides a short window of time (approximately 10 seconds) to cancel the call. If you fail to cancel the call, SYNC attempts to dial 911.
- SYNC says the following, or a similar message: "SYNC will attempt to call 911, to cancel the call, press Cancel on your screen or press and hold the phone button on your steering wheel."

If you do not cancel the call, and SYNC makes a successful call, a pre-recorded message plays for the 911 operator, and then the occupant(s) in your vehicle is able to talk with the operator. Be prepared to provide your name, phone number and location immediately, because not all 911 systems are capable of receiving this information electronically.

911 Assist May Not Work If:

- Your cellular phone or 911 Assist hardware sustains damage in a crash.
- The vehicle's battery or the SYNC system has no power.
- The phone(s) previously paired or connected to the system are thrown from the vehicle.

911 Assist Privacy Notice

When you turn on 911 Assist, it may disclose to emergency services that your vehicle has been in a crash involving the deployment of an airbag or activation of the fuel pump shut-off. Certain versions or updates to 911 Assist may also be capable of electronically or verbally disclosing to 911 operators your vehicle location or other details about your vehicle or crash to assist 911 operators to provide the most appropriate emergency services. If you do not want to disclose this information, do not turn the feature on.

Vehicle Health Report (If Equipped, United States Only)

WARNING



Always follow scheduled maintenance instructions, regularly inspect your vehicle, and seek repair for any damage or problem you suspect. Vehicle Health Report supplements, but cannot replace, normal maintenance and vehicle inspection. Vehicle Health Report only monitors certain systems electronically monitored by your vehicle and will not monitor or report the status of any other system, (such as brake lining wear). Failure to perform scheduled maintenance and regularly inspect your vehicle may result in vehicle damage and serious injury.

Note: Your Vehicle Health Report feature requires activation prior to use. Visit www.SYNCMYRIDE.com to register. There is no fee or subscription associated with Vehicle Health Report, but you must register to use this feature.

Note: This feature may not function properly if you have enabled caller ID blocking on your cellular phone. Before running a report, review the Vehicle Health Report Privacy Notice.

Note: In order to allow a break-in period for your vehicle, you may not be able to create a Vehicle Health Report until your vehicle odometer has reached 200 miles.

Note: Cellular phone and SMS charges may apply when making a report.

Register for Vehicle Health Report and set your report preferences at www.SYNCMYRIDE.com. After registering, you can request a Vehicle Health Report (inside your vehicle). Return to your account at www.SYNCMYRIDE.com to view your report. You can also choose for SYNC to remind you automatically to run reports at specific mileage intervals. Cellular phone airtime usage may apply when reporting.

The system allows you to check your vehicle's overall health in the form of a diagnostic report card. The Vehicle Health Report contains valuable information, for example:

- Vehicle diagnostic information.
- Scheduled maintenance.
- Open recalls and Field Service Actions.
- Items noted during vehicle inspections by your authorized dealer that still need servicing.

Making a Report



If you want to run a report by using the touchscreen, touch **Apps > Vehicle Health Report.**

MyFord Touch™ (If Equipped)



To run a report by voice command, press the voice button on the steering wheel and, when prompted, say "Vehicle health report".

Vehicle Health Report Privacy Notice

When you create a Vehicle Health Report, Ford Motor Company may collect your cellular phone number (to process your report request) and diagnostic information about your vehicle. Certain versions or updates to Vehicle Health Report may also collect more vehicle information. Ford may use your vehicle information it collects for any purpose. If you do not want to disclose your cellular phone number or vehicle

information, do not run the feature or set up your Vehicle Health Report profile at www.SYNCMYRide.com. See www.SYNCMYRide.com (Vehicle Health Report Terms and Conditions, and Privacy Statement) for more information.

CLIMATE

Touch the lower right corner on the touchscreen to access your climate control features. Depending on your vehicle line and option package, your climate screen may look different from this screen.

Note: You can switch temperature units between Fahrenheit and Celsius. See **Settings** (page 443).

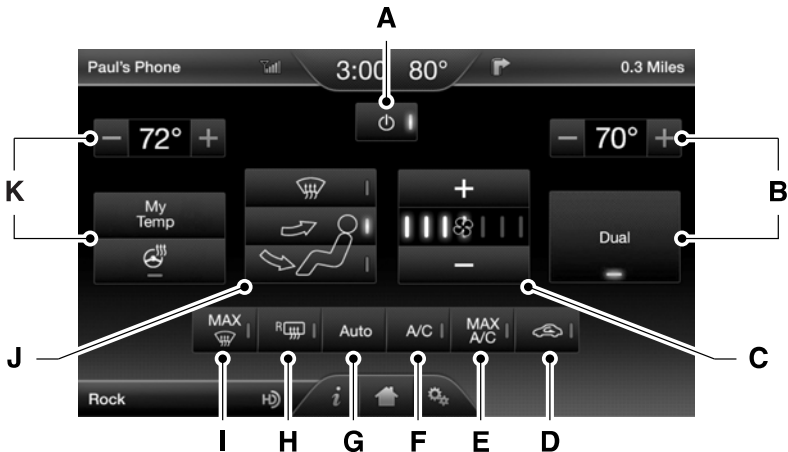

E212081

A Power: Touch the button to turn the system on and off. Switching off the climate control system prevents outside air from entering the vehicle.

B Passenger settings:

Touch the **+** or **-** to increase or decrease the air temperature on the passenger side of the vehicle.

MyFord Touch™ (If Equipped)

Touch **DUAL** to turn separate passenger side temperature controls off and on. When you turn off DUAL, the passenger side temperature changes to match the driver side temperature.

Note: The passenger side temperature and the **DUAL** indicator automatically turn on when the passenger is adjusting their temperature control.

- C **Fan speed:** Touch **+** or **-** to increase or decrease the volume of air circulated in your vehicle.

Note: When the system is controlling the fan speed automatically, all the fan speed indicators turn off.

- D **Recirculated air:** Touch the button to switch between outside air and recirculated air. When you select recirculated air, the air currently in the passenger compartment recirculates. This may reduce the time needed to cool the interior (when used with **A/C**) and may reduce unwanted odors from entering your vehicle.

Note: Recirculated air may turn off automatically (or be prevented from turning on) in all airflow modes except **MAX A/C** to reduce risk of fogging. Recirculated air may also turn on and off automatically in **Panel** or **Panel and Floor** airflow modes during hot weather in order to improve cooling efficiency.

- E **MAX A/C:** Touch the button to maximize cooling. Recirculated air flows through the instrument panel vents, air conditioning automatically turns on, and the fan automatically adjusts to the highest speed.

- F **A/C:** Touch the button to turn air conditioning compressor on or off. Use air conditioning with recirculated air to improve cooling performance and efficiency.

Note: In certain conditions (such as when using Max Defrost), the air conditioning compressor may continue to operate even after you switch off the air conditioning with the **A/C** button.

- G **AUTO:** Touch the button to turn on automatic operation. Select the desired temperature using the temperature control. The system adjusts fan speed, air distribution, air conditioning operation, and selects outside air or recirculated air to heat or cool the vehicle in order to maintain the desired temperature. You can also use the **AUTO** button to turn off dual zone operation by touching and holding the button for more than two seconds.

- H **Heated rear window:** Turns the heated rear window on and off. See **Heated Windows and Mirrors** (page 137).

- I **MAX Defrost:** Touch the button to maximize defrosting. Outside air flows through the windshield vents, fan automatically adjusts to the highest speed and the temperature dial returns to the full heat position. You can use this setting to defog or clear a thin covering of ice from the windshield. The heated rear window also automatically turns on when you select MAX Defrost.

Note: To prevent window fogging, you cannot select recirculated air when MAX Defrost is on.

MyFord Touch™ (If Equipped)

J **Air distribution control:** Touch these buttons to turn airflow from the windshield, instrument panel, or footwell vents on or off. The system can distribute air through any combination of these vents.

K **Driver settings:**

Touch the **+** or **-** to increase or decrease the air temperature on the driver side of the vehicle.

Touch **MyTemp** to select your preset temperature setpoint. Touch and hold **MyTemp** to save a new preset temperature setpoint.

Touch the heated steering wheel icon to turn the heated steering wheel on and off (if equipped).

Note: If your vehicle is equipped with a wood-trimmed steering wheel, it does not heat between the 10 o'clock and 2 o'clock positions.

Climate Control Voice Commands

Note: The fan speed will automatically decrease when you start a voice command session or phone call through SYNC. This feature is dependent on the current climate control settings and helps to reduce the background noise in the vehicle. The fan speed returns to normal when the voice session has ended. You can adjust the fan speed manually during this time by using the fan button or knob to reach the desired setting. To disable or enable automatic fan speed, press and hold the **AC** and **Recirculated air** buttons at the same time. Release the buttons and immediately increase the fan speed.



Press the voice button on the steering wheel controls. When prompted, say any of the following commands:

Climate control commands
"Climate automatic"
"Climate my temperature"
"Climate off"

Climate control commands
"Climate on"
"Climate temperature <15.5-29.5> degrees"
"Climate temperature <60-85> degrees"
"Help"

There are additional climate control commands but in order to access them, you have to say "Climate" first. When the system is ready to listen, you may say any of the following commands:

"CLIMATE"
"A/C off"
"A/C on"
"Automatic"
"Defrost off"
"Defrost on"
"Dual off"
"Floor on"
"Fan decrease"
"Fan increase"

MyFord Touch™ (If Equipped)

"CLIMATE"
"MAX A/C off"
"MAX A/C on"
"My temp"
"Off"
"On"
"Panel floor on"
"Panel off"
"Panel on"
"Rear defrost off"
"Rear defrost on"
"Recirc off"
"Recirc on"
"Temperature"*
"Temperature <15.5-29.5> degrees"
"Temperature <60-85> degrees"
"Temperature decrease"
"Temperature high"
"Temperature increase"
"Temperature low"
"Windshield floor on"
"Help"

* If you say "Temperature", you can then say any of the commands in the following chart.

"TEMPERATURE"
"<15.5-29.5> degrees"
"<60-85> degrees"
"High"
"Low"
"Help"

NAVIGATION

Note: The navigation SD card must be in the SD card slot to operate the navigation system. If you need a replacement SD card, see an authorized dealer.

Note: The SD card slot is spring-loaded. To remove the SD card, just push the card in and release it. Do not attempt to pull the card out to remove it; this could cause damage.

Your navigation system is comprised of two main features, destination mode and map mode.

To set a destination, press the green corner of your touchscreen, then the **Dest** button when it appears. See **Setting a Destination** later in this chapter.

To view the navigation map and your vehicle's current location, touch the green bar in the upper right-hand corner of the touchscreen, or, press **Dest**, then **Map**. See **Map mode** later in this chapter.

Setting a Destination

Press the green corner of your touchscreen, then the **Dest** button when it appears. Choose any of the following:

MyFord Touch™ (If Equipped)

Destination
My Home
Favorites
Previous Destinations
Point of Interest
Emergency
Street Address
Intersection
City Center
Map
Edit Route
Cancel Route

1. Enter the necessary information into the highlighted text fields (in any order). For address destination entry, the **Go!** button appears once you enter all the necessary information. Pressing the **Go!** button makes the address location appear on the map. If you choose **Previous Destination**, the last 20 destinations you have selected appear.
2. Select **Set as Dest** to make this your destination. You can also choose to set this as a waypoint (have the system route to this point on the way to your current destination) or save it as a favorite. The system considers any **Avoid Areas** selections in its route calculation.
3. Choose from up to three different types of routes, and then select **Start Route**.

- **Fastest:** Uses the fastest moving roads possible.
- **Shortest:** Uses the shortest distance possible.
- **Eco Route:** Uses the most fuel-efficient route.

You can cancel the route or have the system demo the route for you. Select **Route Prefs** to set route preferences like avoiding freeways, tollroads, ferries and car trains as well as to use or not use high-occupancy vehicle lanes. (High-occupancy vehicle lanes are also known as carpool or diamond lanes. People who ride in buses, vanpools or carpools use these lanes.)

Note: *If your vehicle is on a recognized road and you do not press the **Start Route** button, the system defaults to the Fastest Route option and begins guidance.*

During route guidance, you can press the talking bubble icon that appears in the upper right navigation corner (green bar) if you want the system to repeat route guidance information. When the system repeats the last guidance instruction, it updates the distance to the next guidance instruction, since it detects when the vehicle is moving.

Point of Interest (POI) Categories

Main categories
Food/Drink & Dining
Travel & Transportation
Financial
Emergency
Community
Health & Medicine
Automotive

MyFord Touch™ (If Equipped)

Main categories
Shopping
Entertainment & Arts
Recreation & Sports
Government
Domestic Services

Subcategories
Restaurant
Golf
Parking
Home & Garden
Personal Care Services
Auto Dealership
Govt Office
Public Transit
Education

To expand these listings, press the + in front of the listing.

The system also allows you to sort alphabetically, by distance or by cityseekr listings (if available).

cityseekr

Note: *cityseekr point of interest (POI) information is limited to approximately 912 cities (881 in the United States, 20 in Canada and 11 in Mexico).*



cityseekr, when available, is a service that provides more information about certain points of interest such as restaurants, hotels and attractions.

When you have selected a point of interest, the location and information appear, such as address and phone number. If cityseekr lists the point of interest, more information is available, such as a brief description, check-in and checkout times or restaurant hours.

Press **More Information** for a longer review, a list of services and facilities, the average room or meal price as well as the website. This screen displays the point of interest icon such as:



Hotel



Coffeehouse



Food & Drink



Nightlife



Attraction



This icon appears when your selection exists in multiple categories within the system.

When you are viewing more information for hotels, cityseekr also tells you if the hotel has certain services and facilities using icons, such as:

- Restaurant.
- Business center.
- Handicap facilities.

- Laundry.
- Refrigerator.
- 24 hour room service.
- Fitness center.
- Internet access.
- Pool.
- Wi-fi.

For restaurants, cityseekr can provide information such as star rating, average cost, review, handicap access, hours of operation, and website address.

For hotels, cityseekr can provide information such as star rating, price category, review, check-in and checkout times, hotel service icons and website address.

Setting Your Navigation Preferences

Select settings for the system to take into account when planning your route.



Press the Settings icon > **Settings > Navigation.**

Map Preferences

Breadcrumbs

Display your vehicle's previously traveled route with white dots. Switch this feature **ON** or **OFF**.

Turn List Format

Have the system display your turn list **Top to Bottom** or **Bottom to Top**.

Parking POI Notification

Set the automatic parking point of interest notification. Switch this feature **ON** or **OFF**. When parking point of interest notification is on, the icons display on the map when you get close to your destination. This may not be very useful in dense areas, and may clutter the map when other points of interest display.

Route Preferences

Preferred Route

Choose to have the system display the Shortest, Fastest or most Ecological route first. If you set **Always Use Preferred Route to Yes**, the system uses the selected route type to calculate only one route to the desired destination.

Always Use Preferred Route

Bypass route selection in destination programming. The system only calculates one route based on preferred route setting.

Eco Time Penalty

Select a low, medium or high cost for the calculated Eco Route. The higher the setting, the longer the time allotment is for the route.

Avoid

These features allow you to choose to have the system avoid freeways, toll roads, ferries and car trains when planning your route. Switch these features **ON** or **OFF**.

Use HOV Lanes

Have the system use high-occupancy vehicle lanes, if available, when planning your route.

Navigation Preferences

Guidance Prompts

Have the system use **Voice & Tones** or **Tone Only** on your programmed route.

Auto - Fill State/Province

Have the system automatically fill in the state and province based on the information already entered into the system. Switch this feature **ON** or **OFF**.

Traffic Preferences

Avoid Traffic Problems

Choose how you want the system to handle traffic problems along your route.

- **Automatic:** Have the system reroute you to avoid traffic incidents that develop and impact the current route. The system does not provide a traffic alert notification.
- **Manual:** Have the system always provide a traffic alert notification for traffic incidents along the planned route. You have a choice to accept or ignore the notification before making the route deviation.

Traffic Alert Notification

Have the system display traffic alert notifications.

Other traffic alert features allows you to turn on certain, or all, traffic icons on the map such as road work, incident, accidents and closed roads. Scroll down to view all the different types of alerts. Switch these features **ON** or **OFF**.

Avoid Areas

Choose areas which you want the system to avoid when calculating a route for you.

Press **Add** to program an entry. Once you make a selection, the system tries to avoid the area(s) if possible for all routes. To delete a selection, choose the listing on the screen. When the screen changes to **Avoid Areas Edit**, you can press **Delete** at the bottom right of the screen.

Map Mode

Press the green bar in the upper right area of the touchscreen to view map mode. Map mode shows advanced viewing comprised of both 2D city maps as well as 3D landmarks (when available).

2D city maps show detailed outlines of buildings, visible land use and land elements and detailed railway infrastructure for the most essential cities around the globe. These maps also contain features, such as town blocks, building footprints and railways.

3D landmarks appear as clear, visible objects that are typically recognizable and have a certain tourist value. The 3D landmarks appear in 3D map mode only. Coverage varies and improves with updated map releases.



Change the appearance of the map display by repeatedly pressing the arrow button in the upper left corner of the screen. It toggles between three different map modes: Heading up, North up and 3D.



Heading up (2D map) always shows the direction of forward travel to be upward on the screen. This view is available for map scales up to 2.5 miles (4 kilometers). The system remembers this setting for larger map scales, but shows the map in North up only. If the scale returns below this level, the system restores Heading up.

MyFord Touch™ (If Equipped)



North up (2D map) always shows the northern direction to be upward on the screen.



3D map mode provides an elevated perspective of the map. This viewing angle can be adjusted and the map can be rotated 180 degrees by touching

the map twice, and then dragging your finger along the shaded bar with arrows at the bottom of the map.

View switches between full map, street list and exit view in route guidance.

Menu displays a pop-up box that allows direct access to navigation settings, View/Edit Route, SIRIUS Travel Link, Guidance Mute and Cancel Route.



Press the speaker button on the map to mute route guidance. When the light on the button illuminates, the feature is on. The speaker button appears on the map only when route guidance is active.



Re-center the map by pressing this icon whenever you scroll the map away from your vehicle's current location.

Auto Zoom

Press the green bar to access map mode, then select the **+** or **-** zoom button to bring up the zoom level and Auto buttons on the touchscreen. When you press **Auto**, Auto Zoom turns on and **Auto** displays in the bottom left corner of the screen in the map scale. The map zoom level then synchronizes with vehicle speed. The slower your vehicle is traveling, the farther the map zooms in; the faster your vehicle is traveling, the farther the map zooms out. To switch off the feature, just press the **+** or **-** button again.

In 3D mode, rotate the map view by swiping your finger across the shaded bar with the arrows.

The ETA box under the zoom buttons appears when a route is active and displays the distance and time to your destination. If the button is pressed, a pop up appears with the destination listed (and waypoint if applicable) along with mileage and time to destination. You may also select to have either the estimated time to reach your destination or your estimated arrival time.

Map Icons



Vehicle mark shows the current location of your vehicle. It stays in the center of the map display, except when in scroll mode.



Scroll cursor allows you to scroll the map; the fixed icon is in the center of the screen. The map position closest to the cursor is in a window on the top center part of the screen.



Address book entry default icon(s) indicates the location on the map of an address book entry. This is the default symbol shown after the entry has been stored to the Address Book by any method other than the map. You can select from any of the 22 icons available. You can use each icon more than once.



Home indicates the location on the map currently stored as the home position. You can only save one address from the Address Book as your Home entry. You cannot change this icon.



POI (Point Of Interest) icons

indicate locations of any point of interest categories you choose to display on the map. You can choose to display three point of interest categories on the map at one time.



Starting point indicates the starting point of a planned route.



Waypoint indicates the location of a waypoint on the map. The number inside the circle is different for each waypoint and represents the position of the waypoint in the route list.



Destination symbol indicates the ending point of a planned route.



Next maneuver point indicates the location of the next turn on the planned route.



No GPS symbol indicates that insufficient GPS satellite signals are available for accurate map positioning. This icon may display under normal operation in an area with poor GPS access.

Quick-touch Buttons

When in map mode, touch anywhere on the map display to access the following options:

Set as Dest

Touch this button to select a scrolled location on the map as your destination. You may scroll the map by pressing your index finger on the map display. When you reach the desired location, simply let go and then touch **Set as Dest**.

Set as Waypoint

Touch this button to set the current location as a waypoint.

Save to Favorites

Touch this button to save the current location to your favorites.

POI Icons

Touch this button to select icons to display on the map. You can select up to three icons to display on the map at the same time. Turn these **ON** or **OFF**.

Cancel Route

Touch this button to cancel the active route.

View/Edit Route

Access these features when a route is active:

- View Route
- Edit Destination/Waypoints
- Edit Turn List
- Detour
- Edit Route Preferences
- Edit Traffic Preferences
- Cancel Route.

Nokia is the digital map provider for the navigation application. If you find map data errors, you may report them directly to Nokia by going to <http://mapreporter.navteq.com>. Nokia evaluates all reported map errors and responds with the result of their investigation by e-mail.

MyFord Touch™ (If Equipped)

Navigation Map Updates

Annual navigation map updates are available for purchase through your dealership, by calling 1-866-4NAVTEQ (1-866-462-8837) (in Mexico, call 01-800-557-5539) or going to www.navigation.com/sync. You need to specify the make and model of your vehicle to determine if there is an update available.

Navigation Voice Commands



When in navigation mode, press the voice button on the steering wheel controls. After the tone, say any of the following commands:

Navigation system voice commands
"Cancel next waypoint" ¹
"Cancel route" ¹
"Destination" ²
"Destination <nametag>"
"Destination <POI category>"
"Destination favorites"
"Destination home"
"Destination intersection"
"Destination nearest <POI category>"
"Destination nearest POI"
"Destination play nametags"
"Destination POI"
"Destination POI category"
"Destination previous destination"
"Destination street address"
"Detour" ¹

Navigation system voice commands
"Navigation" ³
"Navigation voice volume decrease"
"Navigation voice volume increase"
"Repeat instruction" ¹
"Show 3D"
"Show heading up"
"Show map"
"Show north up"
"Show route" ¹
"Show turn list" ¹
"Voice guidance off"
"Voice guidance on"
"Where am I?"
"Zoom in"
"Zoom out"
"Help"

¹ These commands are only available when a navigation route is active.

² If you say "Destination", you can then say any command in the following "Destination" chart.

³ If you say "Navigation", you can then say any command in the following "Navigation" chart.

"DESTINATION"
"<nametag>"
"<POI category>"
"Favorites"

MyFord Touch™ (If Equipped)

"DESTINATION"
"Home"
"Intersection"
"Nearest <POI category>"
"Nearest POI"
"Play nametags"
"POI category"
"Previous destination"
"Street address"
"Help"

One-shot Destination Street Address

When you say either "Navigation destination street address" or "Destination street address", the system asks you to say the full address. The system displays an example on-screen. You can then speak the address naturally, such as "One two three four Main Street, Anytown".

"NAVIGATION"
"Destination"*
"Zoom city"
"Zoom country"
"Zoom minimum"
"Zoom maximum"
"Zoom province"
"Zoom state"
"Zoom street"
"Zoom to <distance>"
"Help"

* If you say "Destination", you can then say any command in the "Destination" chart.

Accessories

For a complete listing of the accessories that are available for your vehicle, please contact your authorized dealer or visit our online store at:

Web Address
www.Accessories.Ford.com

You can also visit:

Web Address
www.Ford.ca

Ford Accessories are available for your vehicle through an authorized Ford dealer. Ford Motor Company repairs or replaces any properly authorized dealer-installed Ford Genuine Accessory found to be defective in factory-supplied materials or workmanship during the warranty period, as well as any component damaged by the defective accessories. Ford Motor Company will warrant your accessory through the warranty that provides the greatest benefit:

- 24 months, unlimited mileage.
- The remainder of your new vehicle limited warranty.

Contact an authorized dealer for details and a copy of the warranty.

Exterior style

- Hood deflector.
- Chrome exhaust tips.
- Side window deflectors.
- Running boards.
- Splash guards.
- Custom graphics*.

Interior style

- Ambient lighting.
- Floor mats.
- Electrochromatic compass/temperature interior mirror.
- Leather-trimmed interior seating*.

Lifestyle

- Smoker's package.
- Bedliners and bedmats.
- Bed ramps.
- Bed side step.
- Towing mirrors.
- Bed extender.
- Tonneau covers*.
- Interior cargo organization and management.
- Racks and carriers*.
- Truck bed camping tent*.
- Sportliner cargo liner*.
- Rear-seat entertainment*.
- Trailer brake controller.
- Hitch balls and towbars.
- Truck bed cargo organization and management.
- Trailer hitches, wiring harnesses and accessories.

Peace of mind

- Keyless entry keypad.
- Vehicle security systems.
- Protective seat covers*.
- Locking gas plug for capless fuel system.
- Bumper- and hitch-mounted parking sensors*.
- Remote start.
- Wheel locks.

Accessories

- Wheel well liners.
- Bed hooks*:
- Back-up alarm*:
- Tool or cargo boxes*:

*Ford Licensed Accessory. The accessory manufacturer designs, develops and therefore warrants Ford Licensed Accessories, and does not design or test these accessories to Ford Motor Company engineering requirements. Contact an authorized Ford dealer for the manufacturer's limited warranty details, and request a copy of the Ford Licensed Accessories product limited warranty from the accessory manufacturer.

For maximum vehicle performance, keep the following information in mind when adding accessories or equipment to your vehicle:

- When adding accessories, equipment, passengers and luggage to your vehicle, do not exceed the total weight capacity of the vehicle or of the front or rear axle (GVWR or GAWR as indicated on the Safety Compliance Certification label). Ask an authorized dealer for specific weight information.
- The Federal Communications Commission (FCC) and Canadian Radio Telecommunications Commission (CRTC) regulate the use of mobile communications systems that are equipped with radio transmitters, for example, two-way radios, telephones and theft alarms. Any such equipment installed in your vehicle should comply with Federal Communications Commission (FCC) and Canadian Radio Telecommunications Commission (CRTC) regulations and should be installed only by an authorized dealer.

- Mobile communications systems may harm the operation of your vehicle, particularly if their manufacturer did not design them specifically for automotive use.
- If you or an authorized Ford dealer add any non-Ford electrical or electronic accessories or components to your vehicle, you may adversely affect battery performance and durability, and may adversely affect the performance of other electrical systems in the vehicle.

Extended Service Plan (ESP)

PROTECT YOURSELF FROM THE RISING COST OF VEHICLE REPAIRS WITH A FORD EXTENDED SERVICE PLAN.

EXTENDED SERVICE PLAN (U.S. Only)

More than 32 million Ford owners have discovered the powerful protection of Ford Extended Service Plan. It is the extended service plan backed by Ford Motor Company, and provides peace of mind protection beyond the New Vehicle Limited Warranty coverage.

Ford ESP Can Quickly Pay for Itself

One service bill – the cost of parts and labor – can easily exceed the price of your Ford Extended Service Plan. With Ford ESP you minimize your risk for unexpected repair bills and rising repair costs.

Up to 1,000+ Covered Vehicle Components

There are four core Extended Service Plans with different levels of coverage. Ask your authorized dealer for details.

1. PremiumCARE - Our most comprehensive coverage. With over 1,000 covered components, this plan is so complete that we generally only discuss what's not covered.
2. ExtraCARE - Covers 113 components, and includes many high-tech items.
3. BaseCARE - Covers 84 components.
4. PowertrainCARE - Covers 29 critical components.

Ford Extended Service Plan is honored by all authorized Ford dealers in the U.S., Canada and Mexico. It is the extended service plan authorized and backed by Ford Motor Company.

That means you get:

- Reliable, quality service at any Ford or Lincoln dealership
- Repairs performed by factory trained technicians, using genuine parts

Rental Car Reimbursement

1st day Rental Benefit

You take advantage of replacement transportation if your vehicle is at your authorized dealer for same day covered repairs.

Extended Rental Benefits

If your vehicle is kept overnight for covered repairs, you are eligible for rental car coverage, including bumper to bumper warranty repairs, and Field Service Actions.

Roadside Assistance

Exclusive 24/7 roadside assistance, including:

- Towing, flat-tire change and battery jump starts
- Out of fuel and lock-out assistance.
- Travel expense reimbursement for lodging, meals and rental car.
- Destination assistance for taxi, shuttle, rental car coverage and emergency transportation.

Transferable Coverage

If you sell your vehicle before your Ford Extended Service Plan coverage expires, you can transfer any remaining coverage to the new owner. Whenever you sell your vehicle, prospective buyers may have a higher degree of confidence that vehicle was properly maintained with Ford ESP, thereby improving resale value.

Extended Service Plan (ESP)

Avoid the Rising Cost of Properly Maintaining Your Vehicle!

Ford Extended Service Plan also offers a Premium Maintenance Plan that covers all scheduled maintenance, and selected wear items. The coverage is prepaid, so you never have to worry about affording your vehicle's maintenance. It covers regular checkups, routine inspections, preventive care and replacement of select items that require periodic attention for normal wear:

- Windshield wiper blades.
- Spark plugs.
- The clutch disc.
- Brake pads and linings.
- Shock absorbers.
- Struts.
- Engine Belts.
- Engine coolant hoses, clamps and o-rings.
- Diesel exhaust fluid replenishment.

Interest Free Finance Options Available

Take advantage of our interest free installment payment plan. Just a 10% down payment will provide you with an affordable, no interest, no fee payment program allowing you all the security and benefits Ford ESP has to offer while paying over time. You are pre-approved with no credit checks, no hassles! To learn more, call our Ford ESP specialists at 800-367-3377.

Ford ESP
P.O. Box 321067
Detroit, MI 48232

EXTENDED SERVICE PLAN (CANADA ONLY)

You can get more protection for your vehicle by purchasing a Ford Extended Service Plan. Ford Extended Service Plan is the only service contract backed by Ford Motor Company of Canada, Limited. Depending on the plan you purchase, Ford Extended Service Plan provides benefits such as:

- Rental reimbursement.
- Coverage for certain maintenance and wear items.
- Protection against repair costs after your New Vehicle Limited Warranty Coverage expires.
- Roadside Assistance benefits.

There are several Ford Extended Service Plans available in various time, distance and deductible combinations. Each plan is tailored to fit your own driving needs, including reimbursement for towing and rental. When you purchase Ford Extended Service Plan, you receive added peace-of-mind protection throughout Canada, the United States and Mexico, provided by a network of participating authorized Ford Motor Company dealers.

Note: *Repairs performed outside of Canada, the United States and Mexico are not eligible for Ford Extended Service Plan coverage.*

This information is subject to change. For more information, visit your local Ford of Canada dealer or www.ford.ca to find the Ford Extended Service Plan that is right for you.

Scheduled Maintenance

GENERAL MAINTENANCE INFORMATION

Why Maintain Your Vehicle?

Carefully following the maintenance schedule helps protect against major repair expenses resulting from neglect or inadequate maintenance and may help to increase the value of your vehicle when you sell or trade it. Keep all receipts for completed maintenance with your vehicle.

We have established regular maintenance intervals for your vehicle based upon rigorous testing. It is important that you have your vehicle serviced at the proper times. These intervals serve two purposes; one is to maintain the reliability of your vehicle and the second is to keep your cost of owning your vehicle down.

It is your responsibility to have all scheduled maintenance performed and to make sure that the materials used meet the specifications identified in this owner's manual. See **Capacities and Specifications** (page 361).

Failure to perform scheduled maintenance invalidates warranty coverage on parts affected by the lack of maintenance.

Why Maintain Your Vehicle at Your Dealership?

Factory-Trained Technicians

Service technicians participate in extensive factory-sponsored certification training to help them become experts on the operation of your vehicle. Ask your dealership about the training and certification their technicians have received.

Genuine Ford and Motorcraft® Replacement Parts

Dealerships stock Ford, Motorcraft and Ford-authorized branded re-manufactured replacement parts. These parts meet or exceed our specifications. Parts installed at your dealership carry a nationwide 24-month or unlimited mile (kilometer) parts and labor limited warranty.

If you do not use Ford authorized parts they may not meet our specifications and depending on the part, it could affect emissions compliance.

Convenience

Many dealerships have extended evening and Saturday hours to make your service visit more convenient and they offer one stop shopping. They can perform any services that are required on your vehicle, from general maintenance to collision repairs.

Note: *Not all dealers have extended hours or body shops. Please contact your dealer for details.*

Protecting Your Investment

Maintenance is an investment that pays dividends in the form of improved reliability, durability and resale value. To maintain the proper performance of your vehicle and its emission control systems, make sure you have scheduled maintenance performed at the designated intervals.

Your vehicle is equipped with the Intelligent Oil-Life Monitor system, which displays a message in the information display at the proper oil change interval. This interval may be up to one year or 10000 miles (16000 kilometers).

Scheduled Maintenance

When the oil change message appears in the information display, it is time for an oil change. Make sure you perform the oil change within two weeks or 500 miles (800 kilometers) of the message appearing. Make sure you reset the Intelligent Oil-Life Monitor after each oil change. See **General Information** (page 103).

If your information display resets prematurely or becomes inoperative, you should perform the oil change interval at six months or 5000 miles (8000 kilometers) from your last oil change. Never exceed one year or 10000 miles (16000 kilometers) between oil change intervals.

Your vehicle is very sophisticated and built with multiple, complex, performance systems. Every manufacturer develops these systems using different specifications and performance features. That is why it is important to rely upon your dealership to properly diagnose and repair your vehicle.

Ford Motor Company has recommended maintenance intervals for various parts and component systems based upon engineering testing. Ford Motor Company relies upon this testing to determine the most appropriate mileage for replacement of oils and fluids to protect your vehicle at the lowest overall cost to you and recommends against maintenance schedules that deviate from the scheduled maintenance information.

We strongly recommend the use of only genuine Ford, Motorcraft or Ford-authorized re-manufactured replacement parts engineered for your vehicle.

Additives and Chemicals

This owner's manual and the Ford Workshop Manual list the recommended additives and chemicals for your vehicle. We do not recommend using chemicals or additives not approved by us as part of your vehicle's normal maintenance. Please consult your warranty information.

Oils, Fluids and Flushing

In many cases, fluid discoloration is a normal operating characteristic and, by itself, does not necessarily indicate a concern or that the fluid needs to be changed. However, a qualified expert, such as the factory-trained technicians at your dealership, should inspect discolored fluids that also show signs of overheating or foreign material contamination immediately.

Make sure to change your vehicle's oils and fluids at the specified intervals or in conjunction with a repair. Flushing is a viable way to change fluid for many vehicle sub-systems during scheduled maintenance. It is critical that systems are flushed only with new fluid that is the same as that required to fill and operate the system or using a Ford-approved flushing chemical.

Owner Checks and Services

Make sure you perform the following basic maintenance checks and inspections every month or at six-month intervals.

Scheduled Maintenance

Check every month
Engine oil level.
Function of all interior and exterior lights.
Tires (including spare) for wear and proper pressure.
Windshield washer fluid level.

Check every six months
Battery connections. Clean if necessary.
Body and door drain holes for obstructions. Clean if necessary.
Cooling system fluid level and coolant strength.
Door weatherstrips for wear. Lubricate if necessary.
Hinges, latches and outside locks for proper operation. Lubricate if necessary.
Parking brake for proper operation.
Safety belts and seat latches for wear and function.
Safety warning lamps (brake, ABS, airbag and safety belt) for operation.
Washer spray and wiper operation. Clean or replace blades as necessary.

Multi-Point Inspection

In order to keep your vehicle running right, it is important to have the systems on your vehicle checked regularly. This can help identify potential issues and prevent major problems. We recommend having the following multi-point inspection performed at every scheduled maintenance interval to help make sure your vehicle keeps running great.

Scheduled Maintenance

Multi-Point inspection	
Accessory drive belt(s)	Hazard warning system operation
Battery performance	Horn operation
Engine air filter	Radiator, cooler, heater and air conditioning hoses
Exhaust system	Suspension components for leaks or damage
Exterior lamps operation	Steering and linkage
Fluid levels [*] ; fill if necessary	Tires (including spare) for wear and proper pressure ^{**}
For oil and fluid leaks	Windshield for cracks, chips or pits
Half-shaft dust boots	Washer spray and wiper operation

^{*} Brake, coolant recovery reservoir, automatic transmission and window washer

^{**} If your vehicle is equipped with a temporary mobility kit, check the tire sealant expiration Use By date on the canister. Replace as needed.

Be sure to ask your dealership service advisor or technician about the multi-point vehicle inspection. It is a comprehensive way to perform a thorough inspection of your vehicle. Your checklist gives you immediate feedback on the overall condition of your vehicle.

NORMAL SCHEDULED MAINTENANCE

Intelligent Oil-Life Monitor

Your vehicle is equipped with an Intelligent Oil-Life Monitor that determines when you should change the engine oil based on how your vehicle is used. By using several important factors in its calculations, the monitor helps reduce the cost of owning your vehicle and reduces environmental waste at the same time.

This means you do not have to remember to change the oil on a mileage-based schedule. Your vehicle lets you know when an oil change is due by displaying a message in the information display.

The following table provides examples of vehicle use and its impact on oil change intervals. It is a guideline only. Actual oil change intervals depend on several factors and generally decrease with severity of use.

Scheduled Maintenance

When to expect the message prompting you to change your oil	
Interval	Vehicle use and example
7500-10000 miles (12000-16000 km)	Normal
	Normal commuting with highway driving No, or moderate, load or towing Flat to moderately hilly roads No extended idling
5000-7499 miles (8000-11999 km)	Severe
	Moderate to heavy load or towing Mountainous or off-road conditions Extended idling Extended hot or cold operation
3000-4999 miles (4800-7999 km)	Extreme
	Maximum load or towing Extreme hot or cold operation

Normal Maintenance Intervals

At every oil change interval as indicated by the information display*
Change engine oil and filter.**
Rotate tires, inspect tire wear and measure tread depth.
Perform a multi-point inspection (recommended).
Inspect the automatic transmission fluid level (if equipped with dipstick). Consult your dealer for requirements.
Inspect the brake pads, shoes, rotors, drums, brake linings, hoses and parking brake.
Inspect the engine cooling system strength and hoses.
Inspect the exhaust system and heat shields.
Inspect front axle and U-joints. Lubricate if equipped with grease fittings (Four-wheel drive vehicles).
Inspect the half-shaft boots.

Scheduled Maintenance

At every oil change interval as indicated by the information display*
Inspect the steering linkage, ball joints, suspension, tire-rod ends, driveshaft and U-joints. Lubricate any areas with grease fittings.
Inspect the wheels and related components for abnormal noise, wear, looseness or drag.

* Do not exceed one year or 10000 miles (16000 kilometers) between service intervals.

** Reset the Intelligent Oil-Life Monitor after engine oil and filter changes.

Other maintenance items¹	
Every 30000 miles (48000 km)	Replace engine air filter.
At 100000 miles (160000 km)	Change engine coolant. ²
Every 100000 miles (160000 km)	Replace spark plugs.
	Inspect accessory drive belt(s). ³
Every 150000 miles (240000 km)	Change automatic transmission fluid and filter.
	Change front axle fluid (Four-wheel drive vehicles).
	Change rear axle fluid.
	Change transfer case fluid (Four-wheel drive vehicles).
	Replace accessory drive belt(s).

¹ Perform these maintenance items within 3000 miles (4800 kilometers) of the last engine oil and filter change. Do not exceed the designated distance for the interval.

² Initial replacement at six years or 100000 miles (160000 kilometers), then every three years or 50000 miles (80000 kilometers).

³ After initial inspection, inspect every other oil change until replaced.

Scheduled Maintenance

SPECIAL OPERATING CONDITIONS SCHEDULED MAINTENANCE

If you operate your vehicle **primarily** in any of the following conditions, you need to perform extra maintenance, as indicated. If you operate your vehicle **occasionally** under any of these conditions, it is not necessary to perform the extra maintenance. For specific recommendations, see your dealership service advisor or technician.

Perform the services shown in the following tables when specified or within 3,000 mi (4,800 km) of the **OIL CHANGE REQUIRED** message appearing in the information display.

- **Example 1:** The **OIL CHANGE REQUIRED** message comes on at 28,751 mi (46,270 km). Perform the 30,000 mi (48,000 km) automatic transmission fluid replacement.
- **Example 2:** The **OIL CHANGE REQUIRED** message has **not** come on, but the odometer reads 30,000 mi (48,000 km) (for example, the Intelligent Oil-Life Monitor was reset at 25,000 mi (40,000 km)). Perform the engine air filter replacement.

Towing a trailer or using a car-top carrier	
As required	Change engine oil and filter as indicated by the information display and perform services listed in the Normal Scheduled Maintenance chart.
Inspect frequently, service as required	Inspect and lubricate U-joints.
	See axle maintenance items under Exceptions .
Every 60,000 mi (96,000 km)	Change transfer case fluid (Four-wheel drive vehicles).
	Replace spark plugs.

Extensive idling or low-speed driving for long distances, as in heavy commercial use (such as delivery, taxi, patrol car or livery)	
As required	Change engine oil and filter as indicated by the information display and perform services listed in the Normal Scheduled Maintenance chart.
Inspect frequently, service as required	Replace engine air filter.
Every 60,000 mi (96,000 km)	Change transfer case fluid (Four-wheel drive vehicles).
	Replace spark plugs.

Scheduled Maintenance

Operating in dusty or sandy conditions (such as unpaved or dusty roads)	
Inspect frequently, service as required	Replace engine air filter.
Every 5,000 mi (8,000 km)	Inspect the wheels and related components for abnormal noise, wear, looseness or drag.
	Rotate tires, inspect tires for wear and measure tread depth.
Every 5,000 mi (8,000 km) or six months	Change engine oil and filter.*
Every 60,000 mi (96,000 km)	Change transfer case fluid (Four-wheel drive vehicles).

*Reset your Intelligent Oil-Life Monitor after each engine oil and filter change.

Off-road operation	
Inspect frequently, service as required	Inspect steering linkage, ball joints and U-joints. Lubricate if equipped with grease fittings.
	Replace engine air filter.
Every 5,000 mi (8,000 km) or six months	Change engine oil and filter.*
	Inspect the wheels and related components for abnormal noise, wear, looseness or drag.
	Rotate tires, inspect tires for wear and measure tread depth.
Every 30,000 mi (48,000 km)	Replace front wheel bearing grease and grease seals if non-sealed bearings are used (Two-wheel drive vehicles).
Every 60,000 mi (96,000 km)	Change transfer case fluid (Four-wheel drive vehicles).

*Reset your Intelligent Oil-Life Monitor after each engine oil and filter change.

Exclusive use of E85 (Flex fuel vehicles only)	
Every oil change interval	If ran exclusively on E85, fill the fuel tank full with regular unleaded fuel.

Scheduled Maintenance

Exceptions

There are several exceptions to the Normal Schedule.

Axle and Transfer Case Maintenance

Axle(s) and transfer case (4X4 only) fluid changes or level checks are not required unless a leak is suspected or the assembly has been submerged in water. During long periods of trailer towing with outside temperatures above 70°F (21°C) or at wide-open throttle for long periods above 45 mph (72 km/h), change the rear axle fluid every 3,000 mi (4,800 km) or three months, whichever comes first, if the rear axle is filled with non-synthetic fluid. This interval can be waived and the 150,000 mi (240,000km) service interval can continue if the rear axle is filled with 75W85 synthetic gear fluid meeting Ford specification WSS-M2C9Y2-A, part number XY-75W85-QL, or equivalent. Add friction modifier XL-3 (EST-M2C118-A) or equivalent for complete refill of Traction-Lok rear axles.

California Fuel Filter Replacement

If you register your vehicle in California, the California Air Resources Board has determined that the failure to perform this maintenance item does not nullify the emission warranty or limit recall liability before the completion of your vehicle's useful life. Ford Motor Company, however, urges you to have all recommended maintenance services performed at the specified intervals and to record all vehicle service.

Hot Climate Oil Change Intervals

Vehicles operating in the Middle East, North Africa, Sub-Saharan Africa or locations with similar climates using an American Petroleum Institute (API) Certified for Gasoline Engines (Certification mark) oil of SM or SN quality, the normal oil change interval is 3,000 mi (4,800 km).

If the available API SM or SN oils are not available, then the oil change interval is 1,800 mi (2,900 km).

Engine Air Filter Replacement

The life of the engine air filter is dependent on exposure to dusty and dirty conditions. Vehicles operated in these conditions require frequent inspection and replacement of the engine air filter.

Scheduled Maintenance

SCHEDULED MAINTENANCE RECORD

<input type="radio"/> Repair Order #:	<p>Dealer stamp</p>
<input type="radio"/> Distance:	
<input type="radio"/> Engine hours (optional):	
<input type="radio"/> Multi-point inspection (recommended): <input type="checkbox"/>	
<input type="radio"/> Signature:	

<input type="radio"/> Repair Order #:	<p>Dealer stamp</p>
<input type="radio"/> Distance:	
<input type="radio"/> Engine hours (optional):	
<input type="radio"/> Multi-point inspection (recommended): <input type="checkbox"/>	
<input type="radio"/> Signature:	

Scheduled Maintenance

<input type="radio"/> Repair Order #:	<p>Dealer stamp</p>
<input type="radio"/> Distance:	
<input type="radio"/> Engine hours (optional):	
<input type="radio"/> Multi-point inspection (recommended): <input type="checkbox"/>	
<input type="radio"/> Signature:	

<input type="radio"/> Repair Order #:	<p>Dealer stamp</p>
<input type="radio"/> Distance:	
<input type="radio"/> Engine hours (optional):	
<input type="radio"/> Multi-point inspection (recommended): <input type="checkbox"/>	
<input type="radio"/> Signature:	

Scheduled Maintenance

<input type="radio"/> Repair Order #:	Dealer stamp
<input type="radio"/> Distance:	
<input type="radio"/> Engine hours (optional):	
<input type="radio"/> Multi-point inspection (recommended): <input type="checkbox"/>	
<input type="radio"/> Signature:	

<input type="radio"/> Repair Order #:	Dealer stamp
<input type="radio"/> Distance:	
<input type="radio"/> Engine hours (optional):	
<input type="radio"/> Multi-point inspection (recommended): <input type="checkbox"/>	
<input type="radio"/> Signature:	

Scheduled Maintenance

<input type="radio"/> Repair Order #:	Dealer stamp
<input type="radio"/> Distance:	
<input type="radio"/> Engine hours (optional):	
<input type="radio"/> Multi-point inspection (recommended): <input type="checkbox"/>	
<input type="radio"/> Signature:	

<input type="radio"/> Repair Order #:	Dealer stamp
<input type="radio"/> Distance:	
<input type="radio"/> Engine hours (optional):	
<input type="radio"/> Multi-point inspection (recommended): <input type="checkbox"/>	
<input type="radio"/> Signature:	

Scheduled Maintenance

<input type="radio"/> Repair Order #:	Dealer stamp
<input type="radio"/> Distance:	
<input type="radio"/> Engine hours (optional):	
<input type="radio"/> Multi-point inspection (recommended): <input type="checkbox"/>	
<input type="radio"/> Signature:	

<input type="radio"/> Repair Order #:	Dealer stamp
<input type="radio"/> Distance:	
<input type="radio"/> Engine hours (optional):	
<input type="radio"/> Multi-point inspection (recommended): <input type="checkbox"/>	
<input type="radio"/> Signature:	

Scheduled Maintenance

<input type="radio"/> Repair Order #:	Dealer stamp
<input type="radio"/> Distance:	
<input type="radio"/> Engine hours (optional):	
<input type="radio"/> Multi-point inspection (recommended): <input type="checkbox"/>	
<input type="radio"/> Signature:	

<input type="radio"/> Repair Order #:	Dealer stamp
<input type="radio"/> Distance:	
<input type="radio"/> Engine hours (optional):	
<input type="radio"/> Multi-point inspection (recommended): <input type="checkbox"/>	
<input type="radio"/> Signature:	

Scheduled Maintenance

<input type="radio"/> Repair Order #:	<p>Dealer stamp</p>
<input type="radio"/> Distance:	
<input type="radio"/> Engine hours (optional):	
<input type="radio"/> Multi-point inspection (recommended): <input type="checkbox"/>	
<input type="radio"/> Signature:	

<input type="radio"/> Repair Order #:	<p>Dealer stamp</p>
<input type="radio"/> Distance:	
<input type="radio"/> Engine hours (optional):	
<input type="radio"/> Multi-point inspection (recommended): <input type="checkbox"/>	
<input type="radio"/> Signature:	

Scheduled Maintenance

<input type="radio"/> Repair Order #:	<p>Dealer stamp</p>
<input type="radio"/> Distance:	
<input type="radio"/> Engine hours (optional):	
<input type="radio"/> Multi-point inspection (recommended): <input type="checkbox"/>	
<input type="radio"/> Signature:	

<input type="radio"/> Repair Order #:	<p>Dealer stamp</p>
<input type="radio"/> Distance:	
<input type="radio"/> Engine hours (optional):	
<input type="radio"/> Multi-point inspection (recommended): <input type="checkbox"/>	
<input type="radio"/> Signature:	

Scheduled Maintenance

<input type="radio"/> Repair Order #:	<p>Dealer stamp</p>
<input type="radio"/> Distance:	
<input type="radio"/> Engine hours (optional):	
<input type="radio"/> Multi-point inspection (recommended): <input type="checkbox"/>	
<input type="radio"/> Signature:	

<input type="radio"/> Repair Order #:	<p>Dealer stamp</p>
<input type="radio"/> Distance:	
<input type="radio"/> Engine hours (optional):	
<input type="radio"/> Multi-point inspection (recommended): <input type="checkbox"/>	
<input type="radio"/> Signature:	

Scheduled Maintenance

<input type="radio"/> Repair Order #:	<p>Dealer stamp</p>
<input type="radio"/> Distance:	
<input type="radio"/> Engine hours (optional):	
<input type="radio"/> Multi-point inspection (recommended): <input type="checkbox"/>	
<input type="radio"/> Signature:	

<input type="radio"/> Repair Order #:	<p>Dealer stamp</p>
<input type="radio"/> Distance:	
<input type="radio"/> Engine hours (optional):	
<input type="radio"/> Multi-point inspection (recommended): <input type="checkbox"/>	
<input type="radio"/> Signature:	

Appendices

END USER LICENSE AGREEMENT

SYNC End User License Agreement (EULA)

- You have acquired a device ("DEVICE") that includes software licensed by Ford Motor Company and its affiliates ("FORD MOTOR COMPANY") from an affiliate of Microsoft Corporation ("MS"). Those installed software products of MS origin, as well as associated media, printed materials, and "online" or electronic documentation ("MS SOFTWARE") are protected by international intellectual property laws and treaties. The MS SOFTWARE is licensed, not sold. All rights reserved.
- The MS SOFTWARE may interface with and/or communicate with, or may be later upgraded to interface with and/or communicate with additional software and/or systems provided by FORD MOTOR COMPANY. The additional software and systems of FORD MOTOR COMPANY origin, as well as associated media, printed materials, and "online" or electronic documentation ("FORD SOFTWARE") are protected by international intellectual property laws and treaties. The FORD SOFTWARE is licensed, not sold. All rights reserved.

- The MS SOFTWARE and/or FORD SOFTWARE may interface with and/or communicate with, or may be later upgraded to interface with and/or communicate with additional software and/or systems provided by third party software and service suppliers. The additional software and services of third party origin, as well as associated media, printed materials, and "online" or electronic documentation ("THIRD PARTY SOFTWARE") are protected by international intellectual property laws and treaties. The THIRD PARTY SOFTWARE is licensed, not sold. All rights reserved.
- The MS SOFTWARE, FORD SOFTWARE and THIRD PARTY SOFTWARE hereinafter collectively and individually will be referred to as "SOFTWARE".

IF YOU DO NOT AGREE TO THIS END USER LICENSE AGREEMENT ("EULA") DO NOT USE THE DEVICE OR COPY THE SOFTWARE. ANY USE OF THE SOFTWARE, INCLUDING BUT NOT LIMITED TO USE ON THE DEVICE, WILL CONSTITUTE YOUR AGREEMENT TO THIS EULA (OR RATIFICATION OF ANY PREVIOUS CONSENT).

GRANT OF SOFTWARE LICENSE: This EULA grants you the following license:

- You may use the SOFTWARE as installed on the DEVICE and as otherwise interfacing with systems and/or services provide by or through FORD MOTOR COMPANY or its third party software and service providers.

Appendices

Description of Other Rights and Limitations

- **Speech Recognition:** If the SOFTWARE includes speech recognition component(s), you should understand that speech recognition is an inherently statistical process and that recognition errors are inherent in the process. Neither FORD MOTOR COMPANY nor its suppliers shall be liable for any damages arising out of errors in the speech recognition process.
- **Limitations on Reverse Engineering, Decompilation and Disassembly:** You may not reverse engineer, decompile, or disassemble nor permit others to reverse engineer, decompile or disassemble the SOFTWARE, except and only to the extent that such activity is expressly permitted by applicable law notwithstanding this limitation.
- **Limitations on Distributing, Copying, Modifying and Creating Derivative Works:** You may not distribute, copy, make modifications to or create derivative works based on the SOFTWARE, except and only to the extent that such activity is expressly permitted by applicable law notwithstanding this limitation.
- **Single EULA:** The end user documentation for the DEVICE and related systems and services may contain multiple EULAs, such as multiple translations and/or multiple media versions (e.g., in the user documentation and in the software). Even if you receive multiple EULAs, you are licensed to use only one (1) copy of the SOFTWARE.
- **SOFTWARE Transfer:** You may permanently transfer your rights under this EULA only as part of a sale or transfer of the DEVICE, provided you retain no copies, you transfer all of the SOFTWARE (including all component parts, the media and printed materials, any upgrades, and, if applicable, the Certificate(s) of Authenticity), and the recipient agrees to the terms of this EULA. If the SOFTWARE is an upgrade, any transfer must include all prior versions of the SOFTWARE.
- **Termination:** Without prejudice to any other rights, FORD MOTOR COMPANY or MS may terminate this EULA if you fail to comply with the terms and conditions of this EULA.
- **Security Updates/Digital Rights Management:** Content owners use the WMDRM technology included in your DEVICE to protect their intellectual property, included copyrighted content. Portions of the SOFTWARE on your DEVICE use WMDRM software to access WMDRM-protected content. If the WMDRM software fails to protect the content, content owners may ask Microsoft to revoke the SOFTWARE's ability to use WMDRM to play or copy protected content. This action does not affect unprotected content. When your DEVICE downloads licenses for protected content, you agree that Microsoft may include a revocation list with the licenses. Content owners may require you to upgrade the SOFTWARE on your DEVICE to access their content. If you decline an upgrade, you will not be able to access content that requires the upgrade.

Appendices

- **Consent to Use of Data:** You agree that MS, Microsoft Corporation, FORD MOTOR COMPANY, third party software and systems suppliers, their affiliates and/or their designated agent may collect and use technical information gathered in any manner as part of product support services related to the SOFTWARE or related services. MS, Microsoft Corporation, FORD MOTOR COMPANY, third party software and services suppliers, their affiliates and/or their designated agent may use this information solely to improve their products or to provide customized services or technologies to you. MS, Microsoft Corporation, FORD MOTOR COMPANY, third party software and systems suppliers, their affiliates and/or their designated agent may disclose this information to others, but not in a form that personally identifies you.
- **Internet-Based Services Components:** The SOFTWARE may contain components that enable and facilitate the use of certain Internet-based services. You acknowledge and agree that MS, Microsoft Corporation, FORD MOTOR COMPANY, third party software and service suppliers, their affiliates and/or their designated agent may automatically check the version of the SOFTWARE and/or its components that you are utilizing and may provide upgrades or supplements to the SOFTWARE that may be automatically downloaded to your DEVICE.
- **Additional Software/Services:** The SOFTWARE may permit FORD MOTOR COMPANY, third party software and service suppliers, MS, Microsoft Corporation, their affiliates and/or their designated agent to provide or make available to you SOFTWARE updates,

supplements, add-on components, or Internet-based services components of the SOFTWARE after the date you obtain your initial copy of the SOFTWARE ("Supplemental Components").

If FORD MOTOR COMPANY or third party software and services suppliers provide or make available to you Supplemental Components and no other EULA terms are provided along with the Supplemental Components, then the terms of this EULA shall apply.

If MS, Microsoft Corporation, their affiliates and/or their designated agent make available Supplemental Components, and no other EULA terms are provided, then the terms of this EULA shall apply, except that the MS, Microsoft Corporation or affiliate entity providing the Supplemental Component(s) shall be the licensor of the Supplemental Component(s).

FORD MOTOR COMPANY, MS, Microsoft Corporation, their affiliates and/or their designated agent reserve the right to discontinue without liability any Internet-based services provided to you or made available to you through the use of the SOFTWARE.

Appendices

- **Links to Third Party Sites:** The MS SOFTWARE may provide you with the ability to link to third party sites through the use of the SOFTWARE. The third party sites are not under the control of MS, Microsoft Corporation, their affiliates and/or their designated agent. Neither MS nor Microsoft Corporation nor their affiliates nor their designated agent are responsible for (i) the contents of any third party sites, any links contained in third party sites, or any changes or updates to third party sites, or (ii) webcasting or any other form of transmission received from any third party sites. If the SOFTWARE provides links to third party sites, those links are provided to you only as a convenience, and the inclusion of any link does not imply an endorsement of the third party site by MS, Microsoft Corporation, their affiliates and/or their designated agent.
- **Obligation to Drive Responsibly:** You recognize your obligation to drive responsibly and keep attention on the road. You will read and abide with the DEVICE operating instructions particularly as they pertain to safety and assumes any risk associated with the use of the DEVICE.

UPGRADES AND RECOVERY MEDIA:

If the SOFTWARE is provided by FORD MOTOR COMPANY separate from the DEVICE on media such as a ROM chip, CD ROM disk(s) or via web download or other means, and is labeled "For Upgrade Purposes Only" or "For Recovery Purposes Only" you may install one (1) copy of such SOFTWARE onto the DEVICE as a replacement copy for the existing SOFTWARE, and use it in accordance with this EULA, including any additional EULA terms accompanying the upgrade SOFTWARE.

INTELLECTUAL PROPERTY RIGHTS:

All title and intellectual property rights in and to the SOFTWARE (including but not limited to any images, photographs, animations, video, audio, music, text and "applets" incorporated into the SOFTWARE), the accompanying printed materials, and any copies of the SOFTWARE, are owned by MS, Microsoft Corporation, FORD MOTOR COMPANY, or their affiliates or suppliers. The SOFTWARE is licensed, not sold. You may not copy the printed materials accompanying the SOFTWARE. All title and intellectual property rights in and to the content which may be accessed through use of the SOFTWARE is the property of the respective content owner and may be protected by applicable copyright or other intellectual property laws and treaties. This EULA grants you no rights to use such content. All rights not specifically granted under this EULA are reserved by MS, Microsoft Corporation, FORD MOTOR COMPANY, third party software and service providers, their affiliates and suppliers. Use of any on-line services which may be accessed through the SOFTWARE may be governed by the respective terms of use relating to such services. If this SOFTWARE contains documentation that is provided only in electronic form, you may print one copy of such electronic documentation.

EXPORT RESTRICTIONS: You acknowledge that the SOFTWARE is subject to U.S. and European Union export jurisdiction. You agree to comply with all applicable international and national laws that apply to the SOFTWARE, including the U.S. Export Administration Regulations, as well as end-user, end-use and destination restrictions issued by U.S. and other governments. For additional information, see <http://www.microsoft.com/exporting/>.

Appendices

TRADEMARKS: This EULA does not grant you any rights in connection with any trademarks or service marks of FORD MOTOR COMPANY, MS, Microsoft Corporation, third party software or service providers, their affiliates or suppliers.

PRODUCT SUPPORT: Product support for the SOFTWARE is not provided by MS, its parent corporation Microsoft Corporation, or their affiliates or subsidiaries. For product support, please refer to FORD MOTOR COMPANY instructions provided in the documentation for the DEVICE. Should you have any questions concerning this EULA, or if you desire to contact FORD MOTOR COMPANY for any other reason, please refer to the address provided in the documentation for the DEVICE.

No Liability for Certain Damages: EXCEPT AS PROHIBITED BY LAW, FORD MOTOR COMPANY, ANY THIRD PARTY SOFTWARE OR SERVICES SUPPLIERS, MS, MICROSOFT CORPORATION AND THEIR AFFILIATES SHALL HAVE NO LIABILITY FOR ANY INDIRECT, SPECIAL, CONSEQUENTIAL OR INCIDENTAL DAMAGES ARISING FROM OR IN CONNECTION WITH THE USE OR PERFORMANCE OF THE SOFTWARE. THIS LIMITATION SHALL APPLY EVEN IF ANY REMEDY FAILS OF ITS ESSENTIAL PURPOSE. IN NO EVENT SHALL MS, MICROSOFT CORPORATION AND/OR THEIR AFFILIATES BE LIABLE FOR ANY AMOUNT IN EXCESS OF U.S. TWO HUNDRED FIFTY DOLLARS (U.S. \$250.00).

- THERE ARE NO WARRANTIES OTHER THAN THOSE THAT MAY EXPRESSLY BE PROVIDED FOR YOUR NEW VEHICLE.

Adobe

Contains Adobe® [Flash® Player] or [AIR®] technology by Adobe Systems Incorporated. This [Licensee Product] contains [Adobe® Flash® Player] [Adobe® AIR®] software under license from Adobe Systems Incorporated, Copyright ©1995-2009 Adobe Macromedia Software LLC. All rights reserved. Adobe, Flash and AIR are trademarks of Adobe Systems Incorporated.

End User Notice

Microsoft® Windows® Mobile for Automotive Important Safety Information

This system Ford SYNC contains software that is licensed to Manufacturer FORD MOTOR COMPANY by an affiliate of Microsoft Corporation pursuant to a license agreement. Any removal, reproduction, reverse engineering or other unauthorized use of the software from this system in violation of the license agreement is strictly prohibited and may subject you to legal action.

Read and follow instructions: Before using your Windows Automotive- based system, read and follow all instructions and safety information provided in this end user manual ("User's Guide"). Not following precautions found in this User's Guide can lead to an accident or other serious consequences.

Keep User's Guide in vehicle: When kept in the vehicle, the User's Guide will be a ready reference for you and other users unfamiliar with the Windows Automotive-based system. Please make certain that before using the system for the first time, all persons have access to the User's Guide and read its instructions and safety information carefully.

Appendices

WARNING



Operating certain parts of this system while driving can distract your attention away from the road, and possibly cause an accident or other serious consequences. Do not change system settings or enter data non-verbally (using your hands) while driving. Stop the vehicle in a safe and legal manner before attempting these operations. This is important since while setting up or changing some functions you might be required to distract your attention away from the road and remove your hands from the wheel.

General Operation

Voice Command Control: Functions within the Windows Automotive-based system may be accomplished using only voice commands. Using voice commands while driving allows you to operate the system without removing your hands from the wheel.

Prolonged Views of Screen: Do not access any function requiring a prolonged view of the screen while you are driving. Pull over in a safe and legal manner before attempting to access a function of the system requiring prolonged attention. Even occasional short scans to the screen may be hazardous if your attention has been diverted away from your driving task at a critical time.

Volume Setting: Do not raise the volume excessively. Keep the volume at a level where you can still hear outside traffic and emergency signals while driving. Driving while unable to hear these sounds could cause an accident.

Use of Speech Recognition Functions:

Speech recognition software is inherently a statistical process which is subject to errors. It is your responsibility to monitor any speech recognition functions included in the system and address any errors.

Navigation Features: Any navigation features included in the system are intended to provide turn by turn instructions to get you to a desired destination. Please make certain all persons using this system carefully read and follow instructions and safety information fully.

Distraction Hazard: Any navigation features may require manual (non-verbal) setup. Attempting to perform such set-up or insert data while driving can seriously distract your attention and could cause an accident or other serious consequences. Stop the vehicle in a safe and legal manner before attempting these operations.

Let Your Judgment Prevail: Any navigation features are provided only as an aid. Make your driving decisions based on your observations of local conditions and existing traffic regulations. Any such feature is not a substitute for your personal judgment. Any route suggestions made by this system should never replace any local traffic regulations or your personal judgment or knowledge of safe driving practices.

Route Safety: Do not follow the route suggestions if doing so would result in an unsafe or illegal maneuver, if you would be placed in an unsafe situation, or if you would be directed into an area that you consider unsafe. The driver is ultimately responsible for the safe operation of the vehicle and therefore, must evaluate whether it is safe to follow the suggested directions.

Appendices

Potential Map Inaccuracy: Maps used by this system may be inaccurate because of changes in roads, traffic controls or driving conditions. Always use good judgment and common sense when following the suggested routes.

Emergency Services: Do not rely on any navigation features included in the system to route you to emergency services. Ask local authorities or an emergency services operator for these locations. Not all emergency services such as police, fire stations, hospitals and clinics are likely to be contained in the map database for such navigation features.

Telenav Software End User License Agreement

Please read these terms and conditions carefully before you use the Telenav Software. Your use of the Telenav Software indicates that you accept these terms and conditions. If you do not accept these terms and conditions, do not break the seal of the package, launch, or otherwise use the Telenav Software.

These terms and conditions represent the agreement (“Agreement”) between you and Telenav, Inc. (“Telenav”) with respect to the Telenav Software (including upgrades, modifications, or additions thereto) (collectively “Telenav Software”). All references herein to “you” and “your” means you, your employees, agents, and contractors, and any other entity on whose behalf you accept these terms and conditions, all of whom shall also be bound by this Agreement. Additionally, all of your account information, as well as other payment and personal information provided by you to Telenav (directly or through the use of the Telenav Software, is subject to Telenav’s privacy policy located at <http://www.telenav.com>.

Telenav may revise this Agreement and the privacy policy at any time, with or without notice to you. You agree to visit <http://www.telenav.com> from time to time to review the then current version of this Agreement and of the privacy policy.

1. Safe and Lawful Use

You acknowledge that devoting attention to the Telenav Software may pose a risk of injury or death to you and others in situations that otherwise require your undivided attention, and you therefore agree to comply with the following when using the Telenav Software: (a) observe all traffic laws and otherwise drive safely; (b) use your own personal judgment while driving. If you feel that a route suggested by the Telenav Software instructs you to perform an unsafe or illegal maneuver, places you in an unsafe situation, or directs you into an area that you consider to be unsafe, do not follow such instructions; (c) do not input destinations, or otherwise manipulate the Telenav Software, unless your vehicle is stationary and parked; (d) do not use the Telenav Software for any illegal, unauthorized, unintended, unsafe, hazardous, or unlawful purposes, or in any manner inconsistent with this Agreement; (e) arrange all GPS and wireless devices and cables necessary for use of the Telenav Software in a secure manner in your vehicle so that they will not interfere with your driving and will not prevent the operation of any safety device (such as an airbag).

You agree to indemnify and hold Telenav harmless against all claims resulting from any dangerous or otherwise inappropriate use of the Telenav Software in any moving vehicle, including as a result of your failure to comply with the directions above.

Appendices

2. Account Information

You agree: (a) when registering the Telenav Software, to provide Telenav with true, accurate, current, and complete information about yourself, and (b) to inform Telenav promptly of any changes to such information, and to keep it true, accurate, current and complete.

3. Software License

Subject to your compliance with the terms of this Agreement, Telenav hereby grants to you a personal, non-exclusive, non-transferable license (except as expressly permitted below in connection with your permanent transfer of the Telenav Software license), without the right to sublicense, to use the Telenav Software (in object code form only) in order to access and use the Telenav Software. This license shall terminate upon any termination or expiration of this Agreement. You agree that you will use the Telenav Software only for your personal business or leisure purposes, and not to provide commercial navigation services to other parties.

3.1 License Limitations

You agree not to do any of the following: (a) reverse engineer, decompile, disassemble, translate, modify, alter or otherwise change the Telenav Software or any part thereof; (b) attempt to derive the source code, audio library or structure of the Telenav Software without the prior express written consent of Telenav; (c) remove from the Telenav Software, or alter, any of Telenav's or its suppliers' trademarks, trade names, logos, patent or copyright notices, or other notices or markings; (d) distribute, sublicense or otherwise transfer the Telenav Software to others, except as part of your permanent transfer of the Telenav Software; or (e) use the Telenav Software in any manner that (i) infringes the intellectual property

or proprietary rights, rights of publicity or privacy or other rights of any party, (ii) violates any law, statute, ordinance or regulation, including but not limited to laws and regulations related to spamming, privacy, consumer and child protection, obscenity or defamation, or (iii) is harmful, threatening, abusive, harassing, tortuous, defamatory, vulgar, obscene, libelous, or otherwise objectionable; and (f) lease, rent out, or otherwise permit unauthorized access by third parties to the Telenav Software without advanced written permission of Telenav.

4. Disclaimers

To the fullest extent permissible pursuant to applicable law, in no event will Telenav, its licensors and suppliers, or agents or employees of any of the foregoing, be liable for any decision made or action taken by you or anyone else in reliance on the information provided by the Telenav Software. Telenav also does not warrant the accuracy of the map or other data used for the Telenav Software. Such data may not always reflect reality due to, among other things, road closures, construction, weather, new roads and other changing conditions. You are responsible for the entire risk arising out of your use of the Telenav Software. For example but without limitation, you agree not to rely on the Telenav Software for critical navigation in areas where the well-being or survival of you or others is dependent on the accuracy of navigation, as the maps or functionality of the Telenav Software are not intended to support such high risk applications, especially in more remote geographical areas.

TELENAV EXPRESSLY DISCLAIMS AND EXCLUDES ALL WARRANTIES IN CONNECTION WITH THE TELENAV SOFTWARE, WHETHER STATUTORY, EXPRESS OR IMPLIED, INCLUDING ALL WARRANTIES WHICH MAY ARISE FROM

Appendices

COURSE OF DEALING, CUSTOM OR TRADE AND INCLUDING, BUT NOT LIMITED TO, THE IMPLIED WARRANTIES OF MERCHANTABILITY, FITNESS FOR A PARTICULAR PURPOSE AND NON-INFRINGEMENT OF THIRD PARTY RIGHTS WITH RESPECT TO THE TELENAV SOFTWARE. Certain jurisdictions do not permit the disclaimer of certain warranties, so this limitation may not apply to you.

5. Limitation of Liability

TO THE EXTENT PERMITTED UNDER APPLICABLE LAW, UNDER NO CIRCUMSTANCES SHALL TELENAV OR ITS LICENSORS AND SUPPLIERS BE LIABLE TO YOU OR TO ANY THIRD PARTY FOR ANY INDIRECT, INCIDENTAL, CONSEQUENTIAL, SPECIAL OR EXEMPLARY DAMAGES (INCLUDING IN EACH CASE, BUT NOT LIMITED TO, DAMAGES FOR THE INABILITY TO USE THE EQUIPMENT OR ACCESS DATA, LOSS OF DATA, LOSS OF BUSINESS, LOSS OF PROFITS, BUSINESS INTERRUPTION OR THE LIKE) ARISING OUT OF THE USE OF OR INABILITY TO USE THE TELENAV SOFTWARE, EVEN IF TELENAV HAS BEEN ADVISED OF THE POSSIBILITY OF SUCH DAMAGES.

NOTWITHSTANDING ANY DAMAGES THAT YOU MIGHT INCUR FOR ANY REASON WHATSOEVER (INCLUDING, WITHOUT LIMITATION, ALL DAMAGES REFERENCED HEREIN AND ALL DIRECT OR GENERAL DAMAGES IN CONTRACT, TORT (INCLUDING NEGLIGENCE) OR OTHERWISE), THE ENTIRE LIABILITY OF TELENAV AND OF ALL OF TELENAV'S SUPPLIERS SHALL BE LIMITED TO THE AMOUNT ACTUALLY PAID BY YOU FOR THE TELENAV SOFTWARE. SOME

STATES AND/OR JURISDICTIONS DO NOT ALLOW THE EXCLUSION OR LIMITATION OF INCIDENTAL OR CONSEQUENTIAL DAMAGES, SO THE ABOVE LIMITATIONS OR EXCLUSIONS MAY NOT APPLY TO YOU.

6. Arbitration and Governing Law

You agree that any dispute, claim or controversy arising out of or relating to this Agreement or the Telenav Software shall be settled by independent arbitration involving a neutral arbitrator and administered by the American Arbitration Association in the County of Santa Clara, California. The arbitrator shall apply the Commercial Arbitration Rules of the American Arbitration Association, and the judgment upon the award rendered by the arbitrator may be entered by any court having jurisdiction. Note that there is no judge or jury in an arbitration proceeding and the decision of the arbitrator shall be binding upon both parties. You expressly agree to waive your right to a jury trial.

This Agreement and performance hereunder will be governed by and construed in accordance with the laws of the State of California, without giving effect to its conflict of laws provisions. To the extent judicial action is necessary in connection with the binding arbitration, both Telenav and you agree to submit to the exclusive jurisdiction of the courts of the County of Santa Clara, California. The United Nations Convention on Contracts for the International Sale of Goods shall not apply.

7. Assignment

You may not resell, assign, or transfer this Agreement or any of your rights or obligations, except in totality, in connection with your permanent transfer of the Telenav Software, and expressly conditioned upon the new user of the Telenav Software agreeing to be bound by

Appendices

the terms and conditions of this Agreement. Any such sale, assignment or transfer that is not expressly permitted under this paragraph will result in immediate termination of this Agreement, without liability to Telenav, in which case you and all other parties shall immediately cease all use of the Telenav Software. Notwithstanding the foregoing, Telenav may assign this Agreement to any other party at any time without notice, provided the assignee remains bound by this Agreement.

8. Miscellaneous

8.1

This Agreement constitutes the entire agreement between Telenav and you with respect to the subject matter hereof.

8.2

Except for the limited licenses expressly granted in this Agreement, Telenav retains all right, title and interest in and to the Telenav Software, including without limitation all related intellectual property rights. No licenses or other rights which are not expressly granted in this Agreement are intended to, or shall be, granted or conferred by implication, statute, inducement, estoppel or otherwise, and Telenav and its suppliers and licensors hereby reserve all of their respective rights other than the licenses explicitly granted in this Agreement.

8.3

By using the Telenav Software, you consent to receive from Telenav all communications, including notices, agreements, legally required disclosures or other information in connection with the Telenav Software (collectively, "Notices") electronically. Telenav may provide such

Notices by posting them on Telenav's Website or by downloading such Notices to your wireless device. If you desire to withdraw your consent to receive Notices electronically, you must discontinue your use of the Telenav Software.

8.4

Telenav's or your failure to require performance of any provision shall not affect that party's right to require performance at any time thereafter, nor shall a waiver of any breach or default of this Agreement constitute a waiver of any subsequent breach or default or a waiver of the provision itself.

8.5

If any provision herein is held unenforceable, then such provision will be modified to reflect the intention of the parties, and the remaining provisions of this Agreement will remain in full force and effect.

8.6

The headings in this Agreement are for convenience of reference only, will not be deemed to be a part of this Agreement, and will not be referred to in connection with the construction or interpretation of this Agreement. As used in this Agreement, the words "include" and "including," and variations thereof, will not be deemed to be terms of limitation, but rather will be deemed to be followed by the words "without limitation".

9. Other Vendors Terms and Conditions

The Telenav Software utilizes map and other data licensed to Telenav by third party vendors for the benefit of you and other end users. This Agreement includes end-user terms applicable to these companies (included at the end of this

Appendices

Agreement), and thus your use of the Telenav Software is also subject to such terms. You agree to comply with the following additional terms and conditions, which are applicable to Telenav's third party vendor licensors:

End User License Agreement For Distribution By HERE For North America/APAC

The content provided ("Data") is licensed, not sold. By opening this package, or installing, copying, or otherwise using the Data, you agree to be bound by the terms of this agreement. If you do not agree to the terms of this agreement, you are not permitted to install, copy, use, resell or transfer the Data. If you wish to reject the terms of this agreement, and have not installed, copied, or used the Data, you must contact your retailer or HERE North America, LLC (as defined below) within thirty (30) days of purchase for a refund of your purchase price. To contact HERE, please visit www.here.com.

The Data is provided for your personal, internal use only and may not be resold. It is protected by copyright, and is subject to the following terms (this "End User License Agreement") and conditions which are agreed to by you, on the one hand, and HERE and its licensors (including their licensors and suppliers) on the other hand. For purposes of these terms, "HERE" shall mean (a) HERE North America, LLC with respect to Data for the Americas and/or the Asia Pacific region and (b) HERE Europe B.V. for Data for Europe, the Middle East and/or Africa.

The Data includes certain information and related content provided under license to HERE from third parties and is subject to the applicable supplier terms and copyright notices set forth at the following URL:
http://corporate.navteq.com/supplier_terms.html.

TERMS AND CONDITIONS

License Limitations on Use:

You agree that your license to use this Data is limited to and conditioned on use for solely personal, noncommercial purposes, and not for service bureau, timesharing or other similar purposes. Except as otherwise set forth herein, you agree not to otherwise reproduce, copy, modify, decompile, disassemble or reverse engineer any portion of this Data, and may not transfer or distribute it in any form, for any purpose, except to the extent permitted by mandatory laws.

License Limitations on Transfer:

Your limited license does not allow transfer or resale of the Data, except on the condition that you may transfer the Data and all accompanying materials on a permanent basis if: (a) you retain no copies of the Data; (b) the recipient agrees to the terms of this End-User License Agreement; and (c) you transfer the Data in the exact same form as you purchased it by physically transferring the original media (e.g., the CD-ROM or DVD you purchased), all original packaging, all Manuals and other documentation. Specifically, Multi-disc sets may only be transferred or sold as a complete set as provided to you and not as a subset thereof.

Additional License Limitations:

Except where you have been specifically licensed to do so by HERE in a separate written agreement, and without limiting the preceding paragraph, your license is conditioned on use of the Data as prescribed in this agreement, and you may not (a) use this Data with any products, systems, or applications installed or otherwise connected to or in communication with vehicles capable of vehicle navigation, positioning, dispatch,

Appendices

real time route guidance, fleet management or similar applications; or (b) with, or in communication with, including without limitation, cellular phones, palmtop and handheld computers, pagers, and personal digital -assistants or PDAs.

Note: *This Data may contain inaccurate or incomplete information due to the passage of time, changing circum-stances, sources used and the nature of collecting comprehensive geographic Data, any of which may lead to incorrect results.*

No Warranty:

This Data is provided to you "as is", and you agree to use it at your own risk. HERE and its licensors (and their licensors and suppliers) make no guarantees, representations or warranties of any kind, express or implied, arising by law or otherwise, including but not limited to, content, quality, accuracy, completeness, effectiveness, reliability, fitness for a particular purpose, usefulness, use or results to be obtained from this Data, or that the Data or server will be uninterrupted or error -free.

Disclaimer of Warranty:

HERE AND ITS LICENSORS (INCLUDING THEIR LICENSORS AND SUPPLIERS) DISCLAIM ANY WARRANTIES, EXPRESS OR IMPLIED, OF QUALITY, PERFORMANCE, MERCHANTABILITY, FITNESS FOR A PARTICULAR PURPOSE OR NON-INFRINGEMENT. Some States, Territories and Countries do not allow certain warranty exclusions, so to that extent the above exclusion may not apply to you.

Disclaimer of Liability:

HERE AND ITS LICENSORS (INCLUDING THEIR LICENSORS AND SUPPLIERS) SHALL NOT BE LIABLE TO YOU IN RESPECT OF ANY CLAIM, DEMAND OR ACTION, IRRESPECTIVE OF THE NATURE OF THE CAUSE OF THE CLAIM, DEMAND OR ACTION ALLEGING ANY LOSS, INJURY OR DAMAGES, DIRECT OR INDIRECT, WHICH MAY RESULT FROM THE USE OR POSSESSION OF THIS DATA; OR FOR ANY LOSS OF PROFIT, REVENUE, CONTRACTS OR SAVINGS, OR ANY OTHER DIRECT, INDIRECT, INCIDENTAL, SPECIAL OR CONSEQUENTIAL DAMAGES ARISING OUT OF YOUR USE OF OR INABILITY TO USE THIS DATA, OR THE BREACH OF THESE TERMS OR CONDITIONS, WHETHER IN AN ACTION IN CONTRACT OR TORT OR BASED ON A WARRANTY, EVEN IF HERE OR ITS LICENSORS HAVE BEEN ADVISED OF THE POSSIBILITY OF SUCH DAMAGES. Some States, Territories and Countries do not allow certain liability exclusions or damages limitations, so to that extent the above may not apply to you.

Export Control:

You agree not to export from anywhere any part of the Data or any direct product thereof except in compliance with, and with all licenses and approvals required under, applicable export laws, rules and regulations, including but not limited to the laws, rules and regulations administered by the Office of Foreign Assets Control of the U.S. Department of Commerce and the Bureau of Industry and Security of the U.S. Department of Commerce. To the extent that any such export laws, rules or regulations prohibit HERE from complying with any of its obligations hereunder to deliver or distribute Data, such failure shall be excused and shall not constitute a breach of this Agreement.

Appendices

Entire Agreement:

These terms and conditions constitute the entire agreement between HERE (and its licensors, including their licensors and suppliers) and you pertaining to the subject matter hereof, and supersedes in their entirety any and all written or oral agreements previously existing between us with respect to such subject matter.

Severability:

You and HERE agree that if any portion of this agreement is found illegal or unenforceable, that portion shall be severed and the remainder of the Agreement shall be given full force and effect.

Severability:

You and HERE agree that if any portion of this agreement is found illegal or unenforceable, that portion shall be severed and the remainder of the Agreement shall be given full force and effect.

Governing Law:

The above terms and conditions shall be governed by the laws of the State of Illinois (for Data for the Americas and/or the Asia Pacific region) or The Netherlands (for Data for Europe, the Middle East and Africa), without giving effect to (i) its conflict of laws provisions, or (ii) the United Nations Convention for Contracts for the International Sale of Goods, which is explicitly excluded. For any and all disputes, claims and actions arising from or in connection with the Data ("Claims"), you agree to submit to the personal jurisdiction of (a) the State of Illinois for Claims related to Data for the Americas and/or the Asia Pacific region provided to you hereunder, and (b) The Netherlands for Data for Europe, the Middle East and/or Africa provided to you hereunder.

Government End Users:

If the Data is being acquired by or on behalf of the United States government or any other entity seeking or applying rights similar to those customarily claimed by the United States government, this Data is a "commercial item" as that term is defined at 48 C.F.R. ("FAR") 2.101, is licensed in accordance with this End User License Agreement, and each copy of Data delivered or otherwise furnished shall be marked and embedded as appropriate with the following "Notice of Use", and be treated in accordance with such Notice:

NOTICE OF USE

CONTRACTOR
(MANUFACTURER/SUPPLIER)

NAME:

HERE

CONTRACTOR
(MANUFACTURER/SUPPLIER)

ADDRESS:

425 West Randolph Street, Chicago, IL 60606.

This Data is a commercial item as defined in FAR 2.101

and is subject to the End User License Agreement under

which this Data was provided.

© 1987-2013 HERE. All rights reserved.

If the Contracting Officer, federal government agency, or any federal official refuses to use the legend provided herein, the Contracting Officer, federal government agency, or any federal official must notify HERE prior to seeking additional or alternative rights in the Data.

Appendices

Gracenote® Copyright

CD and music-related data from Gracenote, Inc., copyright© 2000-2007 Gracenote. Gracenote Software, copyright © 2000-2007 Gracenote. This product and service may practice one or more of the following U.S. Patents #5,987,525, #6,061,680, #6,154,773, #6,161,132, #6,230,192, #6,230,207, #6,240,459, #6,330,593 and other patents issued or pending. Some services supplied under license from Open Globe, Inc. for U.S. Patent: #6,304,523.

Gracenote and CDDb are registered trademarks of Gracenote. The Gracenote logo and logotype, and the "Powered by Gracenote™" logo are trademarks of Gracenote.

Gracenote® End User License Agreement (EULA)

This device contains software from Gracenote, Inc. of 2000 Powell Street Emeryville, California 94608 ("Gracenote").

The software from Gracenote (the "Gracenote Software") enables this device to do disc and music file identification and obtain music-related information, including name, artist, track, and title information ("Gracenote Data") from online servers ("Gracenote Servers"), and to perform other functions. You may use Gracenote Data only by means of the intended End User functions of this device.

This device may contain content belonging to Gracenote's providers. If so, all of the restrictions set forth herein with respect to Gracenote Data shall also apply to such content and such content providers shall be entitled to all of the benefits and protections set forth herein that are available to Gracenote.

You agree that you will use the content from Gracenote ("Gracenote Content"), Gracenote Data, the Gracenote Software, and Gracenote Servers for your own personal, non-commercial use only. You agree not to assign, copy, transfer or transmit the Gracenote Content, Gracenote Software or any Gracenote Data (except in a Tag associated with a music file) to any third party. YOU AGREE NOT TO USE OR EXPLOIT GRACENOTE CONTENT, GRACENOTE DATA, THE GRACENOTE SOFTWARE, OR GRACENOTE SERVERS, EXCEPT AS EXPRESSLY PERMITTED HEREIN.

You agree that your non-exclusive licenses to use the Gracenote Content, Gracenote Data, the Gracenote Software, and Gracenote Servers will terminate if you violate these restrictions. If your licenses terminate, you agree to cease any and all use of the Gracenote Content, Gracenote Data, the Gracenote Software, and Gracenote Servers. Gracenote, respectively, reserve all rights in Gracenote Data, the Gracenote Software, and the Gracenote Servers and Gracenote Content, including all ownership rights. Under no circumstances will either Gracenote become liable for any payment to you for any information that you provide, including any copyrighted material or music file information. You agree that Gracenote may enforce its respective rights, collectively or separately, under this agreement against you, directly in each company's own name.

Gracenote uses a unique identifier to track queries for statistical purposes. The purpose of a randomly assigned numeric identifier is to allow Gracenote to count queries without knowing anything about who you are. For more information, see the web page at www.gracenote.com for the Gracenote Privacy Policy.

Appendices

THE GRACENOTE SOFTWARE, EACH ITEM OF GRACENOTE DATA AND THE GRACENOTE CONTENT ARE LICENSED TO YOU "AS IS". NEITHER GRACENOTE MAKES ANY REPRESENTATIONS OR WARRANTIES, EXPRESS OR IMPLIED, REGARDING THE ACCURACY OF ANY GRACENOTE DATA FROM THE GRACENOTE SERVERS OR GRACENOTE CONTENT. GRACENOTE COLLECTIVELY AND SEPARATELY RESERVE THE RIGHT TO DELETE DATA AND/OR CONTENT FROM THE COMPANIES' RESPECTIVE SERVERS OR, IN THE CASE OF GRACENOTE, CHANGE DATA CATEGORIES FOR ANY CAUSE THAT GRACENOTE DEEMS SUFFICIENT. NO WARRANTY IS MADE THAT EITHER GRACENOTE CONTENT OR THE GRACENOTE SOFTWARE OR GRACENOTE SERVERS ARE ERROR-FREE OR THAT THE FUNCTIONING OF THE GRACENOTE SOFTWARE OR GRACENOTE SERVERS WILL BE UNINTERRUPTED. GRACENOTE IS NOT OBLIGATED TO PROVIDE YOU WITH ANY ENHANCED OR ADDITIONAL DATA TYPES THAT GRACENOTE MAY CHOOSE TO PROVIDE IN THE FUTURE AND IS FREE TO DISCONTINUE ITS ONLINE SERVICES AT ANY TIME. GRACENOTE DISCLAIM ALL WARRANTIES EXPRESS OR IMPLIED, INCLUDING, BUT NOT LIMITED TO, IMPLIED WARRANTIES OF MERCHANTABILITY, FITNESS FOR A PARTICULAR PURPOSE, TITLE, AND NON-INFRINGEMENT. NEITHER GRACENOTE WARRANTS THE RESULTS THAT WILL BE OBTAINED BY YOUR USE OF THE GRACENOTE SOFTWARE OR ANY GRACENOTE SERVER. IN NO CASE WILL GRACENOTE BE LIABLE FOR ANY CONSEQUENTIAL OR INCIDENTAL DAMAGES OR FOR ANY LOST PROFITS OR LOST REVENUES FOR ANY REASON WHATSOEVER.

© Gracenote 2007.

Vehicle with SYNC only

FCC ID: KMHSG1P1

IC: 1422A-SG1P1

Vehicle with SYNC and MyFord Touch or MyLincoln Touch

FCC ID: KMHSYNG2

IC: 1422A-SYNG2

This device complies with Part 15 of the FCC Rules and with RSS-210 of Industry Canada. Operation is subject to the following two conditions: (1) This device may not cause harmful interference, and (2) this device must accept any interference received, including interference that may cause undesired operation.

WARNING



Changes or modifications not expressly approved by the party responsible for compliance could void the user's authority to operate the equipment. The term "IC" before the radio certification number only signifies that Industry Canada technical specifications were met.

The antenna used for this transmitter must not be co-located or operating in conjunction with any other antenna or transmitter.

Appendices

TYPE APPROVALS

RF Certification Logos for Tire Pressure Monitoring Sensor(s)

Schrader AG2SZ4 Numero de Registro
CNC: H-13498

E207816

Argentina

TRA
REGISTERED NO:EROI30238/14
DEALER NO:DA0047074/10

E207817

Abu Dhabi, Dubai



E197509



E202555

Brazil

Herby, Schrader Electronics UK Ltd., declares that this TPMS is in compliance with the essential requirements and other provisions of directive 1999/5/EC. The declaration of conformity may be consulted at emcteam@schrader.co.uk

E207818

European Union EU

Kingdom of Jordan Type approval for tyre pressure sensor.
Model: AG2SZ4
Manufacturer: Schrader Electronics
Type Approval Number: TRC/LPD/2014/56

E207819

Jordan

RAQP/33A/0514/S/(14-0847)

E207820

Malaysia

Appendices



1 0 2 4

E197811

Moldova

Complies with
IDA Standards
DA 00461

E207822

Singapore

AGREE PAR L'ANRT MAROC
Numéro d'agrément: MR9098
ANRT 2014
Date d'agrément: 14/03/2014



TA-2014/064

Approved

E207821

Morocco

E198002

South Africa



NTC

Type Approved

No:ESD-1408639C



CCAM14LP0460T0

E198001

Philippines

E203899

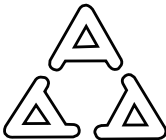

И 011 14

E197844

Serbia

Appendices



CCAM14LP0090T3

E203679

Taiwan



Schrader Electronics цім стверджує, що
обладнання Радіопередавач моделі AG2S24
системи контролю тиску в шині
автомобіла відповідає вимогам Технічного
регламенту радіобладнання і
телекомунікаційного кінцевого
(термінального) обладнання (Постанова РМВ
№ 679 від 24 червня 2009 р.) Декларація
відповідності знаходиться на сайті Schrader

Electronics та надається за запитом на електронну адресу doc.request@schrader.co.uk

E198009

Ukraine

Index

3

360 Degree Camera.....	209
Camera Views.....	210
Front Camera.....	210
Side Camera.....	211

4

4WD	
See: Four-Wheel Drive.....	180

A

A/C	
See: Climate Control.....	131
About This Manual.....	7
ABS	
See: Brakes.....	190
ABS driving hints	
See: Hints on Driving With Anti-Lock Brakes.....	190
Accessories.....	497
Exterior style.....	497
Interior style.....	497
Lifestyle.....	497
Peace of mind.....	497
Accessories	
See: Replacement Parts Recommendation.....	11
ACC	
See: Using Adaptive Cruise Control.....	213
Active Park Assist.....	202
Automatic Steering into Parking Space.....	204
Deactivating the Park Assist Feature.....	204
Troubleshooting the System.....	205
Using Active Park Assist.....	203
Adjusting the Headlamps.....	312
Horizontal Aim Adjustment.....	313
Vertical Aim Adjustment.....	312
Adjusting the Pedals.....	77
Adjusting the Steering Wheel.....	73
Power Tilt and Telescope Steering Column.....	73
Airbag Disposal.....	50
Air Conditioning	
See: Climate Control.....	131

Air Filter	
See: Changing the Engine Air Filter.....	320
Alarm	
See: Anti-Theft Alarm.....	69
Ambient Lighting.....	87
Anti-Theft Alarm.....	69
Arming the Alarm.....	70
Disarming the Alarm.....	70
Full Guard.....	70
Reduced Guard.....	69
Appendices.....	520
Audible Warnings and Indicators.....	102
Airbag Secondary Warning.....	102
Beltminder Warning.....	102
Door Ajar Warning.....	102
Headlamps On Warning.....	102
Key in Ignition Warning.....	102
Keyless Warning Alert.....	102
Parking Brake On Warning.....	102
Rear Park Aid Warning.....	102
Service Advancetrac Warning.....	102
Audio Control.....	74
Media.....	74
Seek, Next or Previous.....	74
Audio Input Jack.....	400
Audio System.....	383
General Information.....	383
Audio Unit - Vehicles With: AM/FM/CD/ SYNC/Satellite Radio.....	391
Audio Unit - Vehicles With: AM/FM/ CD.....	386
Audio Unit - Vehicles With: AM/FM/ SYNC.....	389
Audio Unit - Vehicles With: AM/ FM.....	384
Audio Unit - Vehicles With: Sony AM/ FM/CD.....	393
Autolamps.....	80
Windshield Wiper Activated Headlamps.....	81
Automatic Climate Control.....	133
Automatic High Beam Control.....	82
Activating the System.....	83
Manually Overriding the System.....	83

Index

Automatic Transmission.....174	Capacities and Specifications - 3.5L
Brake-Shift Interlock.....177	EcoBoost™.....369
If Your Vehicle Gets Stuck In Mud or Snow.....179	Specifications.....370
Understanding the Shift Positions of a 6-Speed Automatic Transmission.....174	Capacities and Specifications - 5.0L.....378
Understanding your SelectShift Automatic™ transmission.....176	Specifications.....379
Automatic Transmission Fluid	Capacities and Specifications.....361
Check.....308	Car Wash
Auto-Start-Stop.....164	See: Cleaning the Exterior.....321
Disabling Auto StartStop.....165	Center Console.....156
Enabling Auto StartStop.....164	Changing a Bulb.....313
Autowipers.....78	Accessing the Halogen High Beam, Low Beam and Direction Indicator
Auxiliary Power Points.....154	Bulbs.....314
110 Volt - 400 Watt Capacity AC Power Outlet.....154	Lamp Assembly Condensation.....314
12 Volt DC Power Point.....154	Replacing Brake, Rear, Direction Indicator and Reverse Lamp Bulbs.....316
Locations.....154	Replacing Cargo Lamp and High-mount Brake Lamp Bulbs.....317
B	Replacing Exterior Mounted Mirror Direction Indicator Lamp Bulbs.....318
Battery	Replacing Fog Lamp Bulbs.....316
See: Changing the 12V Battery.....309	Replacing LED Brake, Rear, Direction Indicator and Reverse Lamp Bulbs.....317
Blind Spot Information System.....224	Replacing LED Cargo Lamp, Spot Lamp and High-mount Brake Lamp Bulbs.....317
Switching the System Off and On.....226	Replacing LED Direction Indicator and Side Marker Bulbs.....316
System Errors.....226	Replacing LED Headlamp Bulbs.....316
Using the System.....224	Replacing Side Marker Bulb.....316
Bonnet Lock	Replacing the Halogen High Beam, Low Beam and Direction Indicator
See: Opening and Closing the Hood.....298	Bulbs.....315
Booster Seats.....28	Replacing the License Plate Lamp Bulb.....317
Types of Booster Seats.....28	Changing a Fuse.....297
Brake Fluid Check.....309	Fuses.....297
Brakes.....190	Changing a Road Wheel.....352
General Information.....190	Dissimilar Spare Wheel and Tire Assembly Information.....352
Breaking-In.....272	Location of the Spare Tire and Tools.....353
Bulb Specification Chart.....318	Tire Change Procedure.....354
C	Changing the 12V Battery.....309
Cabin Air Filter.....137	Battery Management System.....311
California Proposition 65.....11	Changing the Engine Air Filter.....320
Capacities and Specifications - 2.7L	Changing the Wiper Blades.....311
EcoBoost™.....365	Checking MyKey System Status.....59
Specifications.....366	Checking the Wiper Blades.....311
Capacities and Specifications - 3.5L.....373	
Specifications.....374	

Index

Child Restraint and Seatbelt	
Maintenance.....	41
Child Restraint Positioning.....	30
Child Safety.....	15
General Information.....	15
Child Safety Locks.....	31
Left-Hand Side.....	32
Right-Hand Side.....	32
Cleaning Leather Seats.....	325
With King Ranch Edition.....	325
Without King Ranch Edition.....	325
Cleaning Products.....	321
Cleaning the Alloy Wheels.....	326
Cleaning the Engine.....	323
Cleaning the Exterior.....	321
Exterior Chrome Parts.....	322
Exterior Plastic Parts.....	322
Stripes or Graphics.....	322
Underbody.....	322
Cleaning the Instrument Panel and	
Instrument Cluster Lens.....	324
Cleaning the Interior.....	324
Cleaning the Windows and Wiper	
Blades.....	323
Clearing All MyKeys.....	58
Climate.....	485
Climate Control Voice Commands.....	487
Climate Control.....	131
Climate Controlled Seats.....	147
Cooled Seats.....	148
Collision Warning System.....	230
Principle Of Operation.....	230
Coolant Check	
See: Engine Coolant Check.....	304
Crash Sensors and Airbag Indicator.....	49
Creating a MyKey.....	58
Programming/Changing Configurable	
Settings.....	58
Cross Traffic Alert.....	226
False Alerts.....	229
Switching the System Off and On.....	229
System Errors.....	229
System Lights, Messages and Audible	
Alerts.....	228
System Limitations.....	228
Using the System.....	226
Cruise Control.....	75
Principle of Operation.....	212
Type 1.....	75
Type 2.....	75
Cruise control	
See: Using Cruise Control.....	212
Customer Assistance.....	282
D	
Data Recording.....	9
Event Data Recording.....	9
Service Data Recording.....	9
Daytime Running Lamps.....	82
Type 1 - Conventional	
(Non-Configurable).....	82
Type 2 - Configurable.....	82
Digital Radio.....	395
HD Radio Reception and Station	
Troubleshooting.....	396
Direction Indicators.....	84
Lane Change.....	84
Driver Alert.....	220
Using Driver Alert.....	220
Driver and Passenger Airbags.....	44
Children and Airbags.....	44
Proper Driver and Front Passenger Seating	
Adjustment.....	44
Driving Aids.....	220
Driving Hints.....	272
Driving Through Water.....	273
DRL	
See: Daytime Running Lamps.....	82
E	
Economical Driving.....	272
Electric Parking Brake.....	191
Applying the Electric Parking Brake.....	191
Applying the Electric Parking Brake When	
the Vehicle is Moving.....	192
Battery With No Charge.....	193
Releasing the Electric Parking Brake.....	192
Electronic Locking Differential.....	188
Activating the Electronic Locking	
Differential.....	188

Index

Emission Control System.....	171
On-Board Diagnostics (OBD-II).....	172
Readiness for Inspection/Maintenance (I/M) Testing.....	173
End User License Agreement.....	520
SYNC End User License Agreement (EULA).....	520
Engine Block Heater.....	162
Using the Engine Block Heater.....	163
Engine Coolant Check.....	304
Adding Engine Coolant.....	305
Checking the Engine Coolant.....	304
Recycled Engine Coolant.....	305
Severe Climates.....	306
What You Should Know About Fail-Safe Cooling.....	306
Engine Immobilizer	
See: Passive Anti-Theft System.....	67
Engine Oil Check.....	303
Adding Engine Oil.....	303
Engine Oil Dipstick.....	303
Engine Specifications.....	361
Drivebelt Routing.....	361
Entertainment.....	453
AM/FM Radio.....	455
Bluetooth Audio.....	468
Browsing Device Content.....	453
CD.....	464
Line In.....	469
SD Card Slot and USB Port.....	465
SIRIUS® Satellite Radio (If Activated).....	460
Supported Media Players, Formats and Metadata Information.....	468
Environment.....	14
EPB	
See: Electric Parking Brake.....	191
Essential Towing Checks.....	261
Before Towing a Trailer.....	266
Hitches.....	262
Launching or Retrieving a Boat or Personal Watercraft (PWC).....	267
Safety Chains.....	262
Trailer Brakes.....	262
Trailer Lamps.....	266
Trailer Towing Connector.....	261
Using a Step Bumper.....	266
When Towing a Trailer.....	266
Event Data Recording	
See: Data Recording.....	9
Export Unique Options.....	13
Extended Service Plan (ESP).....	499
EXTENDED SERVICE PLAN (CANADA ONLY).....	500
EXTENDED SERVICE PLAN (U.S. Only).....	499
Exterior Mirrors.....	89
360-Degree Camera.....	92
Auto-dimming Feature (if equipped).....	91
Blind Spot Information System.....	93
Clearance Lamps.....	92
Direction Indicator Mirrors.....	92
Fold-Away Exterior Mirrors.....	90
Heated Exterior Mirrors.....	91
Integrated Blind Spot Mirror (If Equipped).....	92
Memory Mirrors.....	91
Power Exterior Mirrors.....	89
Power-Folding Mirrors.....	90
Puddle Lamps.....	92
Spot Lamps.....	92
F	
Fastening the Seatbelts.....	34
Fastening the Cinch Tongue.....	35
Rear Inflatable Safety Belt.....	37
Safety Belt Extension Assembly.....	38
Safety Belt Locking Modes.....	36
Using Safety Belts During Pregnancy.....	35
Using the Safety Belt with Cinch Tongue (Front Center Seat).....	34
Floor Mats.....	273
Fog Lamps - Front	
See: Front Fog Lamps.....	84
Foot Pedals	
See: Adjusting the Pedals.....	77
Ford Credit.....	11
(U.S. Only).....	11
Four-Wheel Drive.....	180
Front Fog Lamps.....	84
Front Passenger Sensing System.....	45
Front Seat Armrest.....	149
Fuel and Refueling.....	166

Index

Fuel Consumption.....	170
Calculating Fuel Economy.....	171
Filling the Tank.....	170
Fuel Filter.....	309
Fuel Quality.....	167
Choosing the Right Fuel With a Flex Fuel Vehicle (If Equipped).....	167
Choosing the Right Fuel Without a Flex Fuel Vehicle (If Equipped).....	167
Octane Recommendations.....	167
Fuel Shutoff.....	278
Fuses.....	289
Fuse Specification Chart.....	289
Passenger Compartment Fuse Panel.....	294
Power Distribution Box.....	289
G	
Garage Door Opener See: Universal Garage Door Opener.....	150
Gauges.....	95
Engine Coolant Temperature Gauge.....	97
Engine Oil Pressure Gauge.....	97
Fuel Gauge.....	97
Information Display.....	98
Transmission Fluid Temperature Gauge.....	98
Type 1 and 2.....	95
Type 3.....	96
General Information on Radio Frequencies.....	51
Intelligent Access.....	51
General Maintenance Information.....	501
Multi-Point Inspection.....	503
Owner Checks and Services.....	502
Protecting Your Investment.....	501
Why Maintain Your Vehicle?.....	501
Why Maintain Your Vehicle at Your Dealership?.....	501
Getting Assistance Outside the U.S. and Canada.....	285
Getting the Services You Need.....	282
Away From Home.....	282

H

Handbrake See: Parking Brake.....	190
Hazard Warning Flashers.....	278
HDC See: Using Hill Descent Control.....	199
Headlamp Adjusting See: Adjusting the Headlamps.....	312
Head Restraints.....	139
Adjusting the Head Restraint.....	140
Heated Seats.....	146
Rear Heated Seats.....	147
Heated Windows and Mirrors.....	137
Heated Exterior Mirror.....	137
Heated Rear Window.....	137
Heating See: Climate Control.....	131
Hill Start Assist.....	193
Switching the System On and Off.....	194
Using Hill Start Assist.....	193
Hints on Controlling the Interior Climate.....	134
Cooling the Interior Quickly.....	136
General Hints.....	134
Heating the Interior Quickly.....	135
Recommended Settings for Cooling.....	136
Recommended Settings for Heating.....	136
Side Window Defogging in Cold Weather.....	137
Hints on Driving With Anti-Lock Brakes.....	190
Hood Lock See: Opening and Closing the Hood.....	298
I	
Ignition Switch.....	158
In California (U.S. Only).....	283
Information Display Control.....	76
Information Displays.....	103
General Information.....	103

Index

Information.....	476	Installing Child Restraints.....	16
911 Assist.....	482	Child Seats.....	16
Alerts.....	482	Combining Safety Belt and LATCH Lower Anchors for Attaching Child Safety Seats.....	25
Calendar.....	482	Front Seat Tether Strap Attachment (Regular Cab).....	26
Sirius Travel Link.....	479	Rear Seat Tether Strap Attachment (Crew Cab and Super Cab).....	27
SYNC Services (If Equipped, United States Only).....	476	Use of Inboard Lower Anchors from the Outboard Seating Positions (Center Seating Use).....	24
Vehicle Health Report (If Equipped, United States Only).....	484	Using Inflatable Safety Belts (Rear Seat Outboard Positions).....	21
Information Messages.....	118	Using Lap and Shoulder Belts (Except Front Center Position of Super Cab and Crew Cab).....	17
4WD.....	130	Using Lap and Shoulder Belts (Front Center Position of Super Cab and Crew Cab).....	19
Active Park.....	118	Using Lower Anchors and Tethers for Children (LATCH).....	23
Adaptive Cruise Control.....	119	Using Tether Straps.....	25
AdvanceTrac and Traction Control.....	119	Instrument Cluster.....	95
Airbag.....	120	Instrument Lighting Dimmer.....	81
Alarm and Security.....	120	Interior Lamps.....	85
Battery and Charging System.....	121	Front Interior Lamps.....	85
Blind Spot Information and Cross Traffic Alert System.....	121	Rear Interior Lamps.....	87
Collision Warning System.....	122	Interior Mirror.....	93
Doors and Locks.....	122	Auto-Dimming Mirror.....	93
Driver Alert.....	122	Introduction.....	7
Drivetrain.....	122	J	
Engine.....	123	Jump Starting the Vehicle.....	279
Fuel.....	123	Connecting the Jumper Cables.....	279
Keys and Intelligent Access.....	123	Jump Starting.....	280
Lane Keeping System.....	124	Preparing Your Vehicle.....	279
Maintenance.....	125	Removing the Jumper Cables.....	280
MyKey.....	125	K	
Off Road.....	126	Keyless Entry.....	64
Park Aid.....	127	SECURICODE™ KEYLESS ENTRY KEYPAD.....	64
Park Brake.....	127	Keyless Starting.....	158
Power Steering.....	128	Ignition Modes.....	159
Remote Start.....	128	Keys and Remote Controls.....	51
Seats.....	128		
Starting System.....	128		
Tire Pressure Monitoring System.....	129		
Trailer.....	129		

Index

L

Lane Keeping System.....	220
Switching the System On and Off.....	221
Lighting Control.....	80
Headlamp Flasher.....	80
High Beams.....	80
Lighting.....	80
Load Carrying.....	233
Load Limit.....	233
Special Loading Instructions for Owners of Pick-up Trucks and Utility-type Vehicles.....	239
Vehicle Loading - with and without a Trailer.....	233
Locking and Unlocking.....	62
Activating Intelligent Access.....	63
Autolock and Autounlock.....	64
Battery Saver.....	64
Illuminated Entry.....	64
Power Door Locks.....	62
Remote Control.....	62
Smart Unlock.....	63
Smart Unlocks for Intelligent Access Keys.....	63
Locks.....	62
Lug Nuts	
See: Changing a Road Wheel.....	352

M

Maintenance.....	298
General Information.....	298
Manual Climate Control.....	131
Manual Seats.....	141
Manual Lumbar	142
Moving the Seat Backward and Forward.....	141
Recline Adjustment.....	142
Media Hub.....	401
Memory Function.....	144
Easy Entry and Exit Feature.....	145
Linking a PreSet Position to your Remote Control or Intelligent Access Key.....	145
Saving a PreSet Position.....	145
Message Center	
See: Information Displays.....	103

Mirrors

See: Heated Windows and Mirrors.....	137
See: Windows and Mirrors.....	88
Mobile Communications Equipment.....	13
Moonroof.....	93
Bounce-Back.....	94
Opening and Closing the Moonroof.....	94
Motorcraft Parts.....	362
MyFord Touch™.....	436
General Information.....	436
MyKey Troubleshooting.....	60
MyKey™.....	57
Principle of Operation.....	57

N

Navigation.....	488
cityseekr.....	490
Map Mode.....	492
Navigation Map Updates.....	495
Navigation Voice Commands.....	495
Point of Interest (POI) Categories.....	489
Quick-touch Buttons.....	494
Setting a Destination.....	488
Setting Your Navigation Preferences.....	491
Normal Scheduled Maintenance.....	504
Intelligent Oil-Life Monitor.....	504
Normal Maintenance Intervals.....	505

O

Oil Check

See: Engine Oil Check.....	303
Opening and Closing the Hood.....	298
Ordering Additional Owner's Literature.....	286
Obtaining a French Owner's Manual.....	287
Overhead Console.....	157

P

Parking Aid.....	201
Rear Sensing System.....	201
Parking Aids.....	201
Parking Brake.....	190
Passive Anti-Theft System.....	67
SecuriLock™.....	67

Index

PATS	
See: Passive Anti-Theft System.....	67
Pedals.....	77
Perchlorate.....	11
Personal Safety System™.....	42
How Does the Personal Safety System Work?.....	42
Phone.....	470
Making Calls.....	472
Pairing Subsequent Phones.....	471
Pairing Your Phone for the First Time.....	471
Phone Menu Options.....	472
Phone Settings.....	474
Phone Voice Commands.....	474
Receiving Calls.....	472
Text Messaging.....	473
Post-Crash Alert System.....	281
Power Door Locks	
See: Locking and Unlocking.....	62
Power Running Boards.....	71
Power Seats.....	142
Multi-Contour Front Seats With Active Motion.....	143
Power Lumbar.....	143
Power Steering Fluid Check.....	309
Power Windows.....	88
Accessory Delay.....	89
Bounce-Back.....	88
One-Touch Up or Down.....	88
Power Sliding Back Window.....	89
Window Lock.....	89
Protecting the Environment.....	14
R	
Rear Axle.....	188
Rear Seat Armrest.....	149
Rear Seats.....	146
Folding Up the Rear Seat Cushion.....	146
Returning the Seat to the Seating Position.....	146
Rear View Camera.....	206
Using the Rear View Camera System.....	207
Rear View Camera	
See: Rear View Camera.....	206
Recommended Towing Weights.....	250
Calculating the Maximum Loaded Trailer Weight for Your Vehicle.....	260
Refueling.....	169
Easy Fuel™ Capless Fuel System.....	169
Remote Control.....	51
Car Finder.....	55
Integrated Keyhead Transmitters.....	51
Intelligent Access Key.....	52
Memory Feature.....	54
Remote Start.....	55
Replacing the Battery.....	52
Sounding a Panic Alarm.....	55
Remote Start.....	138
Automatic Settings.....	138
Repairing Minor Paint Damage.....	326
Replacement Parts	
Recommendation.....	11
Collision Repairs.....	11
Scheduled Maintenance and Mechanical Repairs.....	11
Warranty on Replacement Parts.....	12
Replacing a Lost Key or Remote Control.....	56
Reporting Safety Defects (Canada Only).....	287
Reporting Safety Defects (U.S. Only).....	287
Roadside Assistance.....	277
Vehicles Sold in Canada: Getting Roadside Assistance.....	277
Vehicles Sold in Canada: Using Roadside Assistance.....	277
Vehicles Sold in the United States: Getting Roadside Assistance.....	277
Vehicles Sold in the United States: Using Roadside Assistance.....	277
Roadside Emergencies.....	277
Running-In	
See: Breaking-In.....	272
Running Out of Fuel.....	168
Refilling With a Portable Fuel Container.....	168
S	
Safety Canopy™.....	48
Safety Precautions.....	166

Index

Satellite Radio.....	397	Spot Lamps.....	84
Satellite Radio Electronic Serial Number (ESN).....	399	Cargo and Trailer Hookup Lamps.....	85
Satellite Radio Reception Factors.....	398	Stability Control.....	196
SIRIUS® Satellite Radio Service.....	398	Principle of Operation.....	196
Troubleshooting.....	399	Starter Switch	
Scheduled Maintenance Record.....	510	See: Ignition Switch.....	158
Scheduled Maintenance.....	501	Starting a Gasoline Engine.....	159
Seatbelt Height Adjustment.....	38	Automatic Engine Shutdown.....	161
Seatbelt Reminder.....	39	Failure to Start.....	160
Belt-Minder™.....	39	Guarding Against Exhaust Fumes.....	162
Seatbelts.....	33	Important Ventilating Information.....	162
Principle of Operation.....	33	Stopping the Engine When Your Vehicle is Moving.....	161
Seatbelt Warning Lamp and Indicator		Stopping the Engine When Your Vehicle is Stationary.....	161
Chime.....	39	Vehicles with an Ignition Key.....	159
Conditions of operation.....	39	Vehicles with Keyless Start.....	160
Seats.....	139	Starting and Stopping the Engine.....	158
Security.....	67	General Information.....	158
Settings.....	443	Steering.....	229
Clock.....	443	Electric Power Steering.....	229
Display.....	444	Steering Wheel.....	73
Settings.....	446	Storage Compartments.....	156
Sound.....	444	Sunroof	
Vehicle.....	445	See: Moonroof.....	93
Side Airbags.....	47	Sun Visors.....	93
Sitting in the Correct Position.....	139	Illuminated Vanity Mirror.....	93
Snow Chains		Supplementary Restraints System.....	43
See: Using Snow Chains.....	346	Principle of Operation.....	43
Snowplowing.....	274	Symbols Glossary.....	7
Engine Temperature while Plowing.....	276	SYNC™ Applications and Services.....	416
Installing the Snowplow.....	274	911 Assist.....	416
Operating the Vehicle with the Snowplow Attached.....	275	SYNC Mobile Apps.....	418
Outside Air Temperature While Plowing.....	276	SYNC™.....	402
Snowplowing with your Airbag Equipped Vehicle.....	275	General Information.....	402
Snowplow Mode.....	275	SYNC™ Troubleshooting.....	427
Transmission Operation while Plowing.....	276		
Special Notices.....	12		
New Vehicle Limited Warranty.....	12		
Special Instructions.....	12		
Special Operating Conditions Scheduled Maintenance.....	507		
Exceptions.....	509		
Speed Control			
See: Cruise Control.....	212		

Index

T

Tailgate.....	239
Bed Extender.....	243
Bed Ramp.....	245
BoxLink™ Cleats.....	244
Box Side Step.....	242
Electronic Tailgate Opening.....	240
Manual Tailgate Opening.....	240
Tailgate Lock.....	239
Tailgate Removal.....	241
Tailgate Step.....	241
Technical Specifications	
See: Capacities and Specifications.....	361
Terrain Response.....	199
Principle of Operation.....	199
The Better Business Bureau (BBB) Auto Line Program (U.S. Only).....	284
Tire Care.....	331
Glossary of Tire Terminology.....	332
Information About Uniform Tire Quality Grading.....	331
Information Contained on the Tire	
Sidewall.....	333
Temperature A B C.....	332
Traction AA A B C.....	331
Treadwear.....	331
Tire Pressure Monitoring System.....	347
Changing Tires With a Tire Pressure Monitoring System.....	348
Understanding Your Tire Pressure Monitoring System.....	348
Tires	
See: Wheels and Tires.....	329
Towing a Trailer.....	249
Load Placement.....	249
Towing Points.....	268
Towing the Vehicle on Four	
Wheels.....	269
Emergency Towing.....	269
Recreational Towing.....	269
Towing.....	249
Traction Control.....	195
Principle of Operation.....	195
Trailer Sway Control.....	250
Transfer Case Fluid Check.....	308
Transmission Code Designation.....	364
Transmission.....	174

Transmission

See: Transmission.....	174
Transporting the Vehicle.....	269
Type Approvals.....	535
RF Certification Logos for Tire Pressure Monitoring Sensor(s).....	535

U

Under Hood Overview - 2.7L	
EcoBoost™.....	299
2.7L EcoBoost.....	299
Under Hood Overview - 3.5L	
EcoBoost™.....	300
Under Hood Overview - 3.5L.....	301
Under Hood Overview - 5.0L.....	302
Unique Driving Characteristics.....	164
Universal Garage Door Opener.....	150
HomeLink Wireless Control System.....	150
USB Port.....	400
Using Adaptive Cruise Control.....	213
Blocked Sensor.....	218
Changing the Set Speed.....	216
Detection Issues.....	217
Disengaging the System.....	216
Following a Vehicle.....	214
Hilly Condition Usage.....	217
Low Speed Automatic Cancellation.....	217
Overriding the System.....	216
Resuming the Set Speed.....	216
Setting a Speed.....	214
Setting the Gap Distance.....	215
Switching the System Off.....	217
Switching the System On.....	214
Switching to Normal Cruise Control.....	219
System Not Available.....	218
Using Cruise Control.....	212
Switching Cruise Control Off.....	213
Switching Cruise Control On and Off.....	212

Index

Using Four-Wheel Drive.....	180
4WD Indicator Lights.....	180
Driving Off-Road With Truck and Utility Vehicles.....	183
How Your Vehicle Differs From Other Vehicles.....	183
Using the 2-Speed Automatic 4WD System.....	181
Using the Electronic Shift on the Fly 4WD system.....	180
Using Hill Descent Control.....	199
Hill descent modes.....	199
Using MyKey With Remote Start Systems.....	60
Using Power Running Boards.....	71
Automatic Power Deploy.....	71
Automatic Power Stow.....	71
Bounce-back.....	72
Enabling and Disabling.....	71
Manual Power Deploy.....	71
Using Snow Chains.....	346
Using Stability Control.....	197
AdvanceTrac™ with Roll Stability Control™ (RSC™).....	197
Using SYNC™ With Your Media Player.....	420
Accessing Your USB Song Library.....	423
Bluetooth Devices and System Settings.....	425
Connecting Your Digital Media Player to the USB Port.....	420
Line In Audio.....	425
Media Menu Features.....	422
Media Voice Commands.....	420
USB 2.....	425
Voice Commands for Audio Sources.....	425
What's Playing?.....	420
Using SYNC™ With Your Phone.....	406
Accessing Features through the Phone Menu.....	409
Accessing Your Phone Settings.....	412
Bluetooth Devices.....	413
Making Calls.....	408
Pairing a Phone for the First Time.....	406
Pairing Subsequent Phones.....	407
Phone Options during an Active Call.....	408
Phone Voice Commands.....	407
Receiving Calls.....	408
System Settings.....	414
Text Messaging.....	410
Using Traction Control.....	195
System Indicator Lights and Messages.....	195
Using Voice Recognition.....	404
Initiating a Voice Session.....	404
System Interaction and Feedback.....	405
Utilizing the Mediation/Arbitration Program (Canada Only).....	285
V	
Vehicle Care.....	321
General Information.....	321
Vehicle Certification Label.....	363
Vehicle Identification Number.....	362
Vehicle Storage.....	327
Battery.....	328
Body.....	327
Brakes.....	328
Cooling system.....	327
Engine.....	327
Fuel system.....	327
General.....	327
Miscellaneous.....	328
Removing Vehicle From Storage.....	328
Tires.....	328
Ventilation	
See: Climate Control.....	131
VIN	
See: Vehicle Identification Number.....	362
Voice Control.....	75

Index

W

Warning Lamps and Indicators.....	98
Adaptive Cruise Control.....	98
Anti-Lock Braking System.....	98
Automatic High Beam.....	98
Auto Start-stop.....	98
Battery.....	99
Blind Spot Monitor.....	99
Brake System.....	99
Check 4X4.....	99
Cruise Control.....	99
Direction Indicator.....	99
Door Ajar.....	99
Electric Park Brake.....	99
Electronic Locking Differential.....	99
Engine Coolant Temperature.....	99
Engine Oil.....	100
Fasten Safety Belt.....	100
Four-Wheel Drive Indicators.....	100
Front Airbag.....	100
Front Fog Lamps.....	100
High Beam.....	100
Hill Descent.....	100
Low Fuel Level.....	100
Low Tire Pressure Warning.....	100
Parking Lamps.....	101
Powertrain Malfunction/Reduced Power/Electronic Throttle Control.....	101
Service Engine Soon.....	101
Sport Mode.....	101
Traction and Stability Control.....	101
Traction and Stability Control Off.....	101
Transmission Tow/Haul.....	102
Washer Fluid Check.....	309
Washers	
See: Cleaning the Exterior.....	321
See: Wipers and Washers.....	78
Waxing.....	322
Wheel Nuts	
See: Changing a Road Wheel.....	352
Wheels and Tires.....	329
General Information.....	329
Technical Specifications.....	360
Windows and Mirrors.....	88
Windshield Washers.....	79
Windshield Wipers.....	78
Speed dependent wipers (if equipped).....	78
Wiper Blades	
See: Checking the Wiper Blades.....	311
Wipers and Washers.....	78
Wrecker Towing	
See: Transporting the Vehicle.....	269